

Physiology

Fractional Flow Reserve

Under the maximal hyperemia

$$\text{FFR} = \frac{Q_{s_{\max}}}{Q_{n_{\max}}} = \frac{(\cancel{P_d} - \cancel{P_v}) / \cancel{R}}{(\cancel{P_a} - \cancel{P_v}) / \cancel{R}}$$
$$= \frac{P_d}{P_a}$$

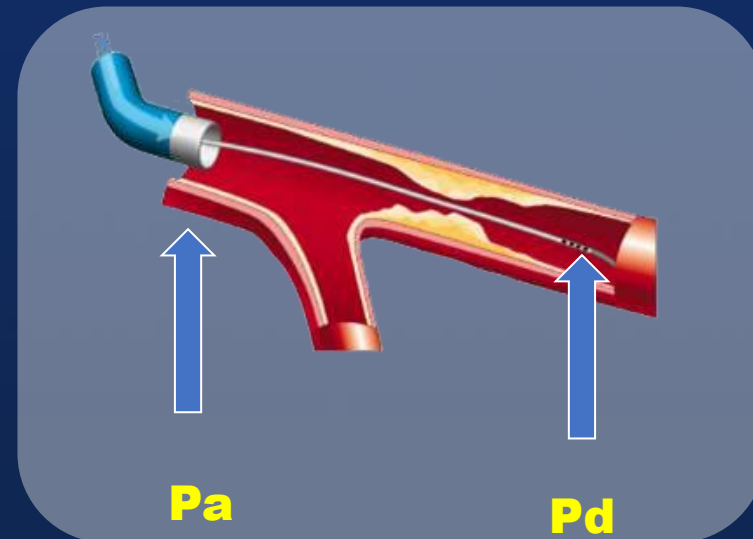

Importance of Maximum Hyperemia

$$\text{FFR} = \frac{Q_s^{\text{max}}}{Q_N^{\text{max}}}$$



$$= \frac{P_d}{P_a}$$

Maximal vasodilation

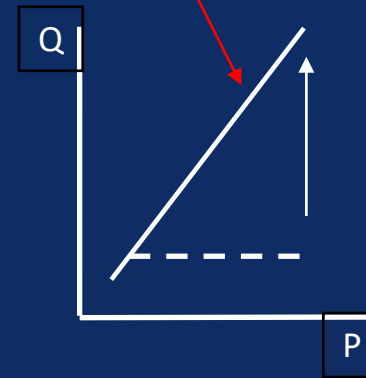

During maximal vasodilation, the ratio of *stenotic flow* to *normal flow* is proportional to their respective driving pressures.

This is exactly the definition of the FFR: the ratio of *distal coronary pressure* to *aortic pressure*.

Importance of Maximum Hyperemia

Insufficient hyperemia



Underestimation of pressure gradient



Overestimation of FFR



Underestimation of Stenosis Severity

Coronary Tandem Lesions

Multiple stenoses in series along one coronary artery

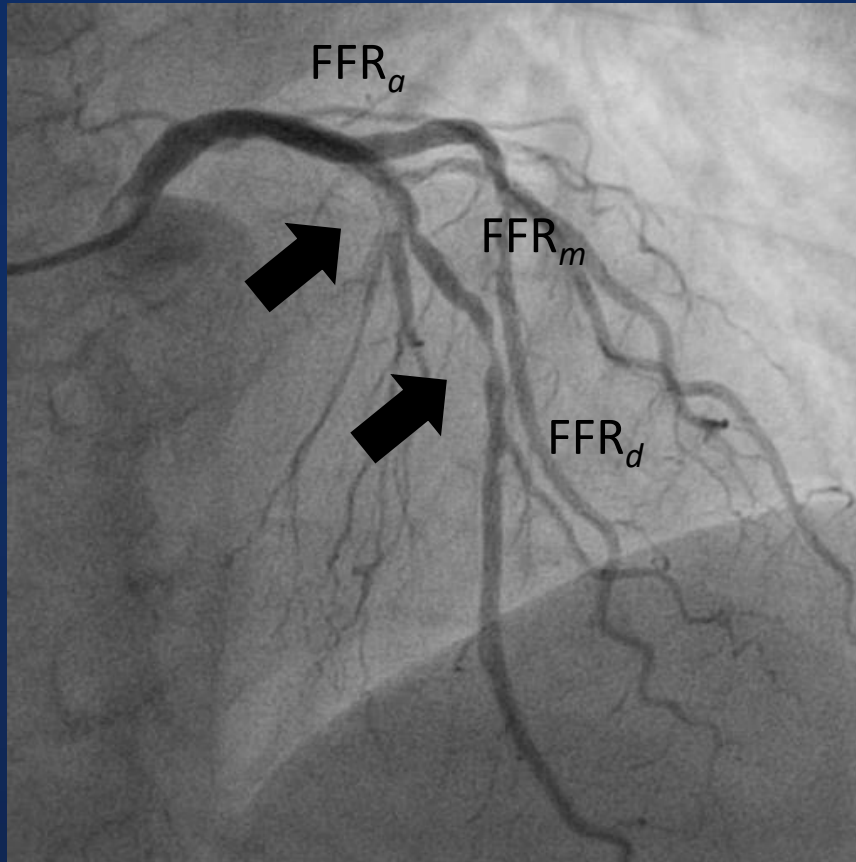

Rule of Big Delta

If $FFR_a - FFR_m > FFR_m - FFR_d$

→ Proximal Lesion Tx First

If $FFR_a - FFR_m < FFR_m - FFR_d$

→ Distal Lesion Tx First

Coronary Tandem Lesions

Multiple stenoses in series along one coronary artery

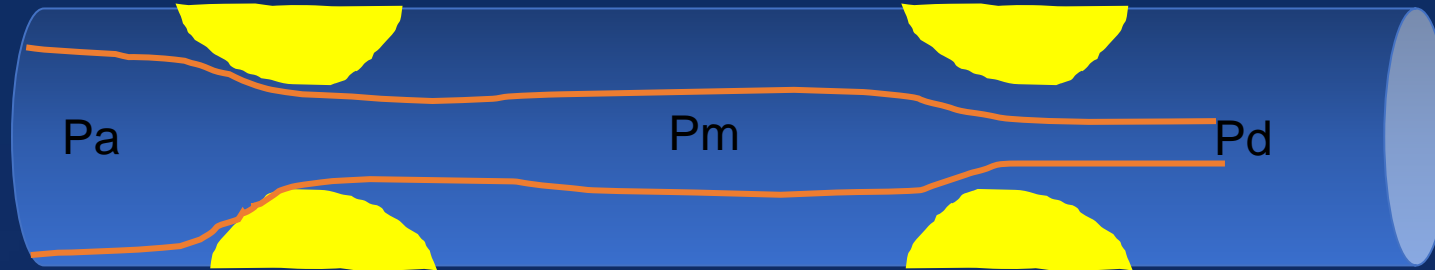

“a” lesion

$FFRa = \frac{Pa - Pm}{Pa}$
(at maximal hyperemia)

“b” lesion

$FFRb = \frac{Pd - Pm}{Pm}$ (at maximal hyperemia)

Coronary Tandem Lesions

Multiple stenoses in series along one coronary artery

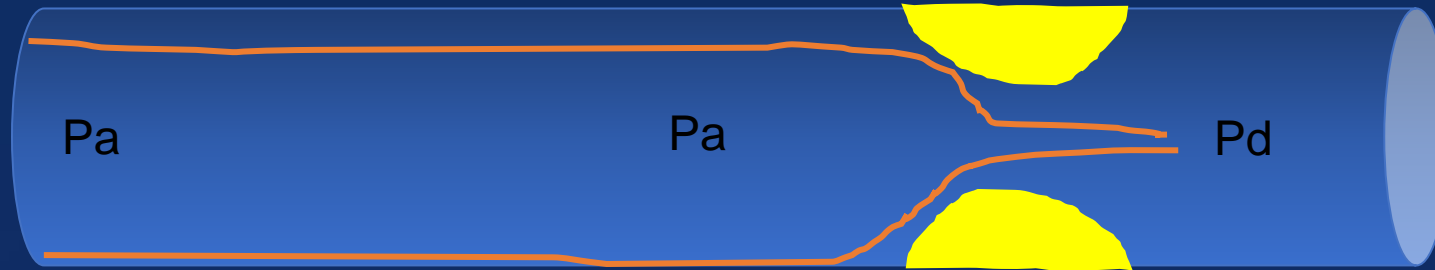

If "a" lesion is removed

FFR of "b" lesion will change

$$FFR_b = \frac{P_d - P_a}{P_a} \text{ (At maximal hyperemia)}$$

First Validation of FFR

Comparison with 3 non-invasive functional studies

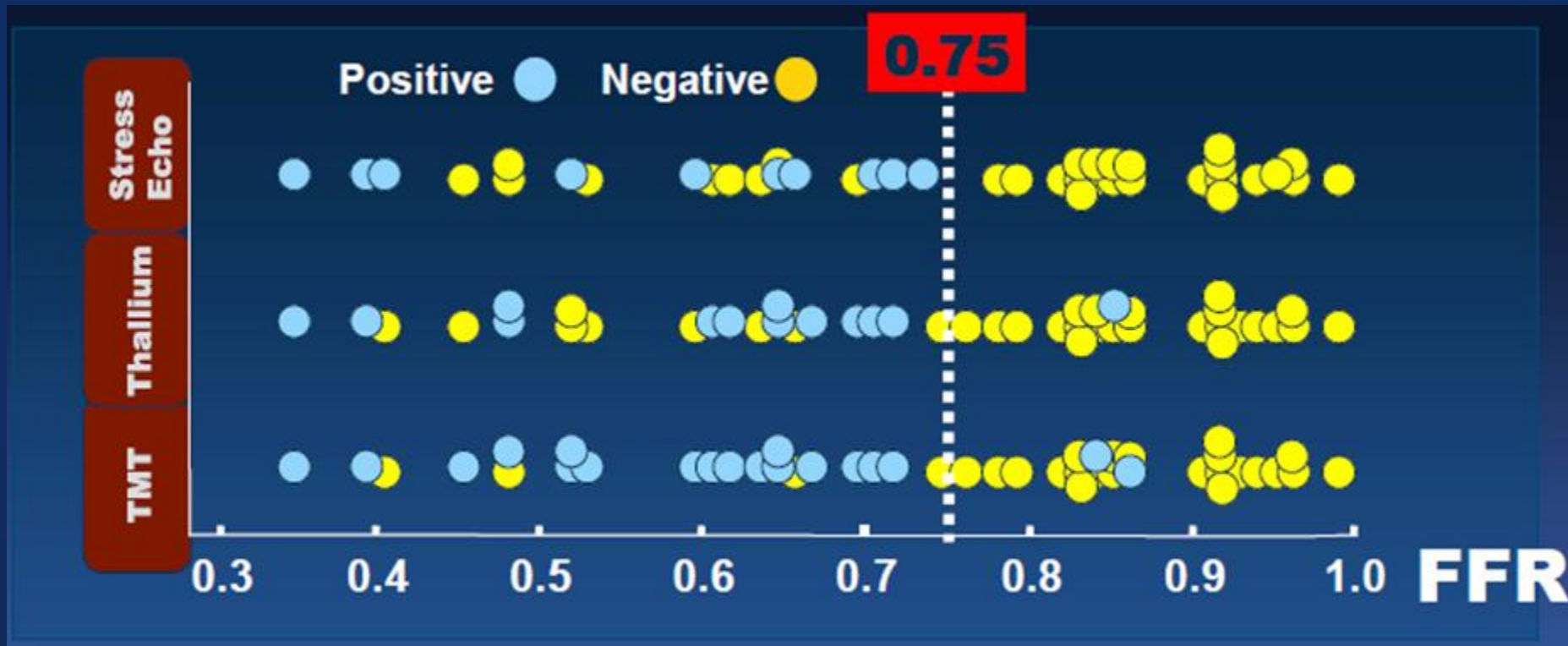

N = 45 patients

Sensitivity 88%, Specificity 100%, PPV 10%, NPV 88%

FFR Cut-Off Value

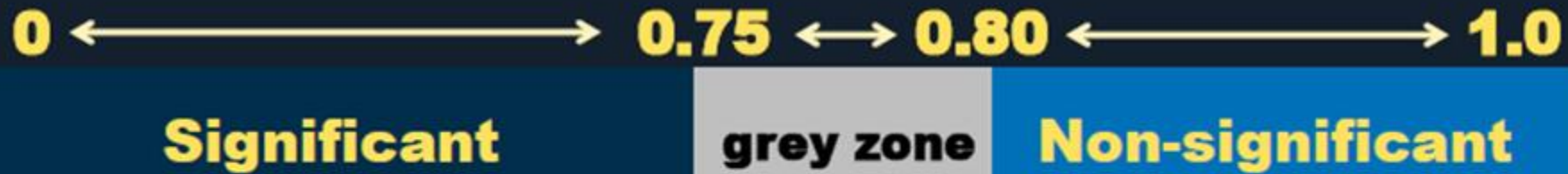

Author	Number	Stress Test	BCV	Accuracy
Pijls et al.	60	X-ECG	0.74	97
DeBruyne et al.	60	X-ECG/SPECT	0.72	85
Pijls et al.	45	X-ECG/SPECT/pacing/DSE	0.75	93
Bartunek et al.	37	DSE	0.68	90
Abe et al.	46	SPECT	0.75	91
Chamuleau et al.	127	SPECT	0.74	77
Caymaz et al.	40	SPECT	0.76	95
Jimenez-Navarro et al.	21	DSE	0.75	90
Usui et al.	167	SPECT	0.75	79
Yanagisawa et al.	167	SPECT	0.75	76
Meuwissen et al.	151	SPECT	0.74	85
DeBruyne et al.	57	MIBI-SPECT post-MI	0.78	85
Samady et al.	48	MIBI-SPECT post-MI	0.78	85

Visual-Functional Mismatch (I)

From FAME Study

■ FFR > 0.80 ■ FFR ≤ 0.80

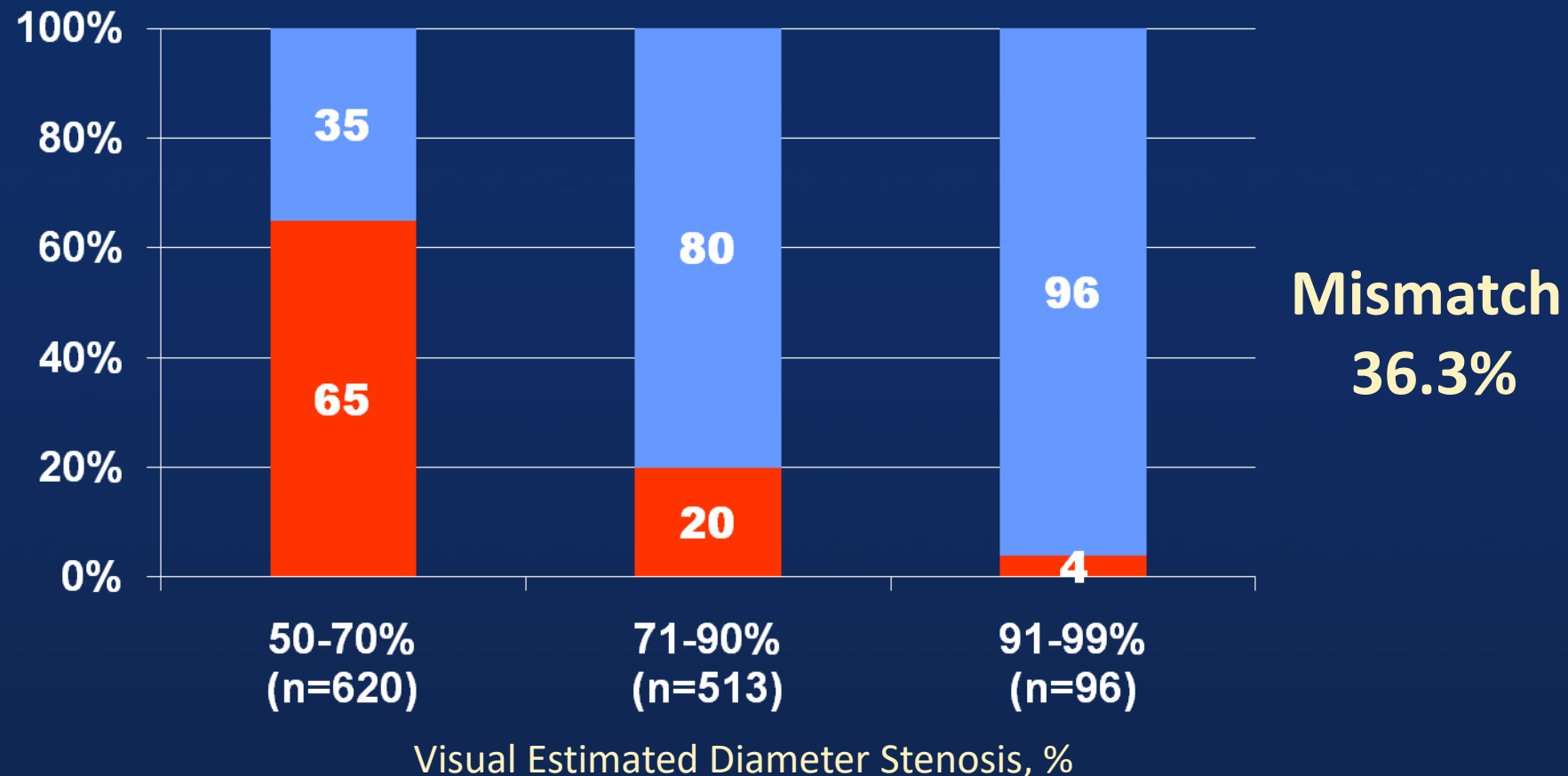

Visual-Functional Mismatch (II)

From FAME Study

Functionally Diseased Coronary Arteries

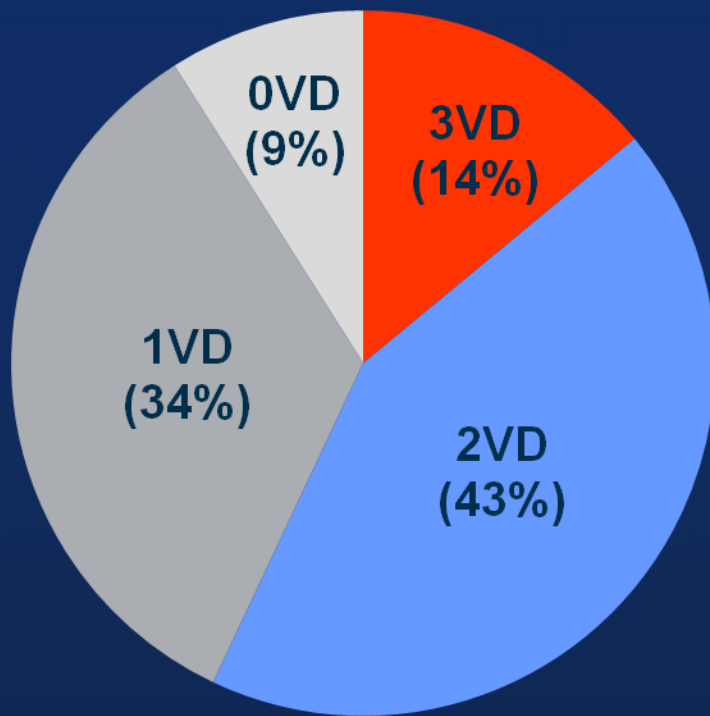

Angiographic 3VD

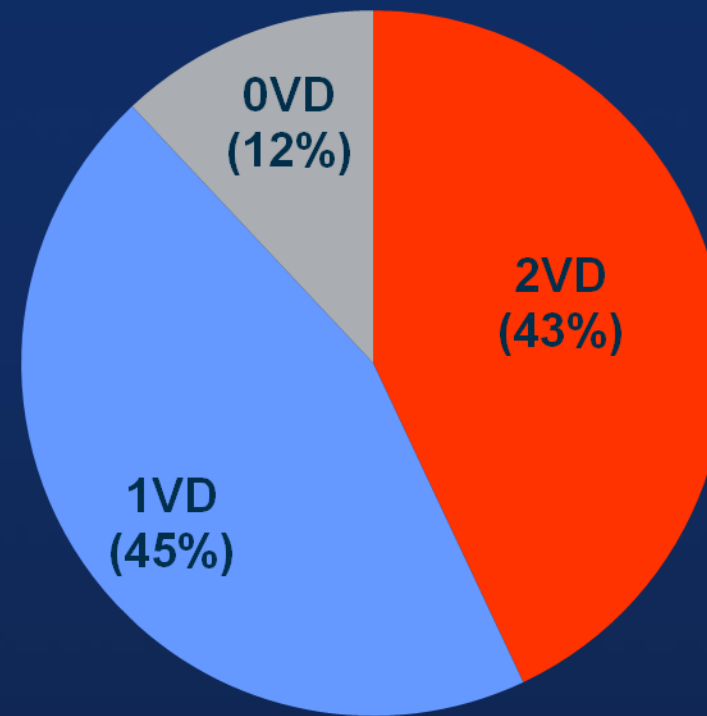

Angiographic 2VD

Visual-Functional Mismatch (III)

Functional SYNTAX Score in FAME

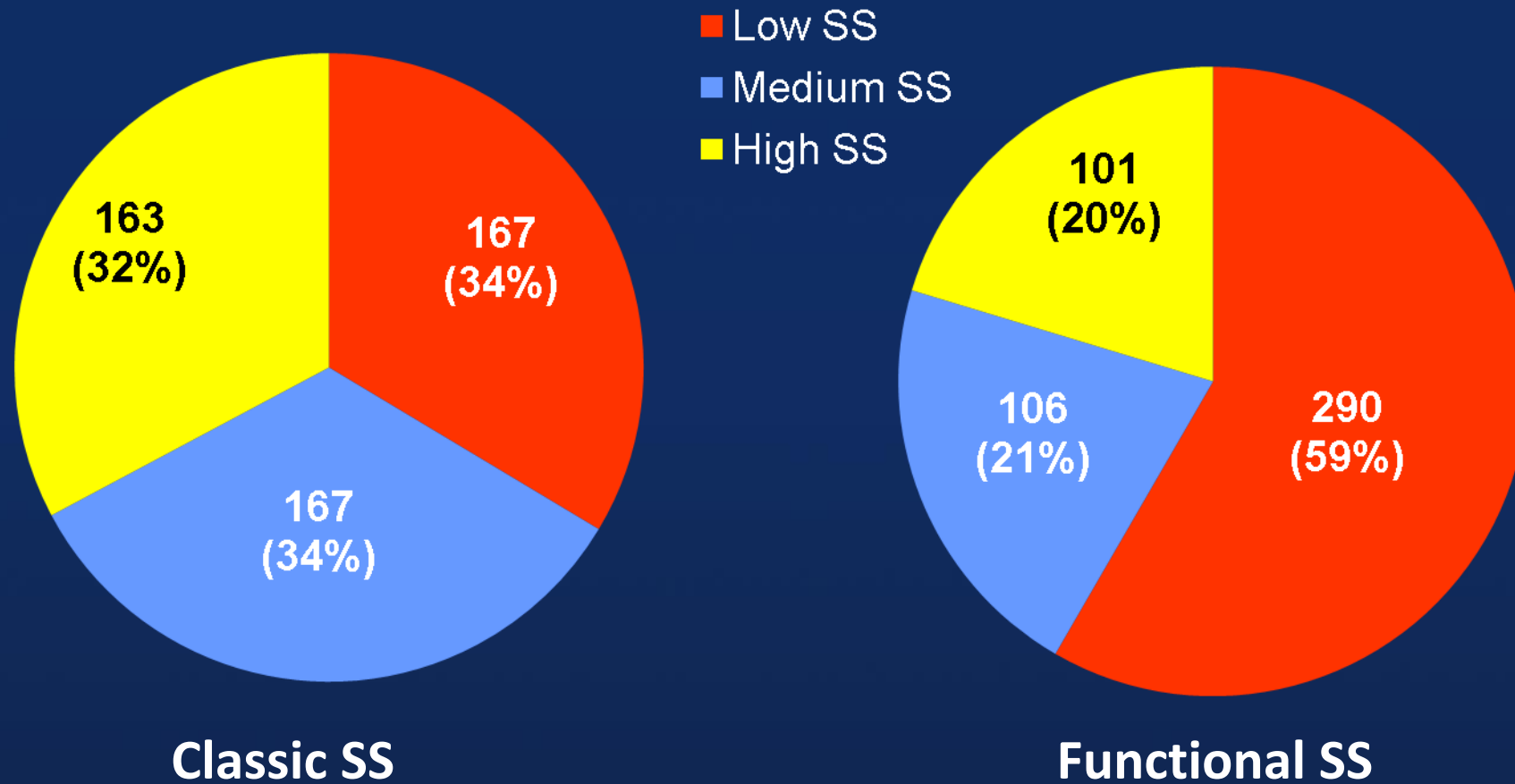

FAME @ 2yr FU

A total of 1,005 patients with multivessel CAD were randomly assigned

	Angio-Guided N=496	FFR-Guided N=509	p value
Total no. of MACE	139	105	
Individual Endpoints			
Death	19 (3.8)	13 (2.6)	0.25
MI	48 (9.7)	31 (6.1)	0.03
CABG or repeat PCI	61 (12.3)	53 (10.4)	0.35
Composite Endpoints			
Death or MI	63 (12.7)	43 (8.4)	0.03
Death, MI, CABG, or re-PCI	110 (22.2)	90 (17.7)	0.07
Total no. of MACE	139	105	

FAME @ 2yr FU

A total of 1,005 patients with multivessel CAD were randomly assigned

Death or MI

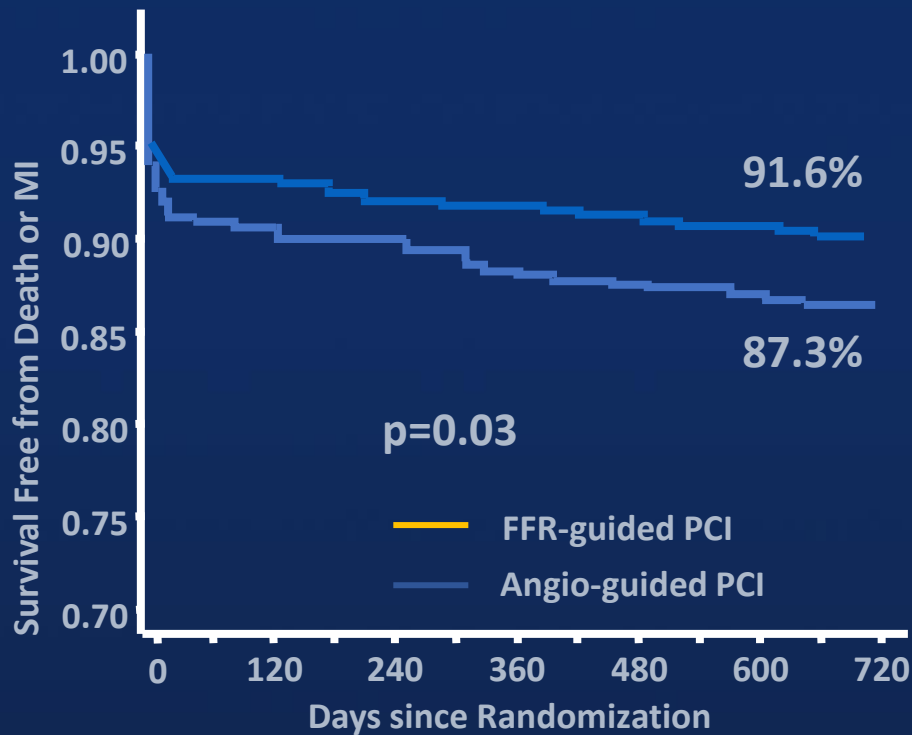

Free From Angina

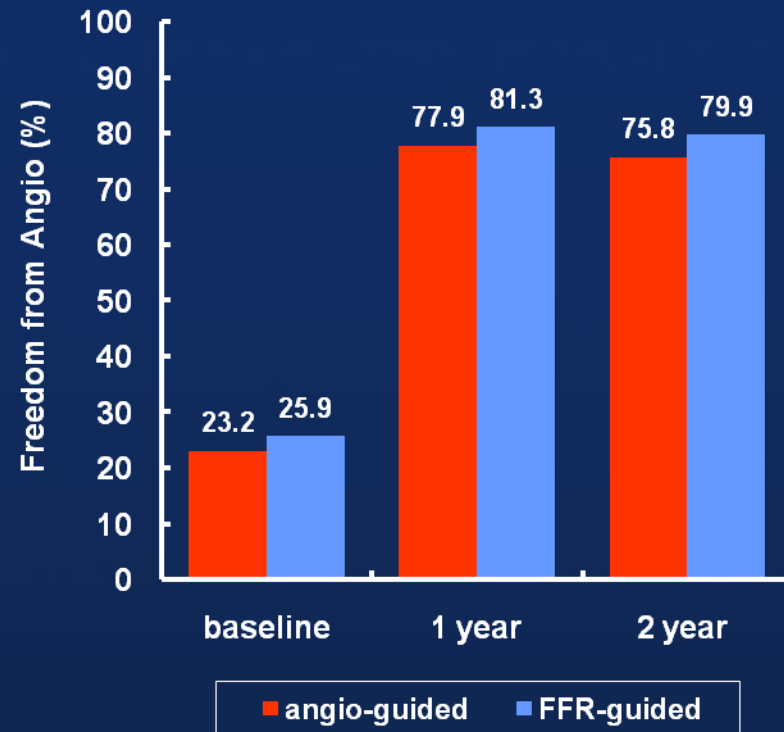

Prognostic Value of FFR on Clinical Outcomes

6,961 pts, 9,173 lesions

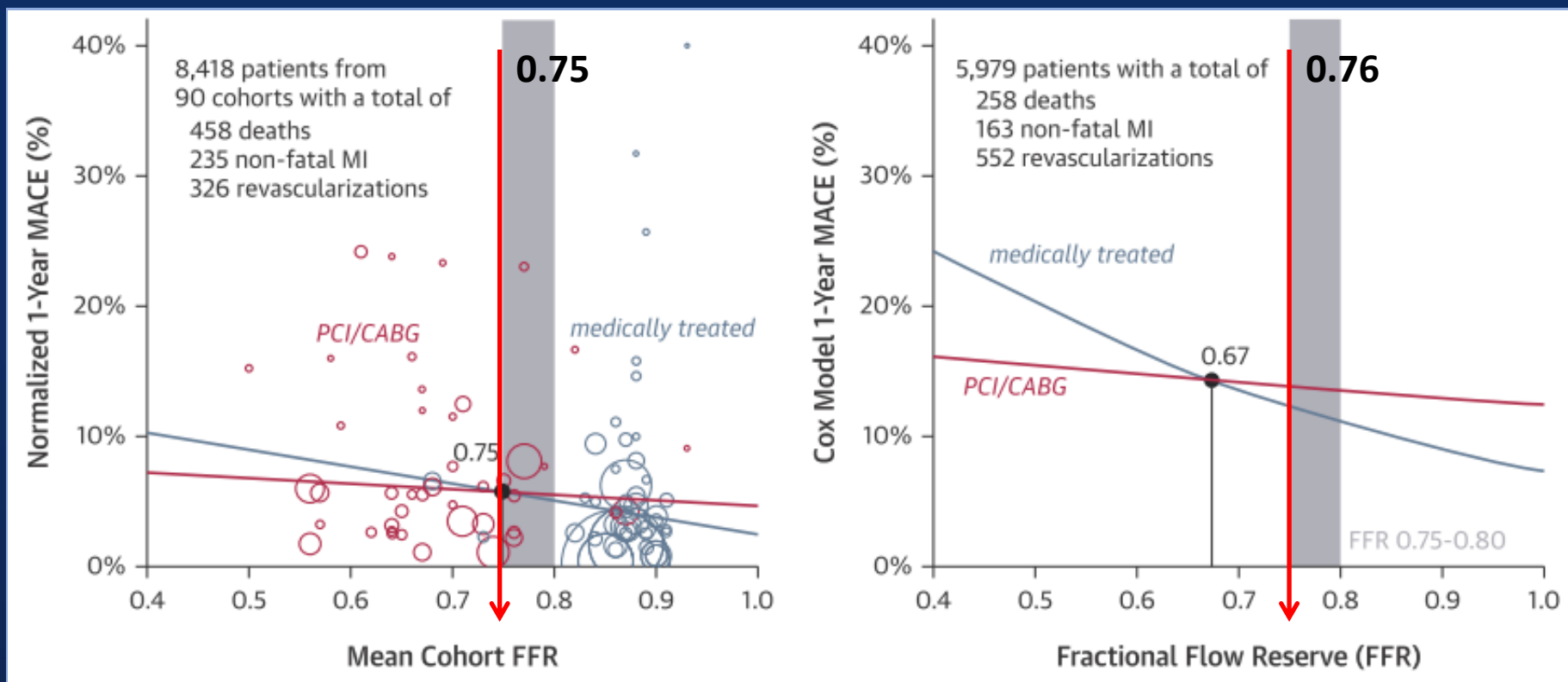

FFR guided PCI in Equivocal LMCA

- In 213 patients with an equivocal LMCA stenosis
- FFR ≥ 0.80 : Medication (n=138) vs. FFR < 0.80 : CABG (n=75)

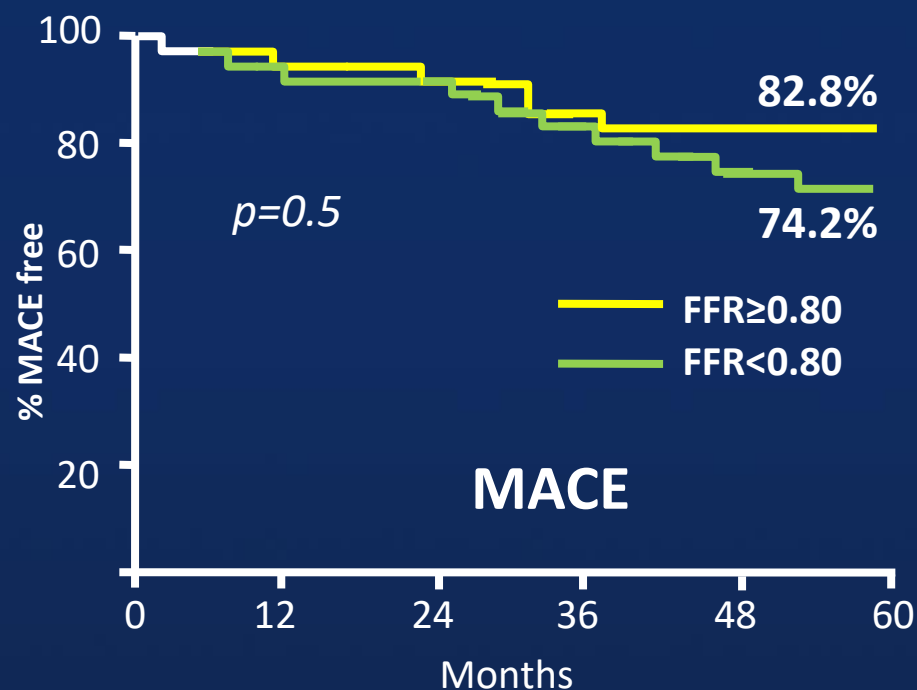
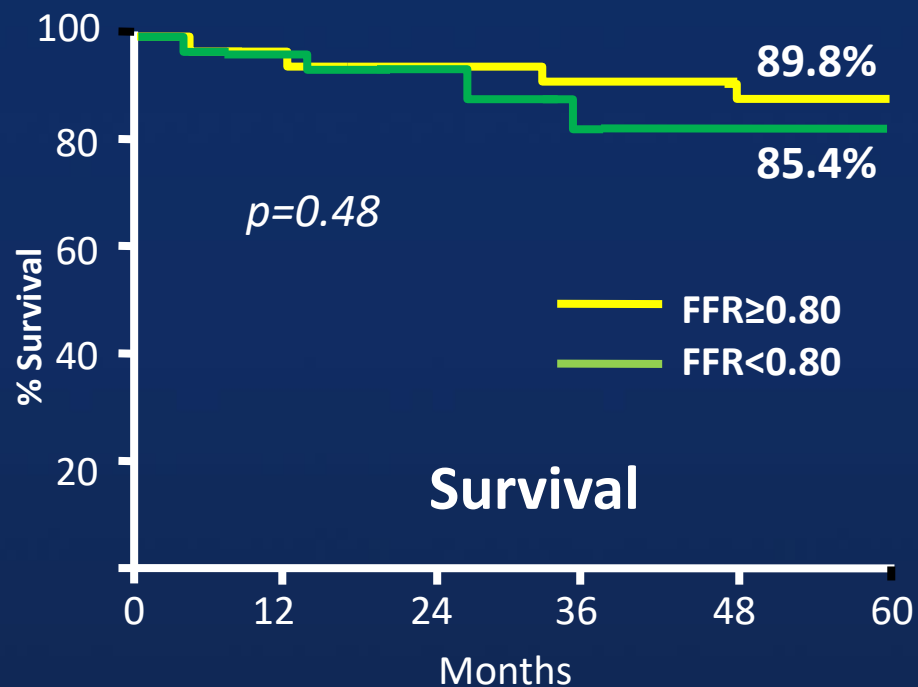

An FFR-guided strategy showed the favorable outcome.

Saving Costs and Improving Outcomes By FFR guidance

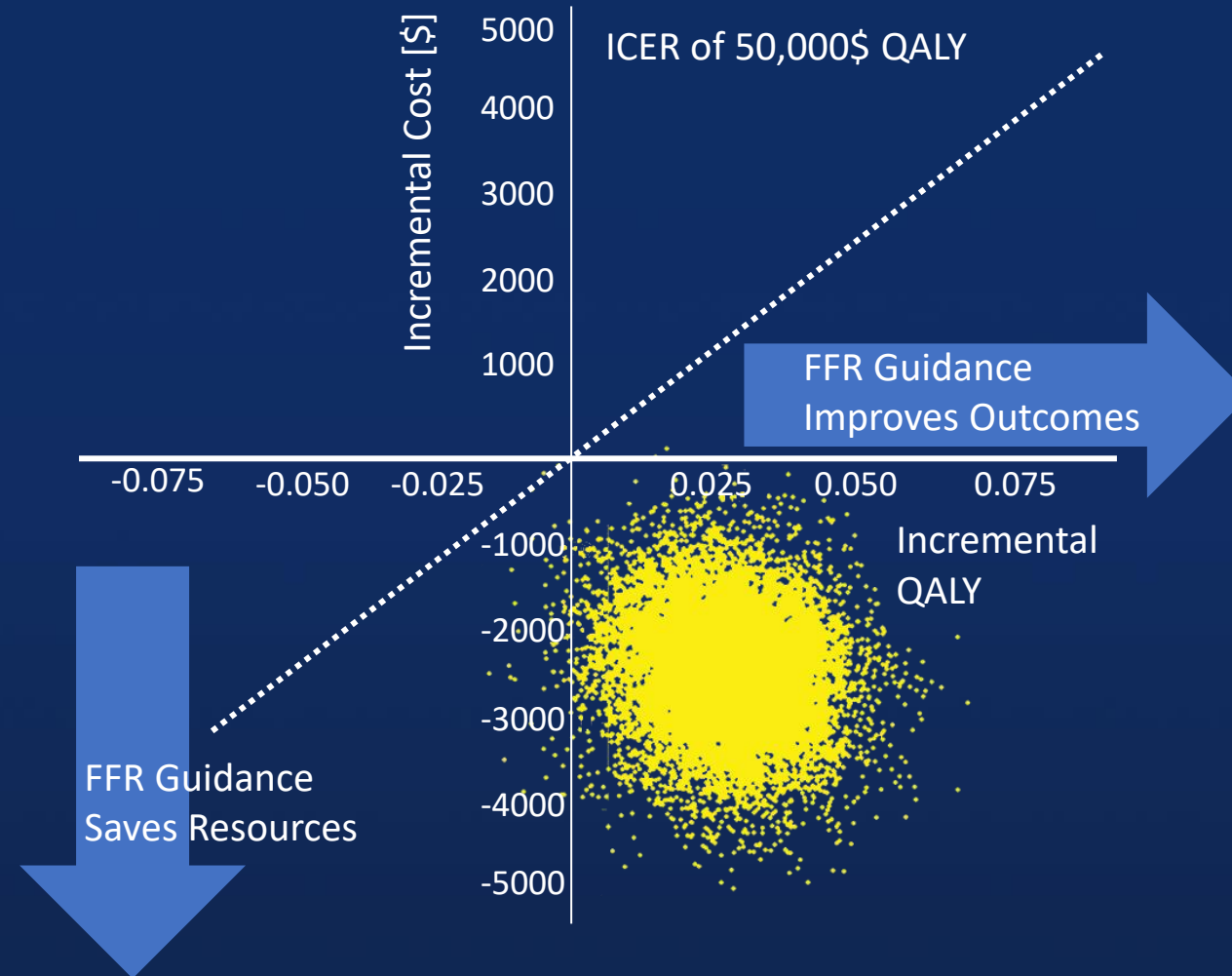

Use of IVUS vs. FFR in SB Assessment After LM Cross-over

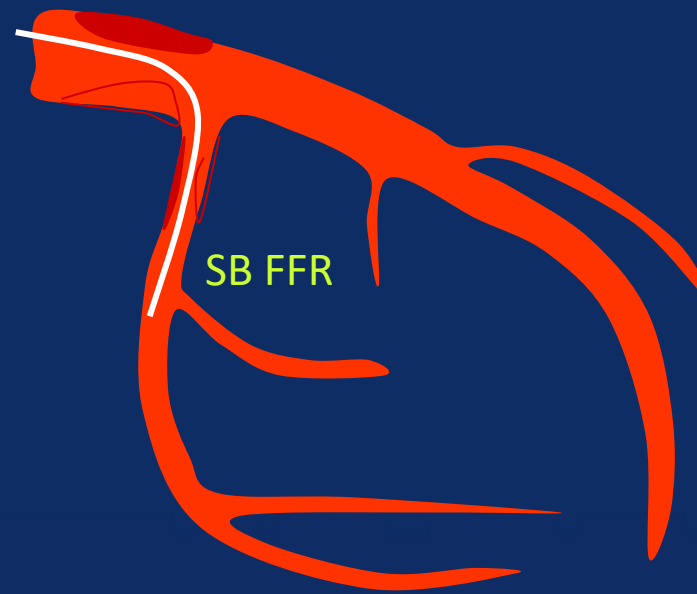

	SB-pullback IVUS	SB FFR
Advantage	<ul style="list-style-type: none"> Confirm the anatomical compromise and MLA loss Mechanism of SB jailing 	<ul style="list-style-type: none"> Confirm the functional SB compromise
Pitfalls	<ul style="list-style-type: none"> MLA-FFR mismatch No MLA criteria Low feasibility 	<ul style="list-style-type: none"> Minority - not feasible

Functional Compromise of LCX after LM Cross-Over Stenting

Preprocedural MLA and plaque burden
of poststenting LCX FFR < 0.80

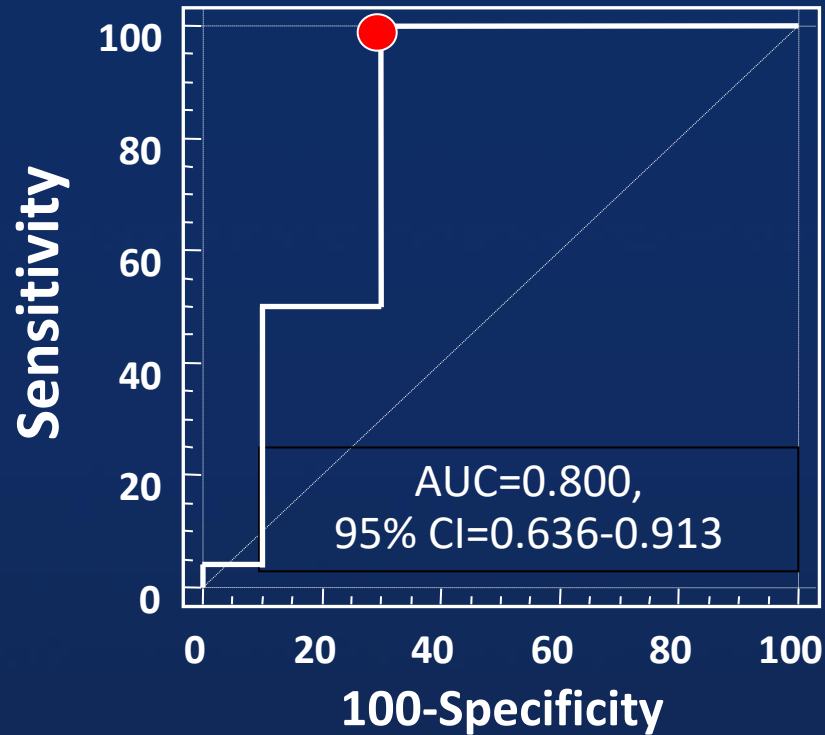

MLA 3.7 mm²

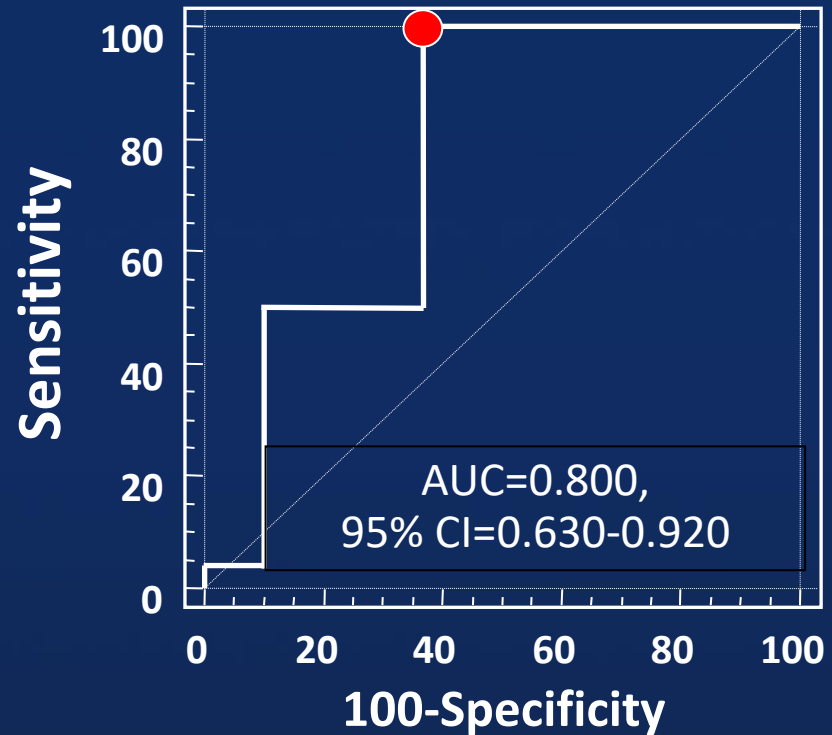

Plaque burden 56%

FFR of the Jailed Side Branch

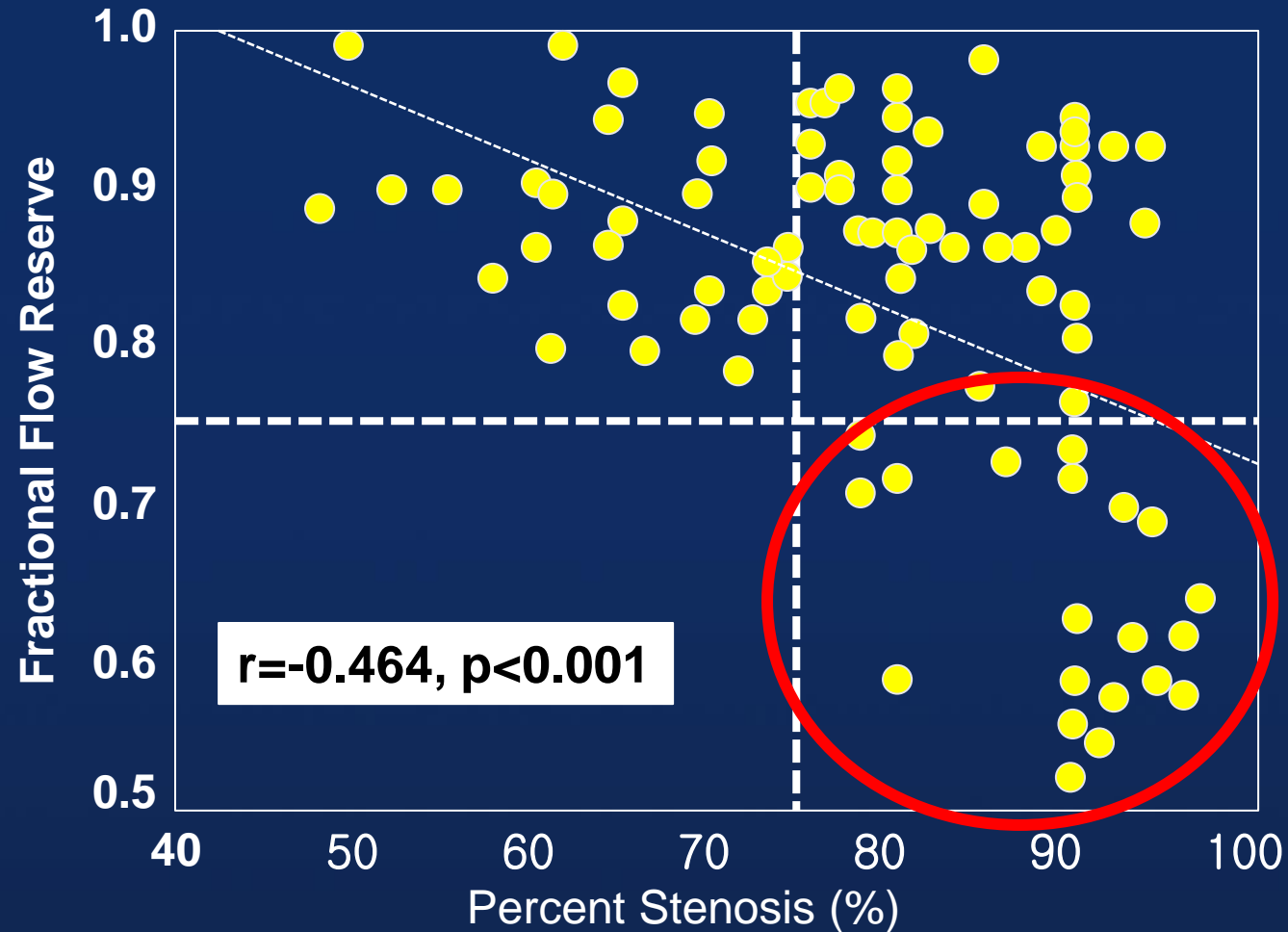

**Only 27%
among SB
with > 75% has
FFR < 0.75**

Functional LCX Compromise

In LMCA Bifurcations (LCX ostial DS<50%)

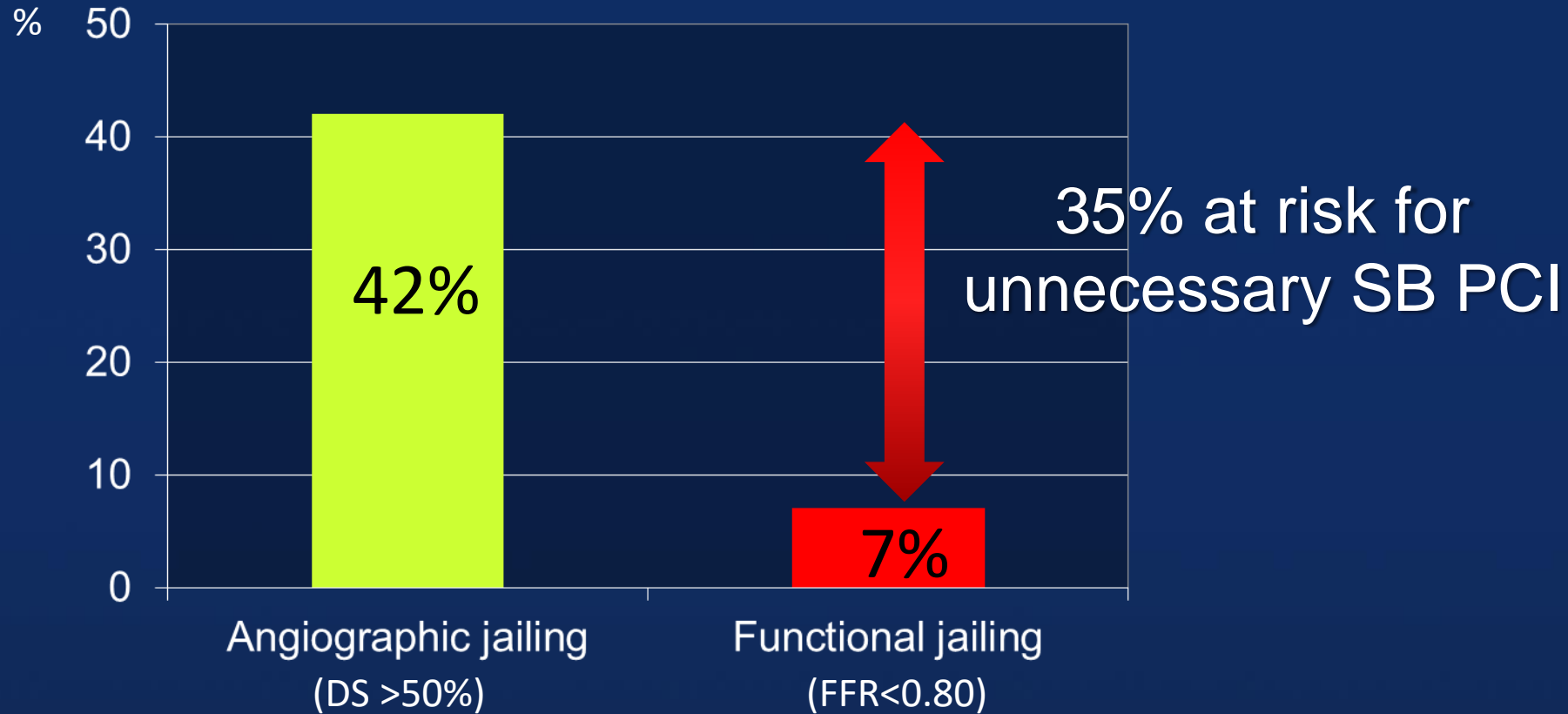

Kang et al. Catheter Cardiovasc Interv 2014;83(4):545-52

**When Pre-PCI LCX Ostial DS<50%,
Just Do Single Stent!**

LMCA Bifurcation

Post-stenting LCX Stenosis

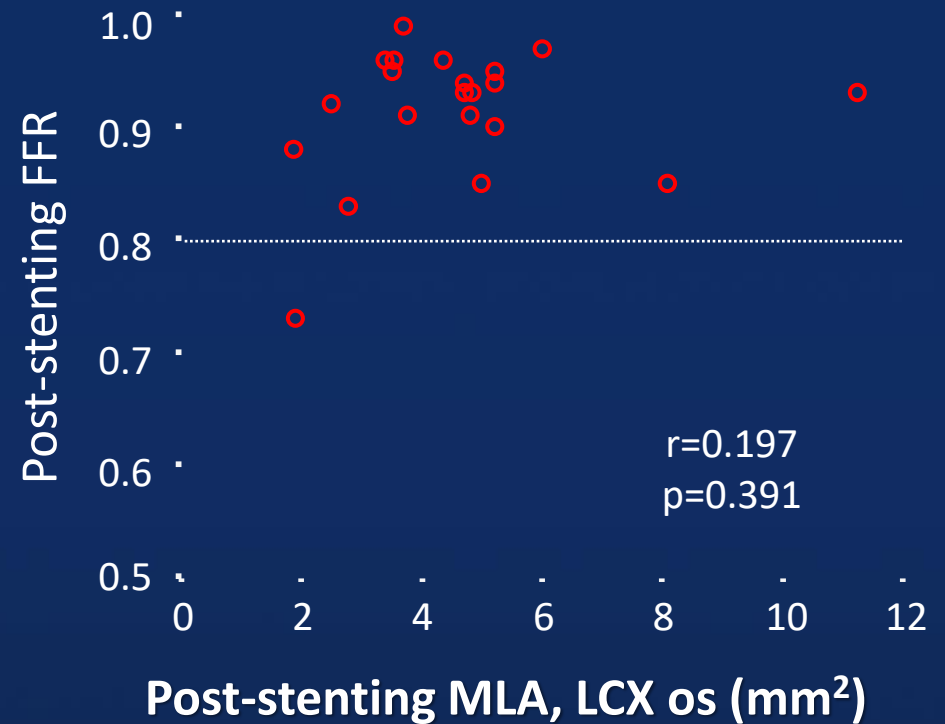
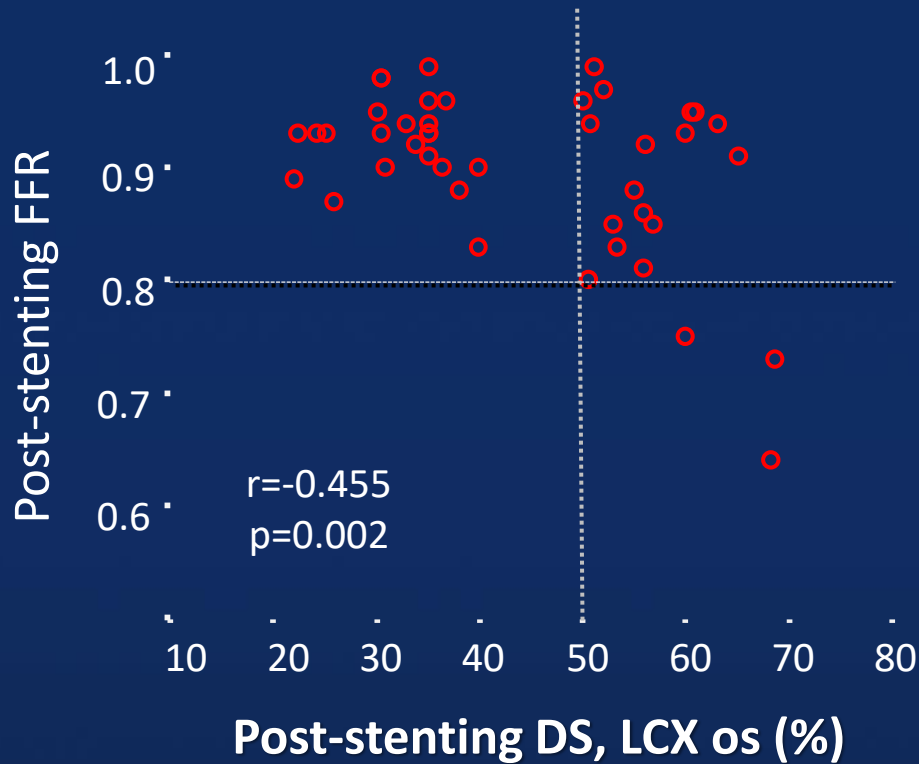

Why Mismatch?

- Lesion eccentricity of SB
- Negative remodeling of ostium
- Various size of myocardium
- Strut artifacts
- Focal carina shift

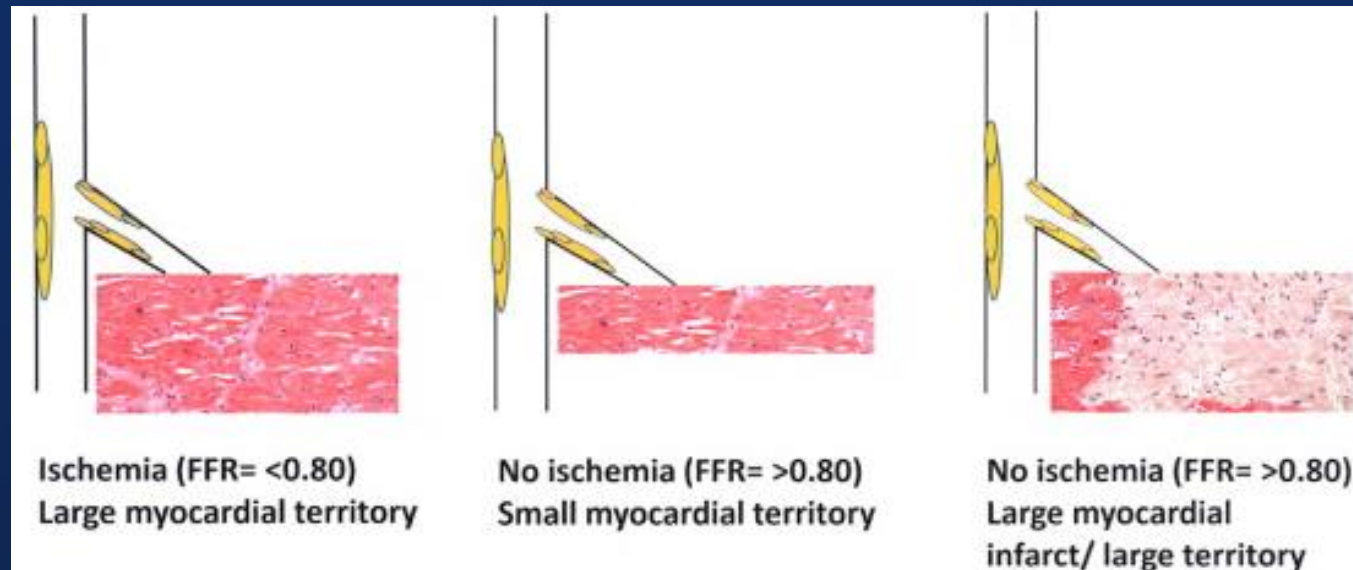

The Use of FFR

- Single Vessel Stenting
- Multivessel Stenting
- Complex Bifurcation Stenting
- Full Metal Jacket
- Deferral of PCI under OMT
- Single Vessel Stenting
- Simple Bifurcation Stenting
- Selected Stent Implantation

Between Jan 2008 and Dec 2011, 5097 pts underwent PCI at Asan Medical Center, Seoul, Korea and were followed for 1 year

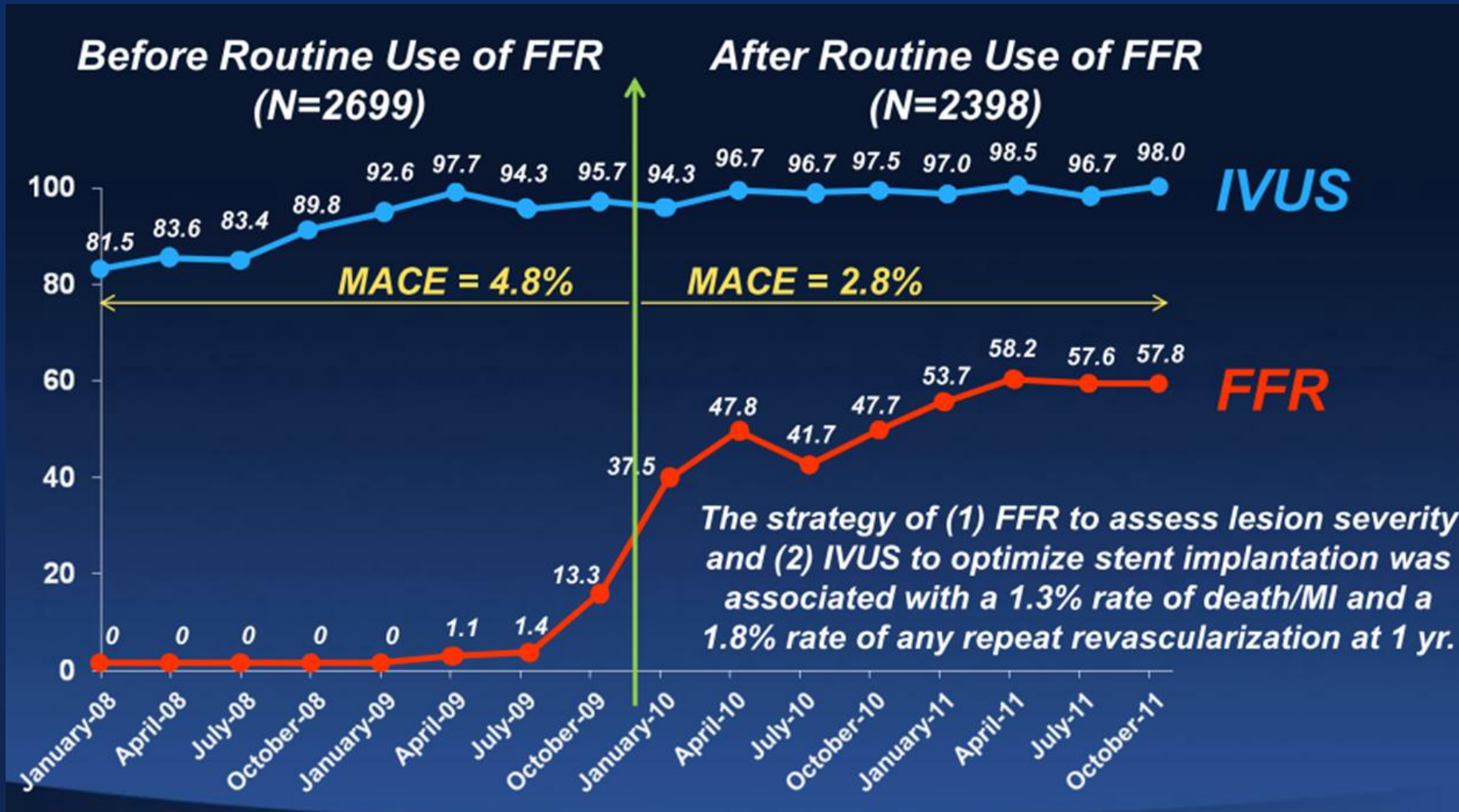

FFR-Guided Multivessel Angioplasty in SCAD

- Stable coronary artery disease
- Meta-analysis of 3 randomized control trials
 - FAME 2 study
 - DANAMI-3-PRIMULTI
 - Compare-Acute
- Primary composite end-point : cardiac death or MI
HR 0.72 (95% CI 0.54-0.96)

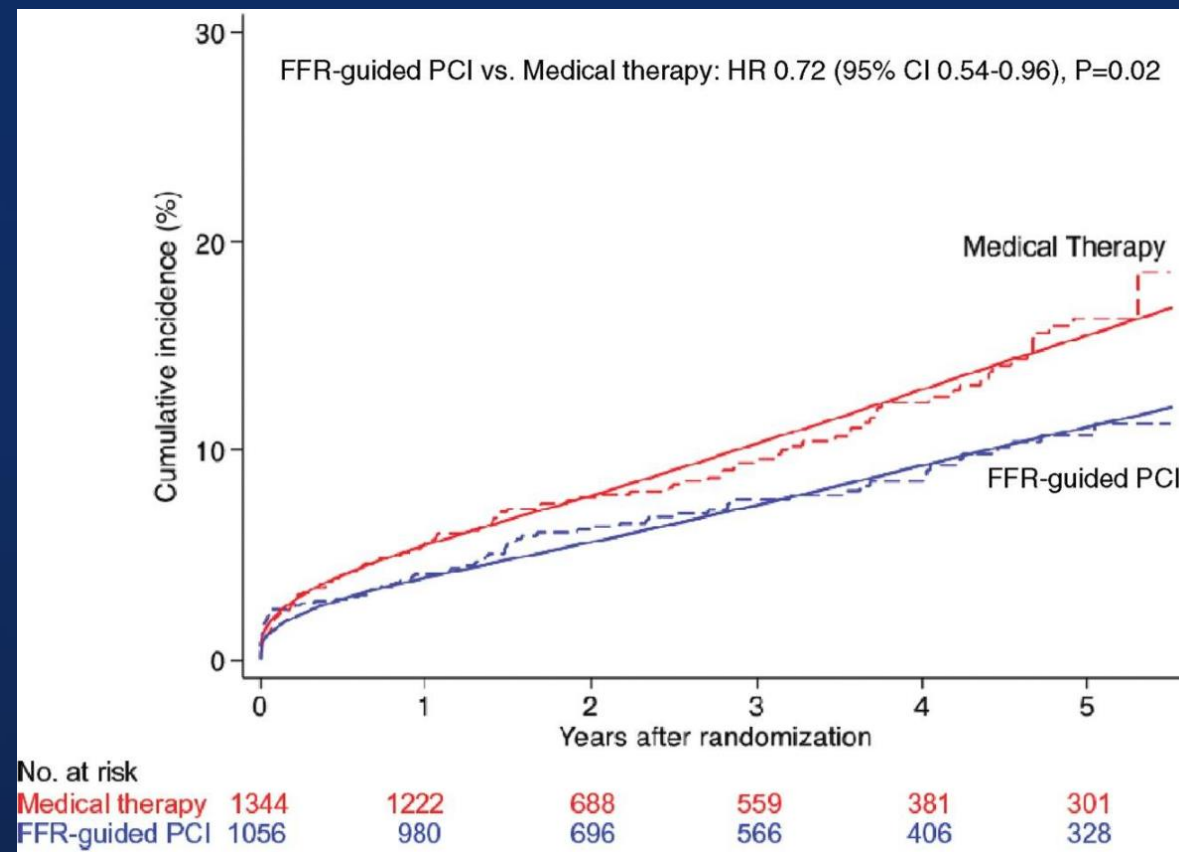

FFR-Guided Multivessel Angioplasty in Myocardial Infarction

COMPARE-ACUTE trial

- 885 patients with STEMI and multivessel
- underwent primary PCI
- Randomization(1:2)

Complete revascularization of non-infarct-related coronary arteries guided by FFR
(295 patients)

VS

No revascularization of non-infarct-related coronary arteries (590 patients)

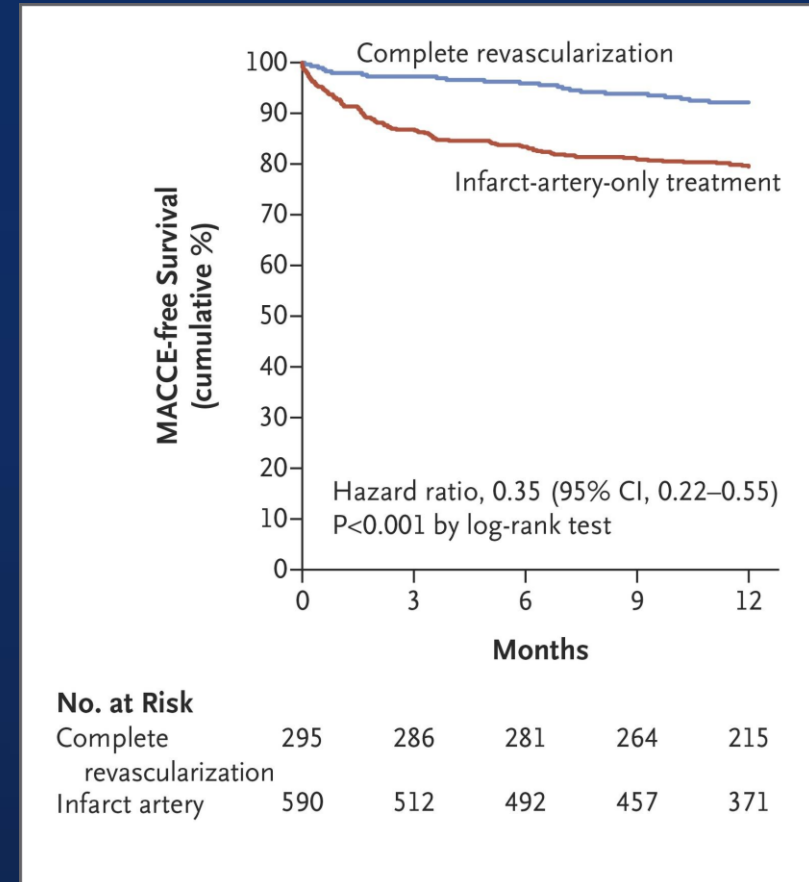

FFR-Guided Multivessel Angioplasty in STEMI

Complete revascularization by FFR vs culprit only revascularization

All cause mortality
HR 1.24 [0.65-2.35]

Non-fatal MI
HR 0.96 [0.60-1.56]

Repeat revascularization
HR 0.36 [0.26-0.51]

MACE
HR 0.47 [0.35-0.62]

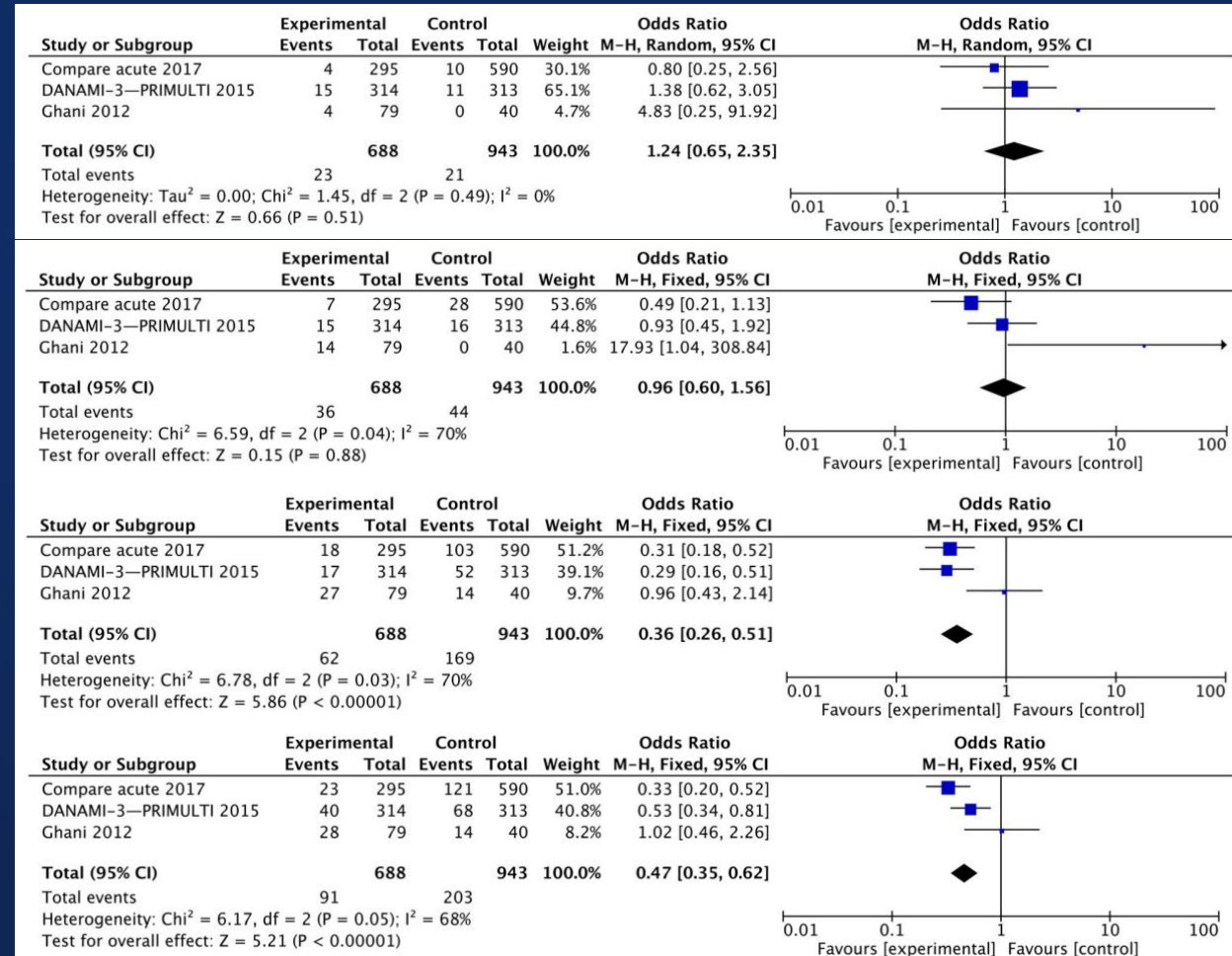

Pitfalls with Pressure Measurement

- **Introducer needle**
- **Height of the fluid-filled transducer**
- **Equalization**
- **Hyperemia**
- **Drift**
- **Guiding catheter wedging**
- **Side holes**
- **Whipping**
- **Accordion effect**

Instantaneous wave-Free Ratio (iFR)

$$\Delta P = \Delta Q \times R \longrightarrow \Delta P \approx \Delta Q \times R$$

Changes in pressure across a stenosis
under constant and minimized coronary resistance can
be a **surrogate for blood flow to myocardium.**

For minimizing intracoronary resistance during measurement

- FFR : adenosine infusion, average over several cycles
- iFR : **wave free period**, instantaneous pressure

Instantaneous wave-Free Ratio (iFR)

- Wave free period ; resistance naturally constant and minimized in the cardiac cycle

$$iFR = \frac{Pd_{\text{wave free period}}}{Pa_{\text{wave free period}}}$$

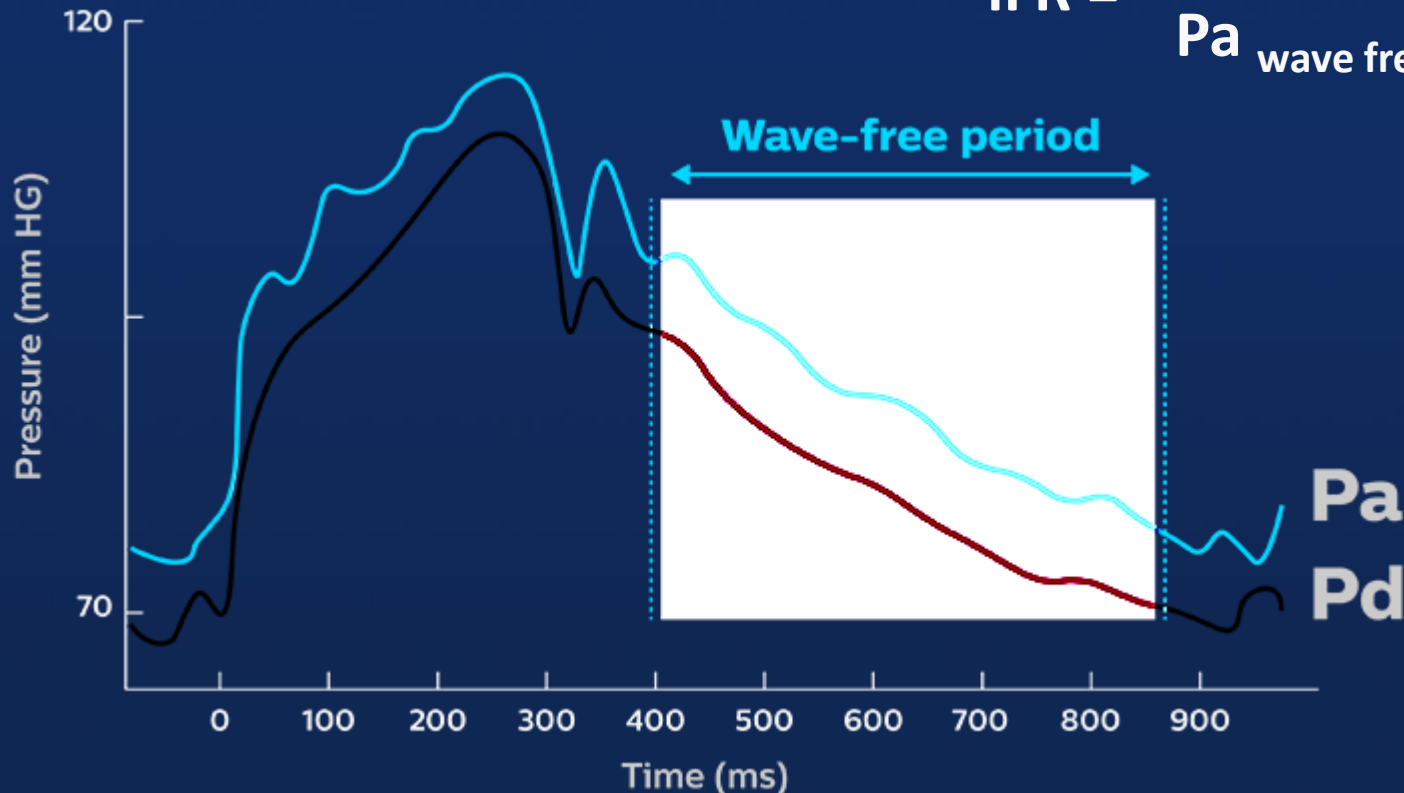

iFR vs FFR to Guide PCI

iFR-SWEDEHEART trial

- 2037 participants with stable angina or an acute coronary syndrome
- Underwent coronary revascularization
- Randomization (1:1)
- a multicenter, controlled, open-label clinical trial

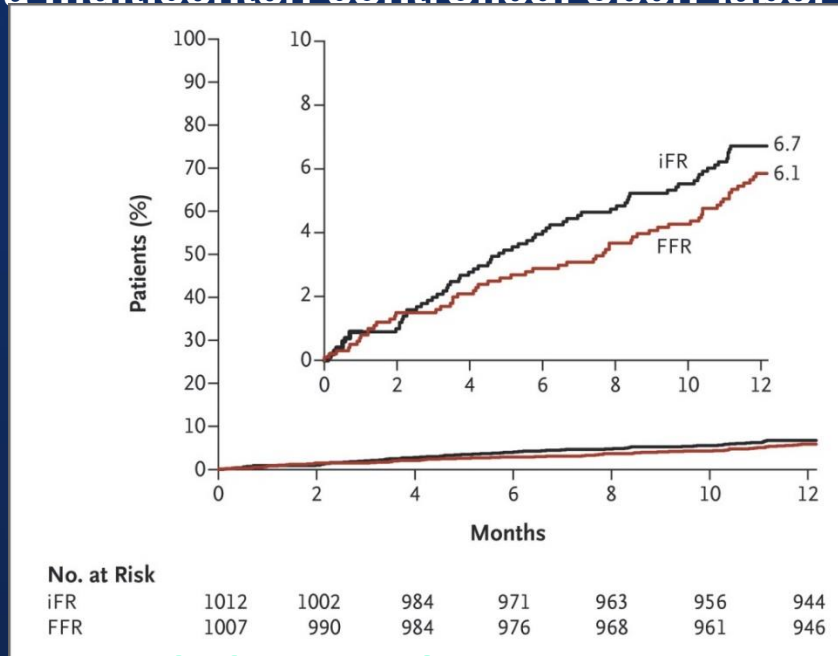

iFR-guided
VS
FFR-guided

An iFR-guided revascularization strategy was noninferior to an FFR-guided revascularization strategy with respect to the rate of MACE(1yr)

Göteborg M et al. *N Engl J Med* 2017. DOI: 10.1056/NEJMoa1616540

Use of the Instantaneous Wave-free Ratio

DEFINE-FLAIR trial

- 2492 patients with coronary artery disease
- Underwent coronary revascularization
- Randomization (1:1)
- a multicenter, international, blinded trial

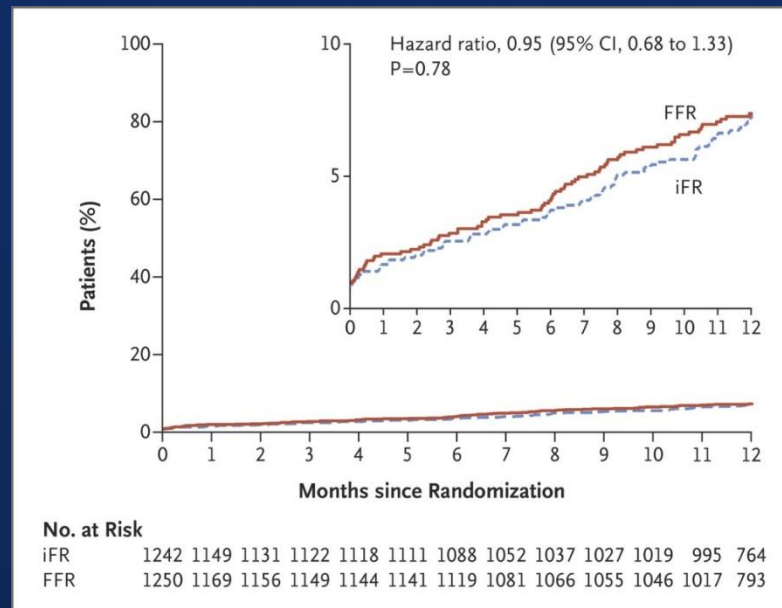

iFR-guided
VS
FFR-guided

Coronary revascularization guided by iFR was noninferior to revascularization guided by FFR with respect to the risk of MACE(1yr)

Davies JE et al. N Engl J Med 2017. DOI: 10.1056/NEJMoa1700445

iFR vs FFR in LAD lesions

DEFINE-FLAIR trial sub-study

LAD lesion

Non-LAD lesion

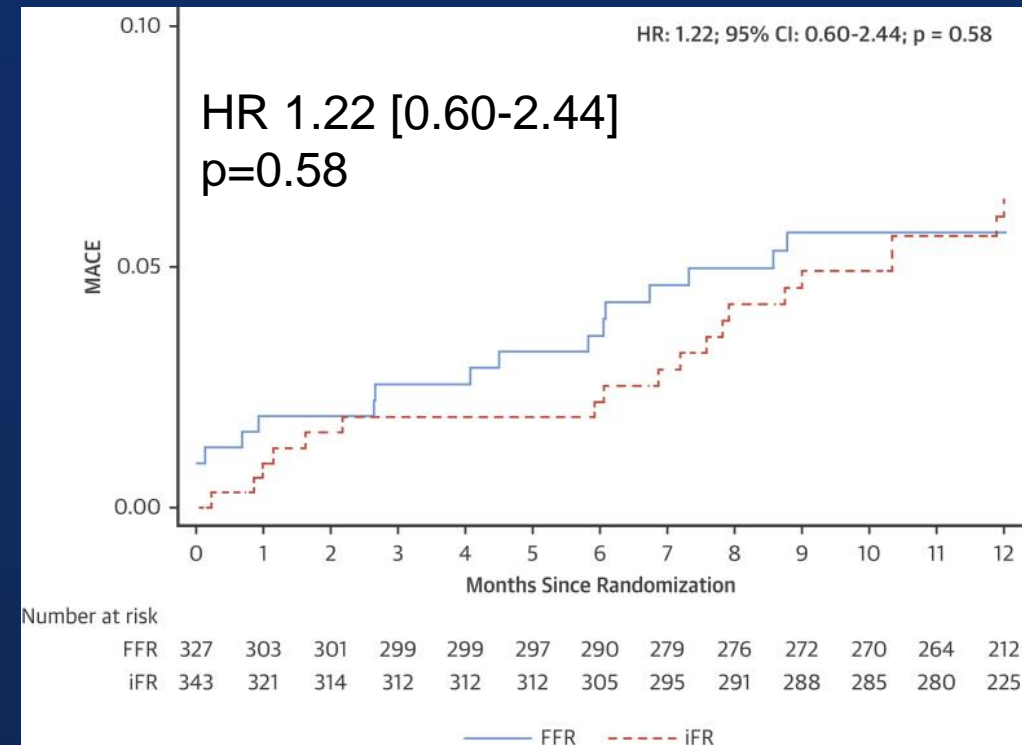
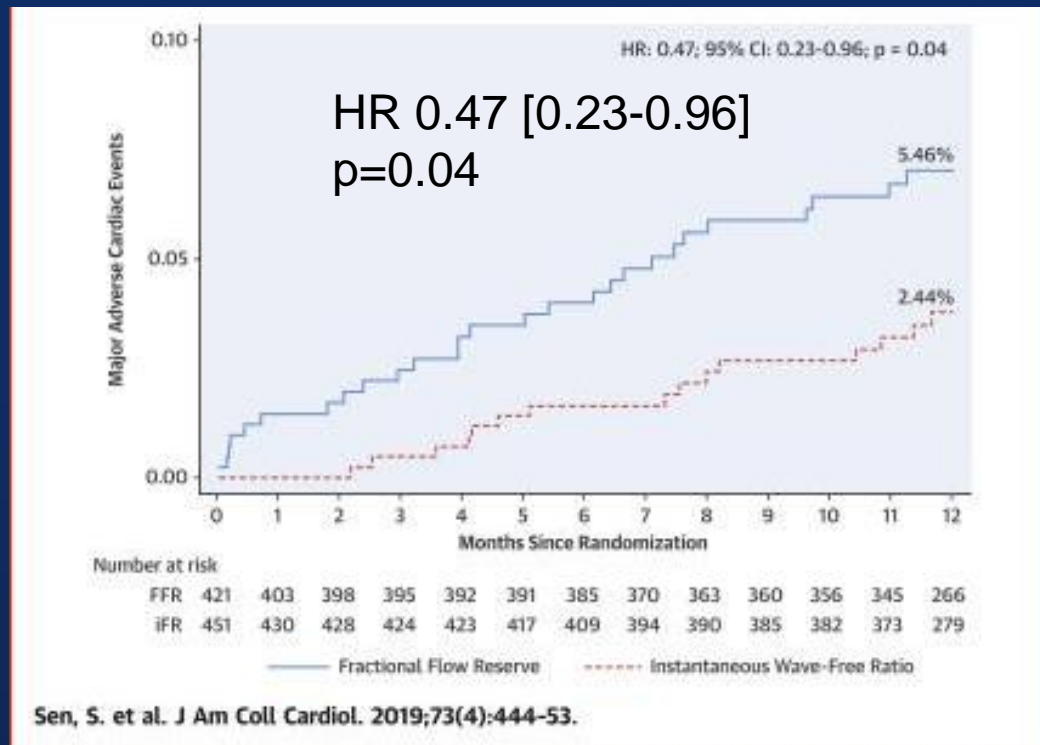

iFR vs FFR to Guide PCI

META-ANALYSIS OF ANGIOGRAPHY, IFR AND FFR GUIDED PCI

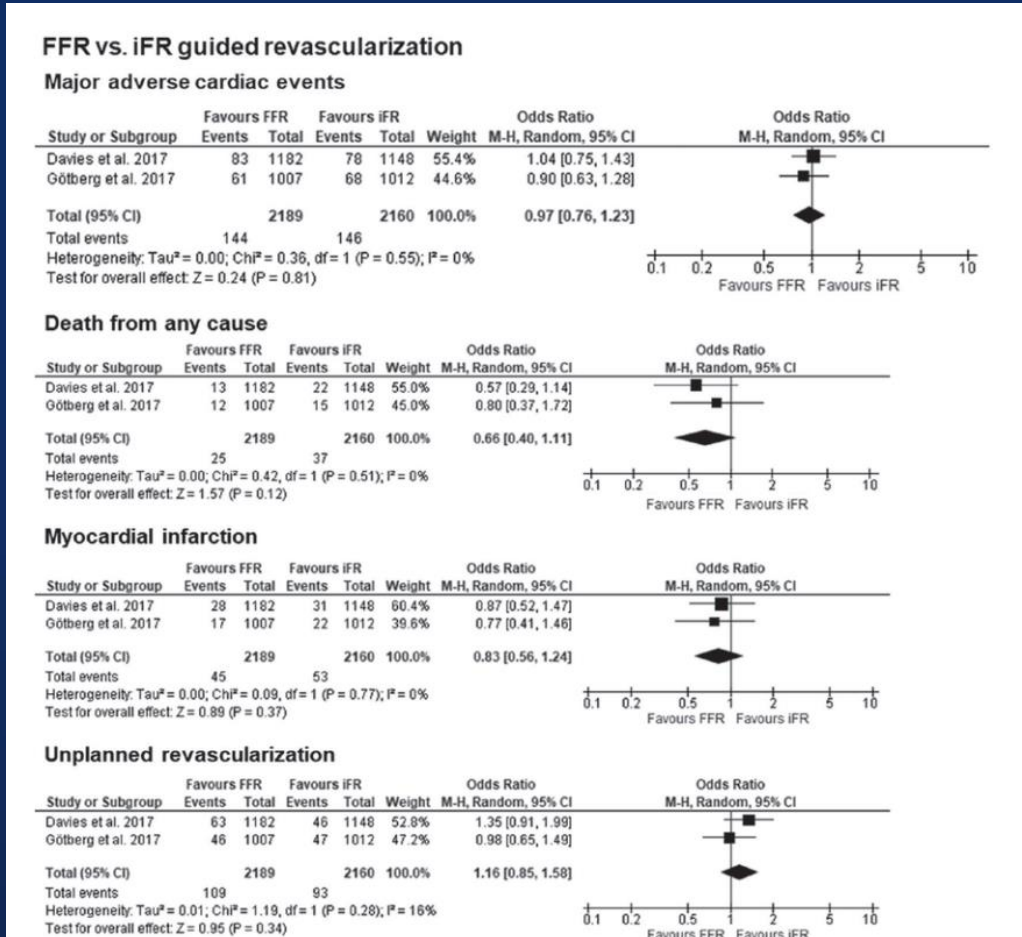

iFR-SWEDHEART study
DEFINE-FLAIR study

significant lower numbers in chest discomfort (P<0.001) when using iFR

There is no significant superiority of FFR over iFR

Baumann et al. *Exp Ther Med.* 2019 Mar;17(3):1939-1951. doi: 10.3892/etm.2019.7156. Epub 2019 Jan 7.

iFR vs FFR concordance

3V FFR-FRIENDS substudy

- Comparison of 2-Year Clinical Outcomes of Lesions Classified by FFR and iFR in Deferred Lesions
- 821 deferred lesion (n=374)
- Primary outcome : MACE at 2 years
- Group 1 : FFR > 0.80 and iFR > 0.89
- Group 2 : FFR > 0.80 and iFR ≤ 0.89
- Group 3 : FFR ≤ 0.80 and iFR > 0.89
- Group 4 : FFR ≤ 0.80 and iFR ≤ 0.89

The discordant results between FFR and iFR were not associated with the increased risk of MACE. The risk of MACE was significantly increased only in lesions with abnormal results of both FFR and iFR.

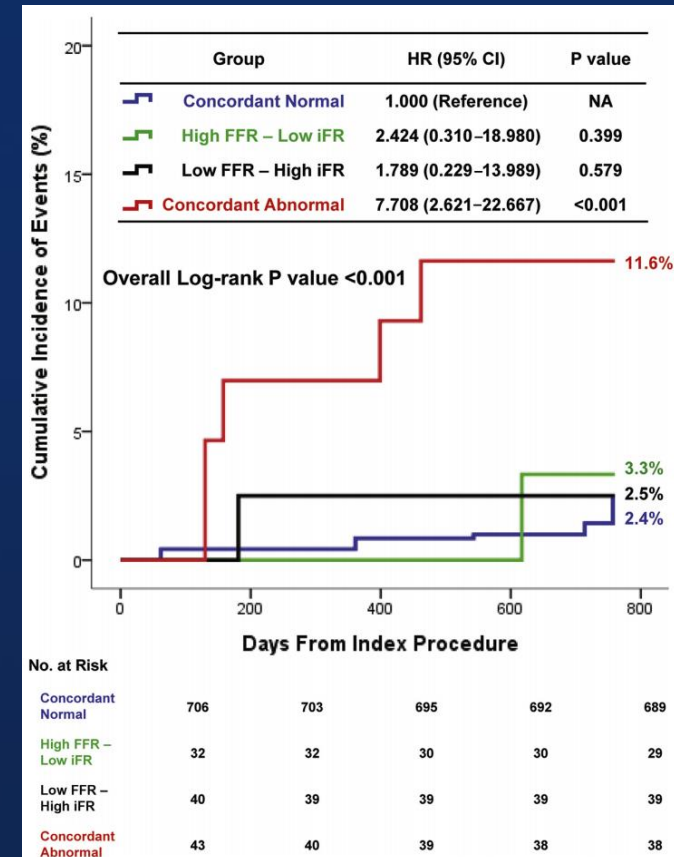

FAVOR III China

QFR-guided PCI versus Angiography-guided PCI

Death/MI or Ischemic Driven Revascularization

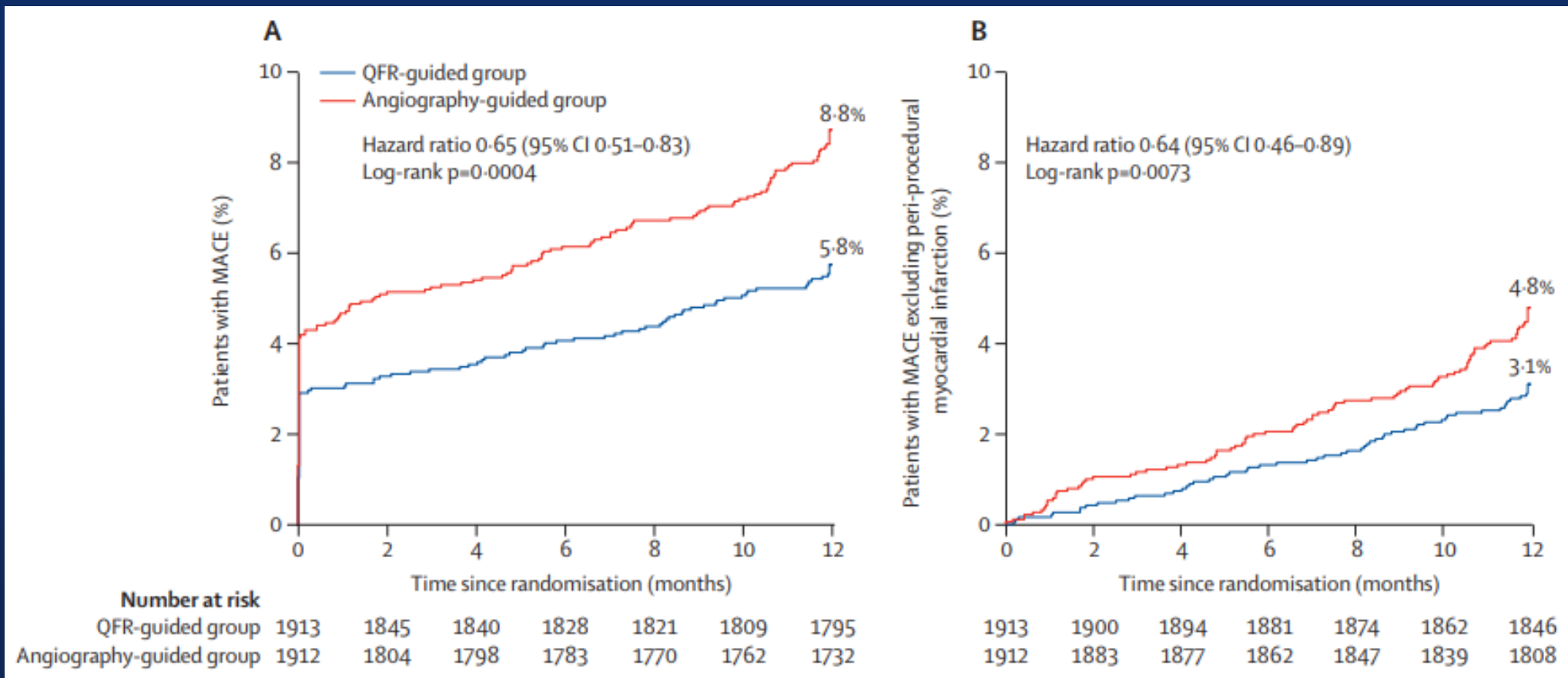

FLOWER MI

In Patients with STEMI
Undergoing Complete Revascularization
(n=1171)



Primary Endpoint at 1 year:
Death from any cause, nonfatal myocardial infarction or
unplanned hospitalization leading to urgent
revascularization

FLOWER MI

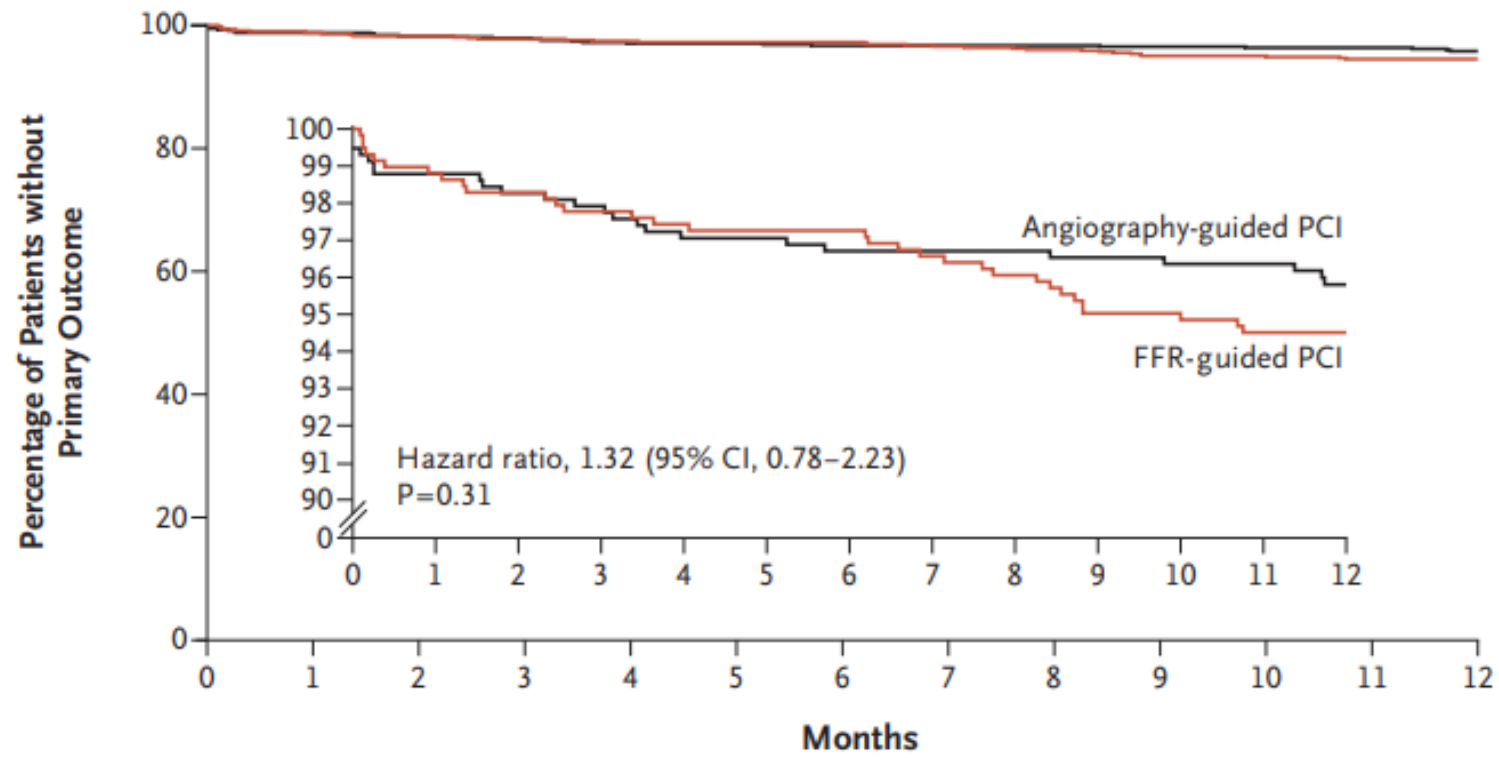

No. at Risk		0	1	2	3	4	5	6	7	8	9	10	11	12
Angiography-guided PCI	577	570	567	565	560	560	557	555	555	554	552	548	371	
FFR-guided PCI	586	577	573	570	567	566	566	562	559	553	553	549	385	

FUTURE

Multivessel CAD Patients at Angiography
3 stenosis > 50% per patient
(n=927)

R

```
graph TD; R((R)) --> A[Angiography Evaluation only (>50% Stenosis) (n=467)]; R --> B[FFR in all target lesions 43% (FFR > 0.80) (n=460)];
```

Angiography Evaluation only
(>50% Stenosis)
(n=467)

FFR in all target lesions
43% (FFR > 0.80)
(n=460)

Primary Endpoint at 1 year:
Death from any cause, nonfatal myocardial infarction,
Stroke, or unplanned revascularization

FUTURE

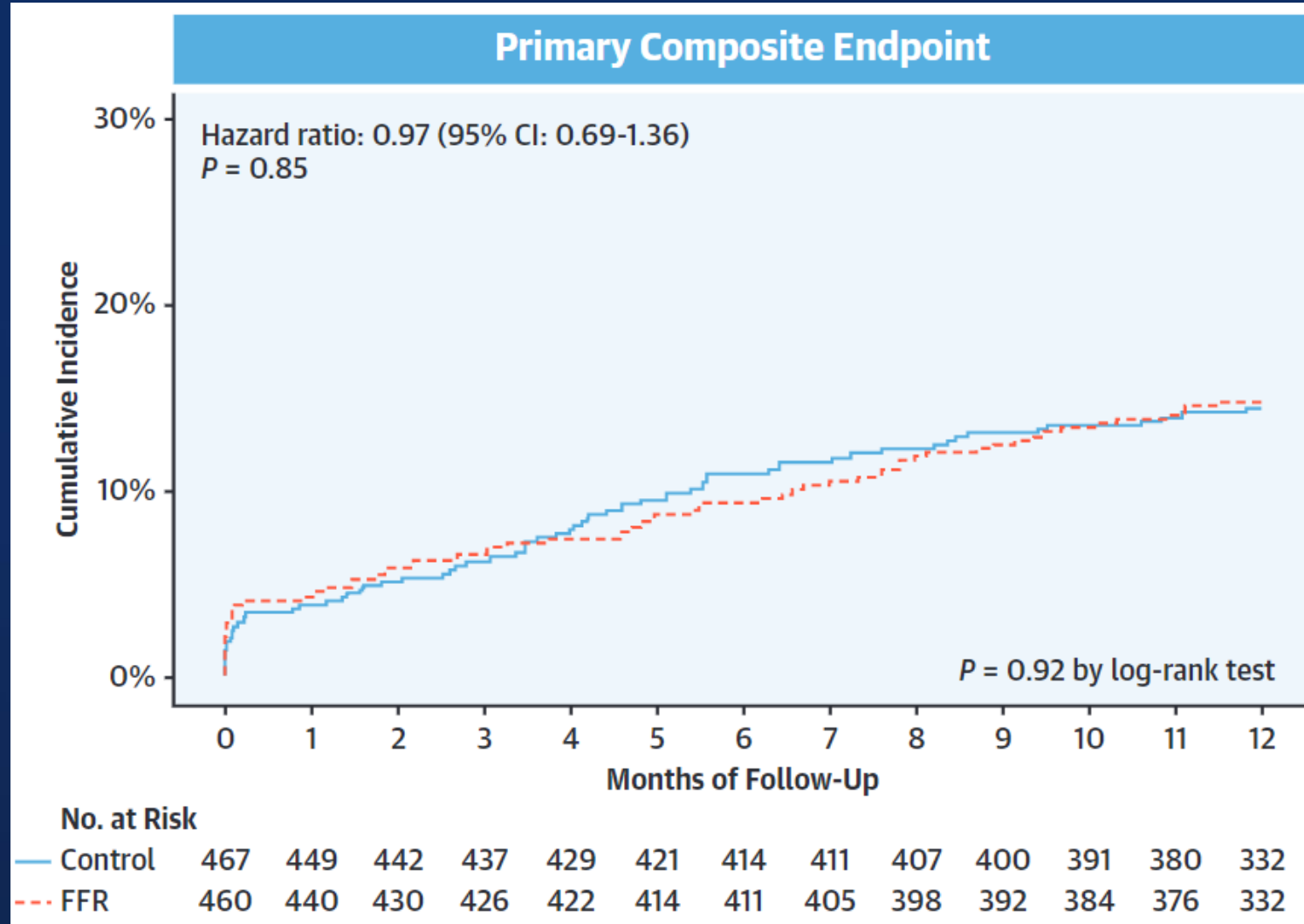

FLAVOUR trial

Patients with de novo intermediate stenosis
(40–70%) eligible for PCI
(n=1682)

R

```
graph TD; R((R)) --> FFR[FFR guided PCI  
(n=838)]; R --> IVUS[IVUS-guided PCI  
(n=844)];
```

FFR guided PCI
(n=838)

IVUS-guided PCI
(n=844)

Primary Endpoint at 2 year:
Death from any cause, myocardial infarction,
and any revascularization

FLAVOUR trial

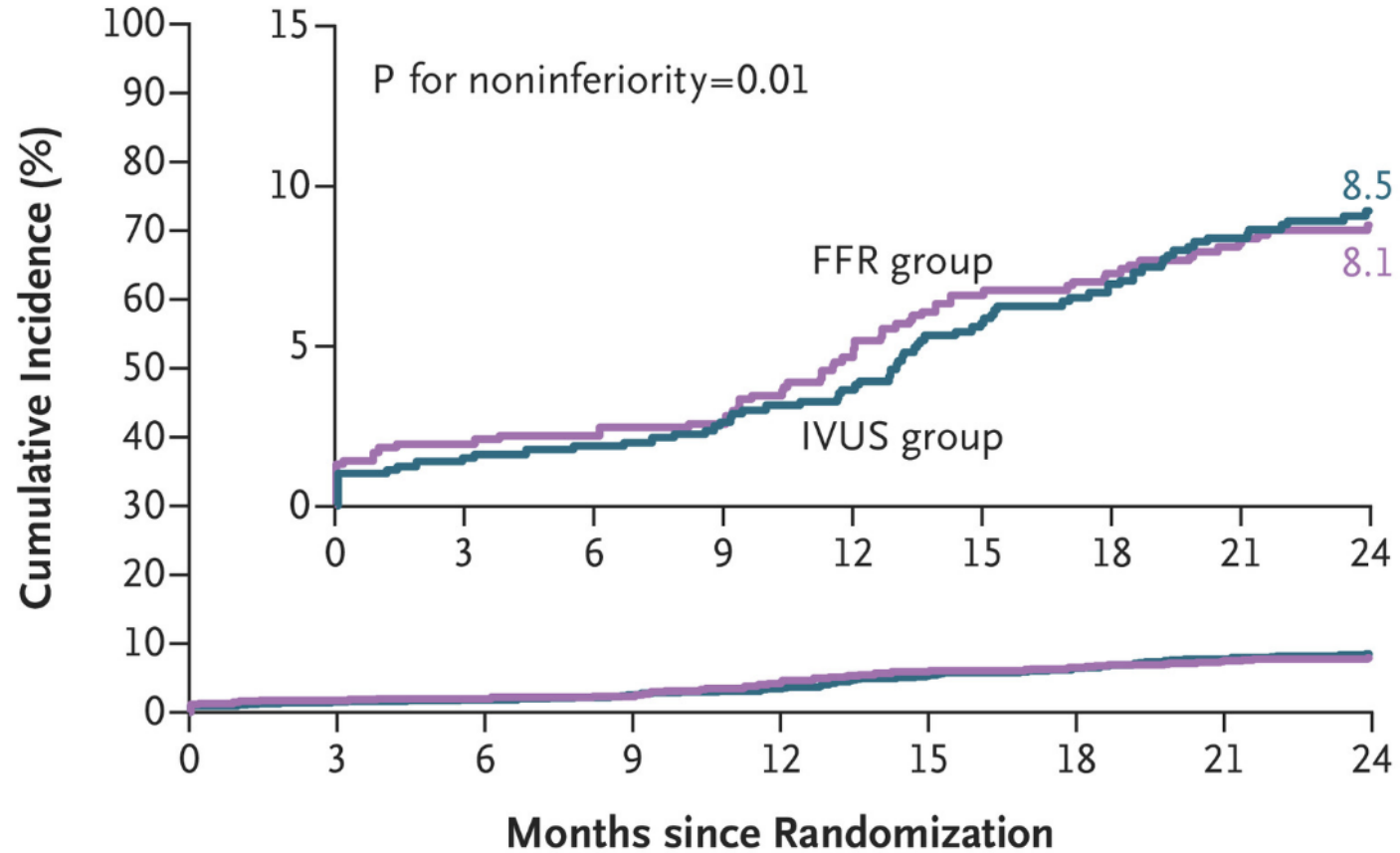

No. at Risk

IVUS group	844	828	825	820	809	792	784	771	690
FFR group	838	818	816	812	796	781	778	770	699

COMPLETE trial

4041 STEMI patients with non-culprit stenosis (visual > 70% or FFR < 0.80) were randomized into complete revascularization (N=2016) versus culprit-only PCI (N=2025) groups

Primary endpoint: cardiac death or new MI

Co-Primary endpoint: cardiac death or new MI, ischemia-driven revascularization

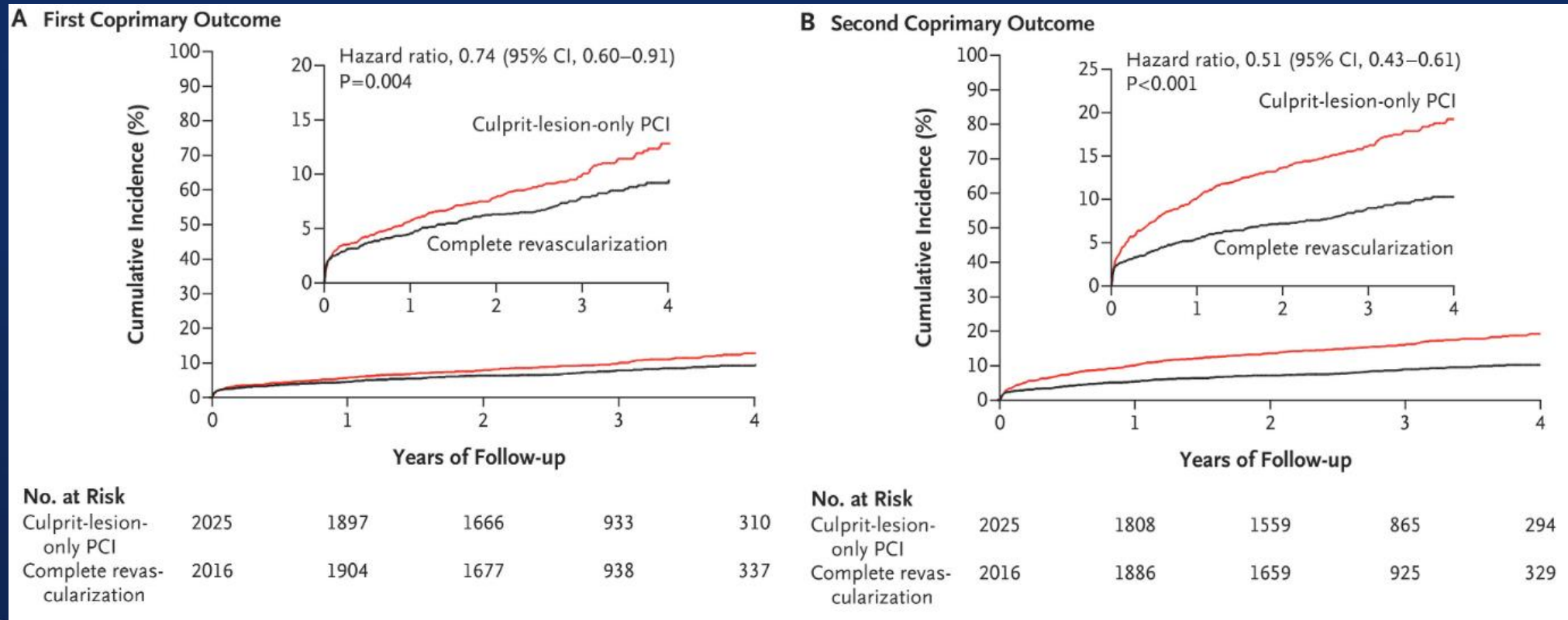

Gray-zone FFR

Data from IRIS-FFR Registry

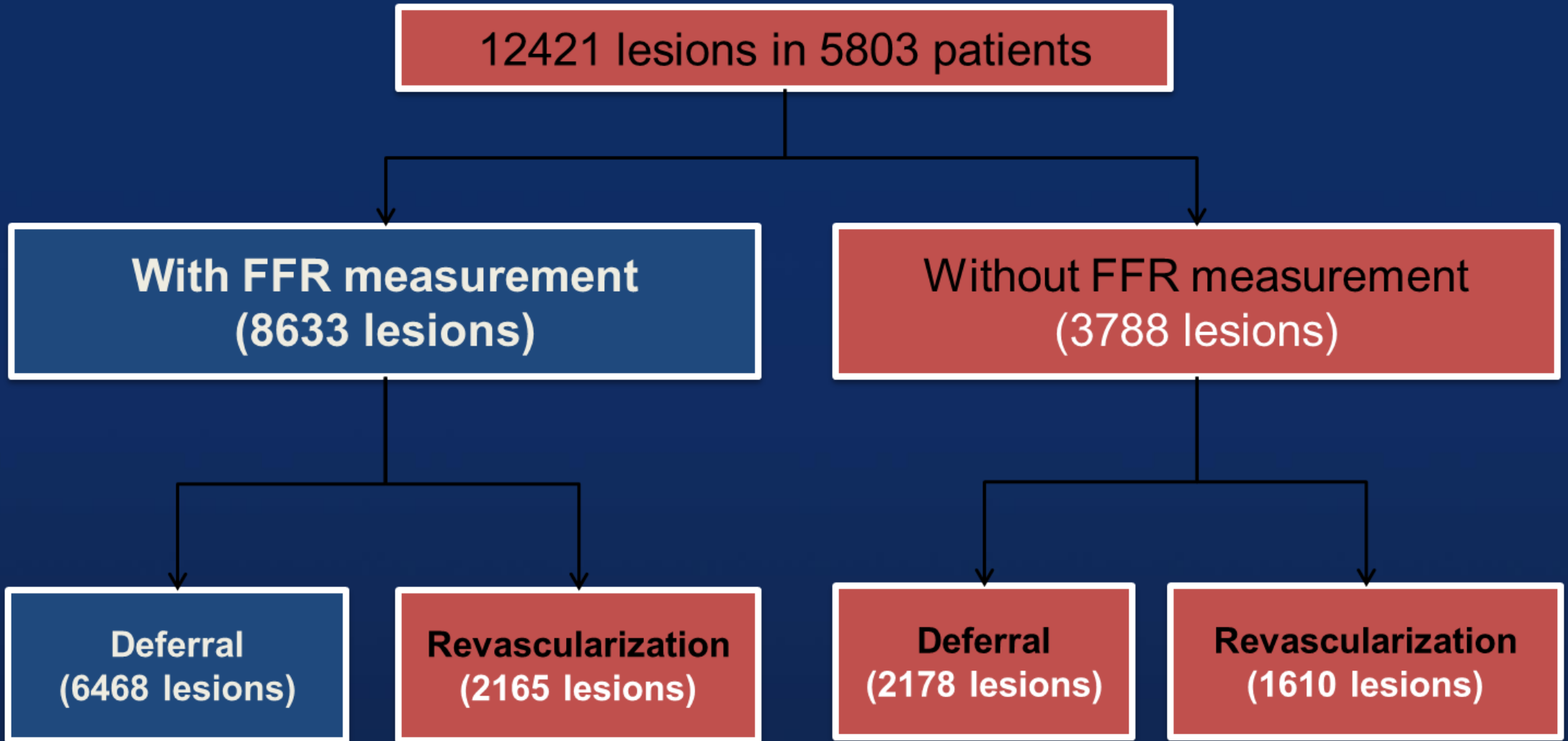

Data from IRIS-FFR Registry

ORIGINAL RESEARCH ARTICLE



Fractional Flow Reserve and Cardiac Events in Coronary Artery Disease

Data From a Prospective IRIS-FFR Registry (Interventional Cardiology Research Incooperation Society Fractional Flow Reserve)

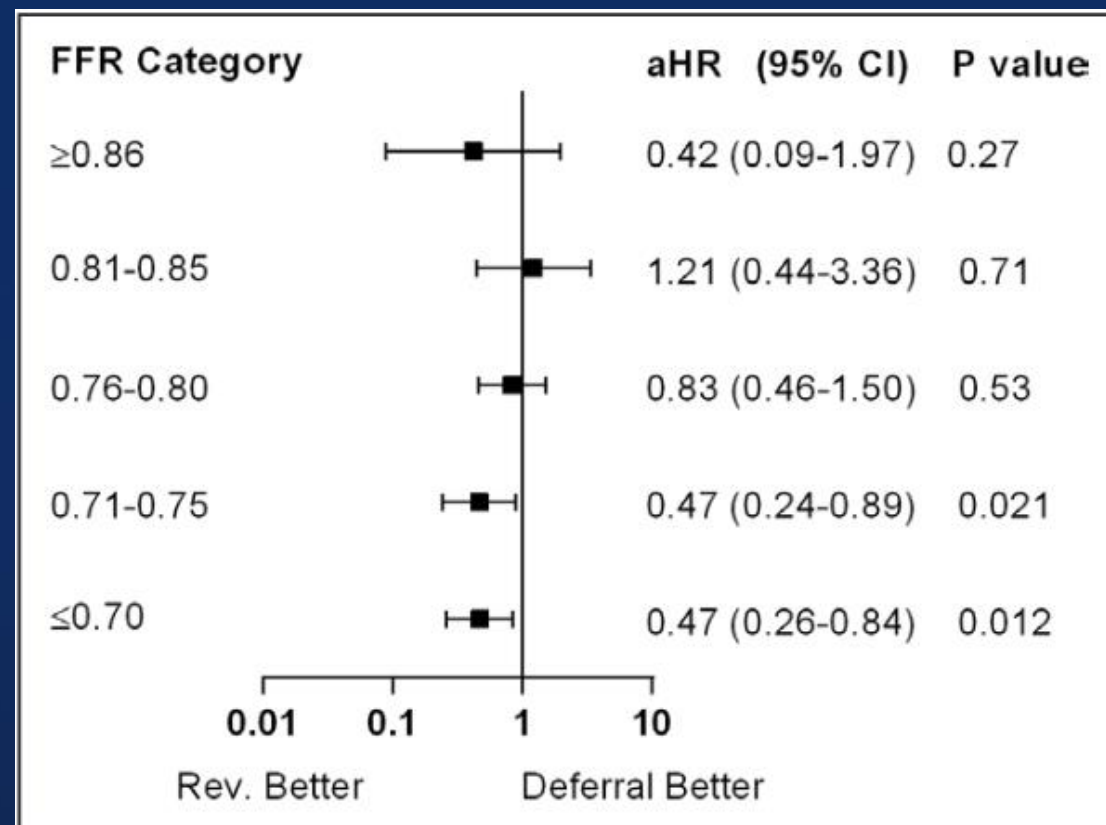
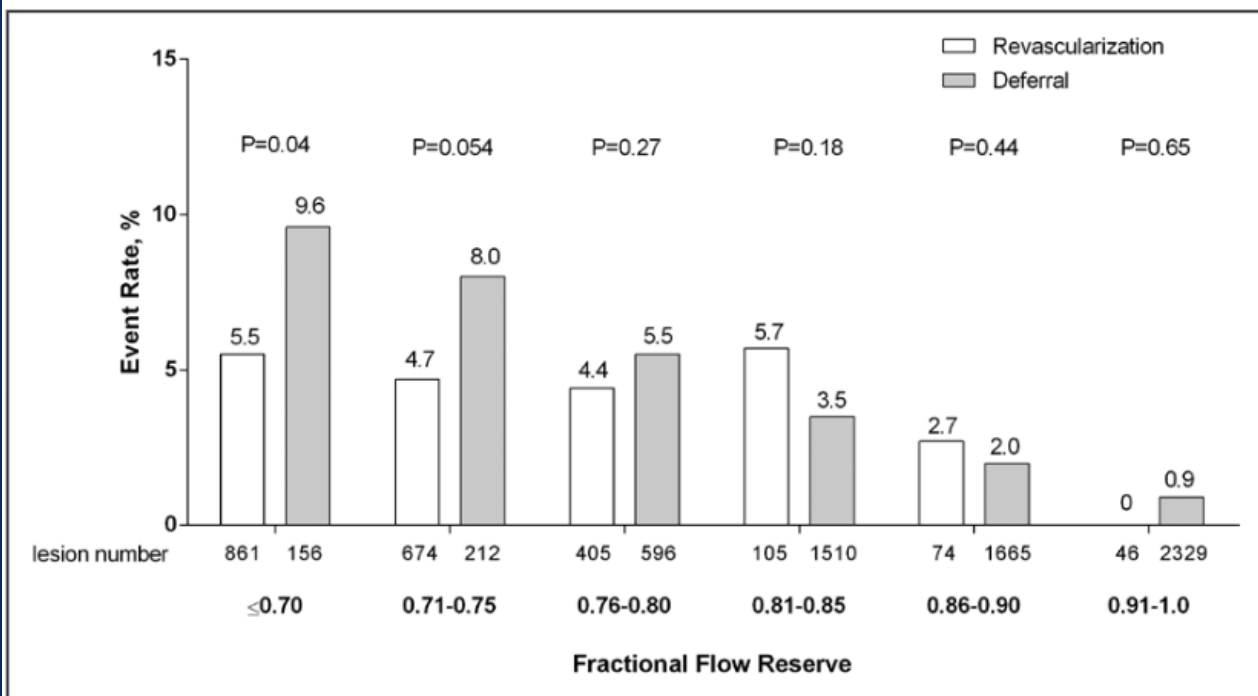

Defer vs. PCI in Gray-zone FFR



ESC

European Society
of Cardiology

European Heart Journal (2018) **0**, 1–10

doi:10.1093/eurheartj/ehy079

CLINICAL RESEARCH

Interventional cardiology

Deferred vs. performed revascularization for coronary stenosis with grey-zone fractional flow reserve values: data from the IRIS-FFR registry

Do-Yoon Kang[†], Jung-Min Ahn[†], Cheol Hyun Lee, Pil Hyung Lee, Duk-Woo Park, Soo-Jin Kang, Seung-Whan Lee, Young-Hak Kim, Cheol Whan Lee, Seong-Wook Park, and Seung-Jung Park*

Heart Institute, University of Ulsan College of Medicine, Asan Medical Center, 388-1 Pungnap-dong, Songpa-gu, Seoul 138-736, South Korea

Primary End Point in Gray-zone FFR

(Death, TV-MI, Target Vessel Revascularization)

Overall Population

Matched Population

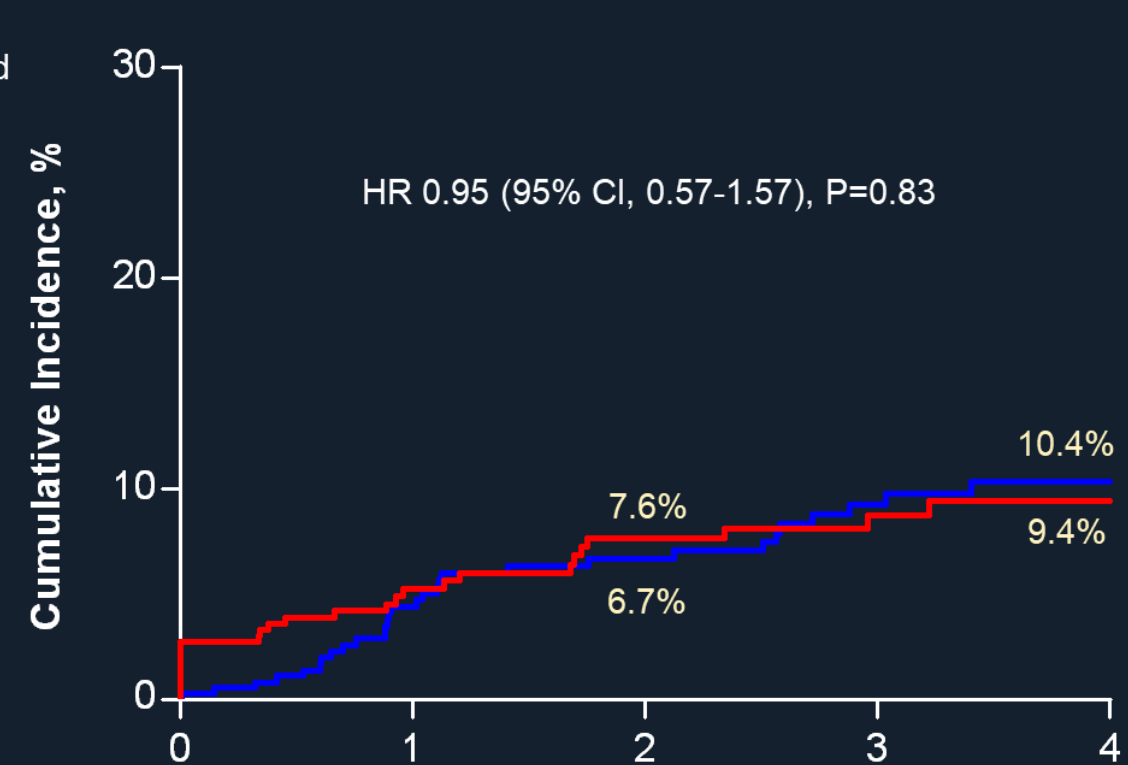
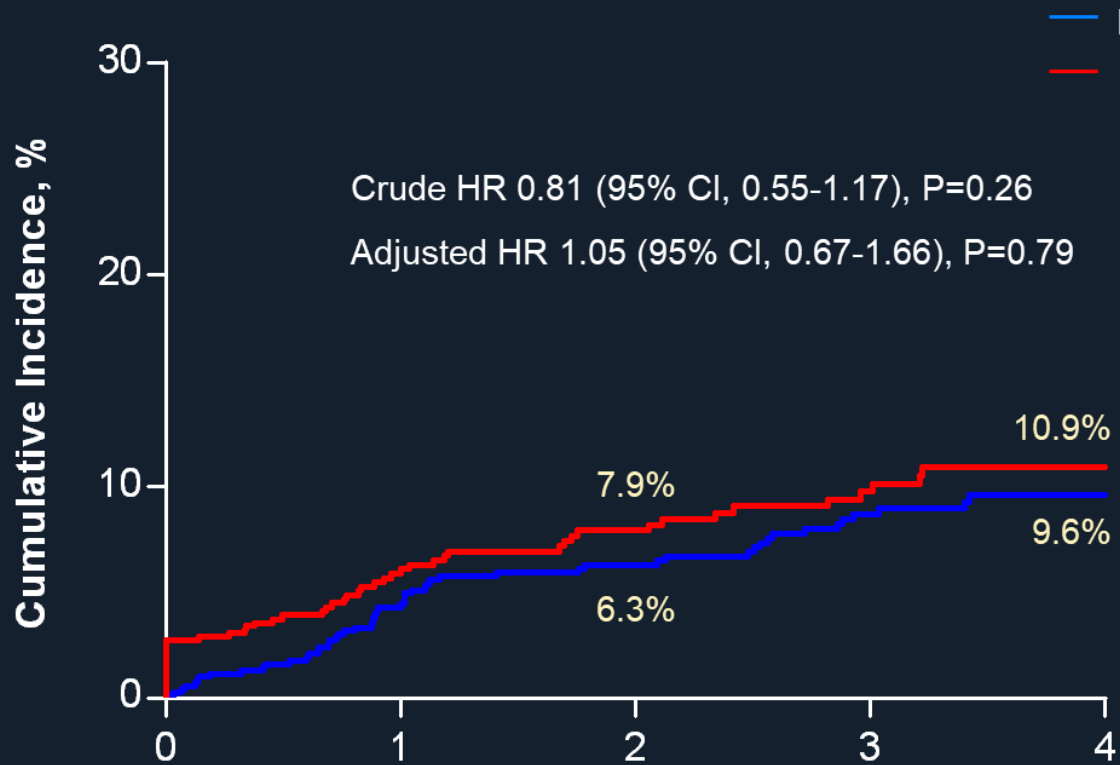

No. at Risk		Years				
	0	1	2	3	4	
Deferred	683	591	493	361	171	
Performed	651	449	343	247	144	

No. at Risk		Years				
	0	1	2	3	4	
Deferred	368	308	249	186	99	
Performed	368	263	204	144	84	

Death from any cause

Overall Population

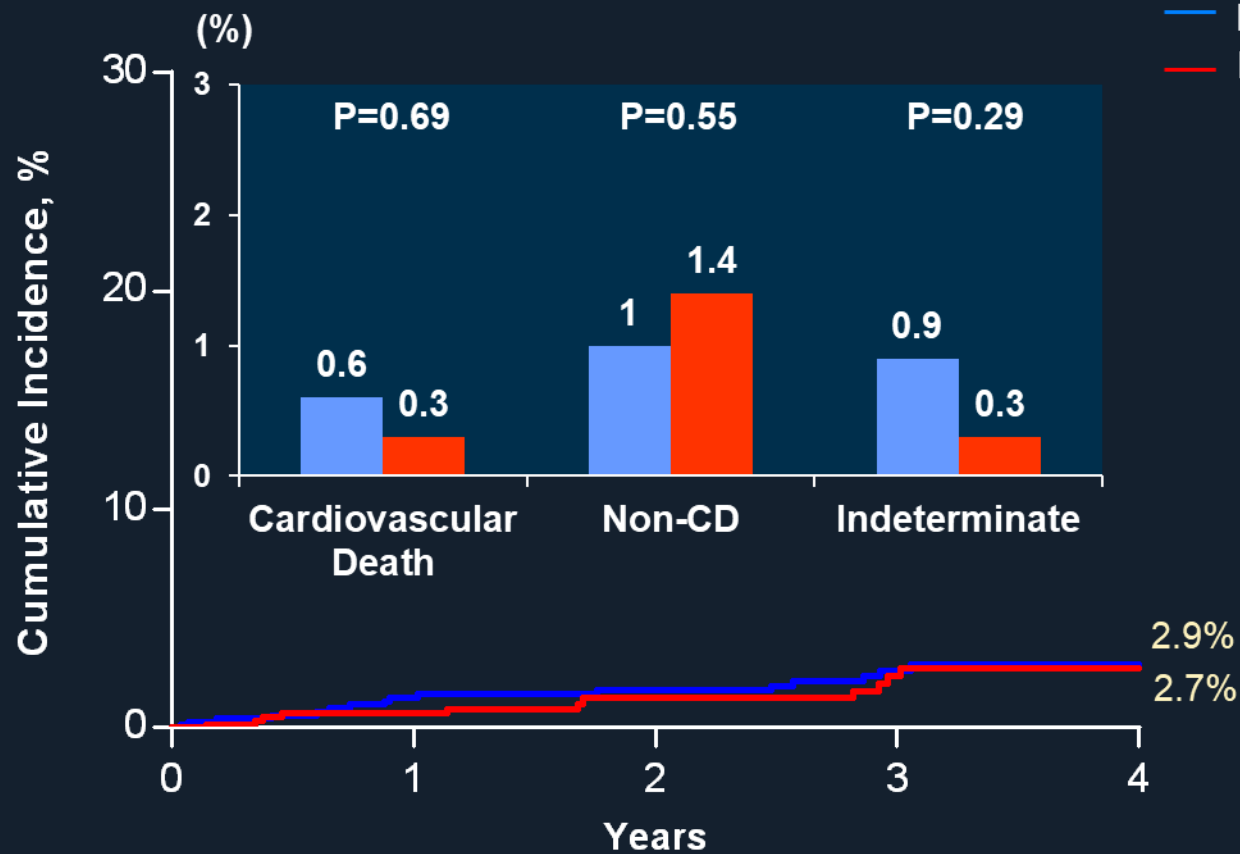

No. at Risk	0	1	2	3	4
Deferred	683	609	517	387	189
Performed	651	476	373	271	162

Matched Population

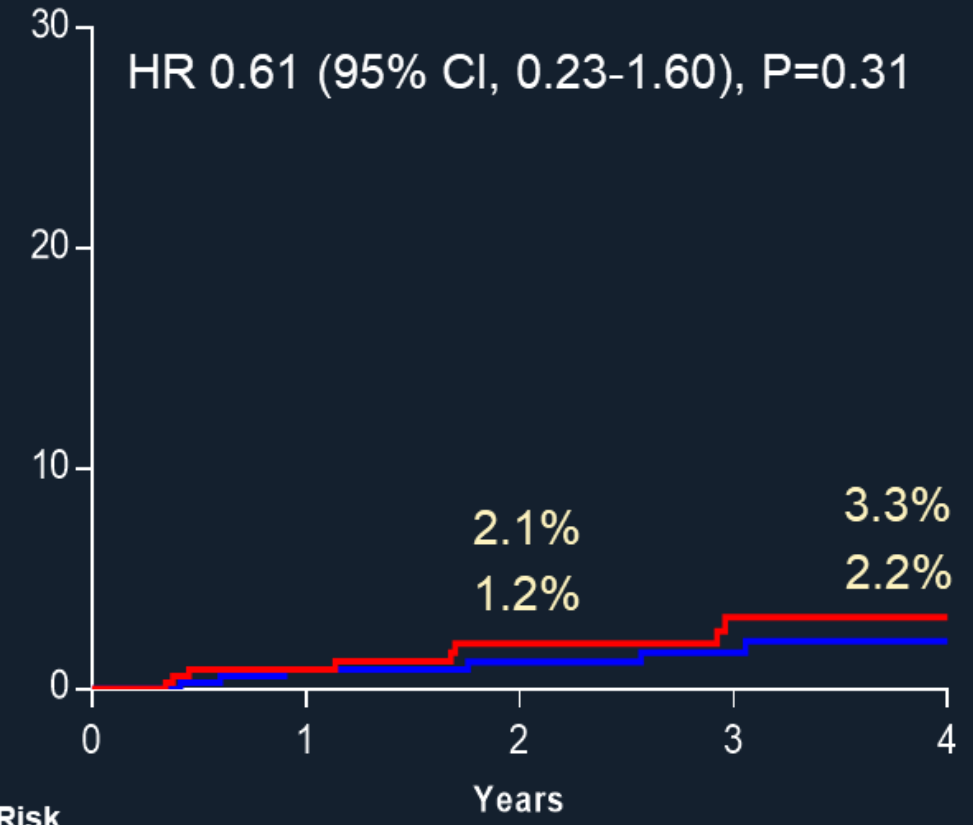

No. at Risk	0	1	2	3	4
Deferred	368	319	262	201	109
Performed	368	276	222	154	89

Myocardial Infarction

Overall Population

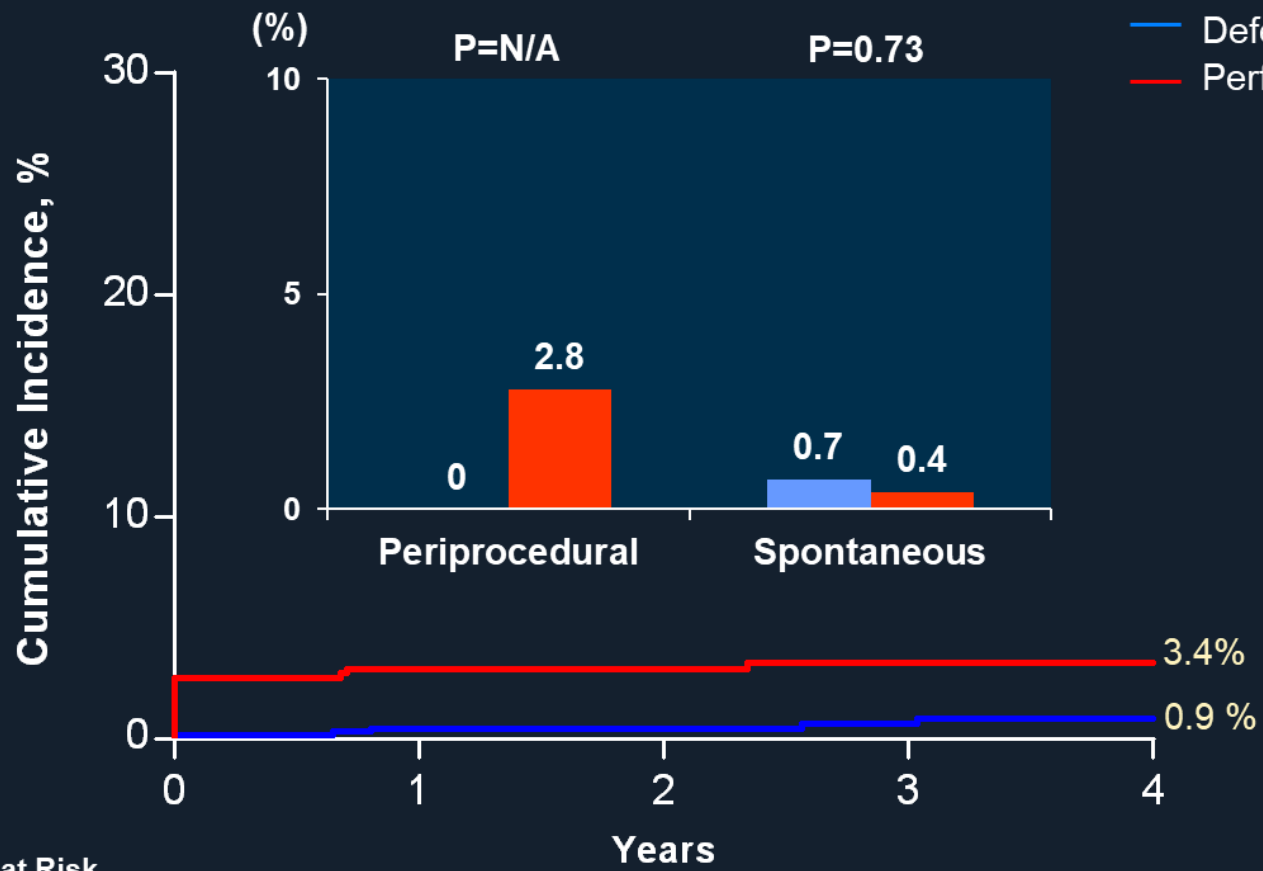

Matched Population

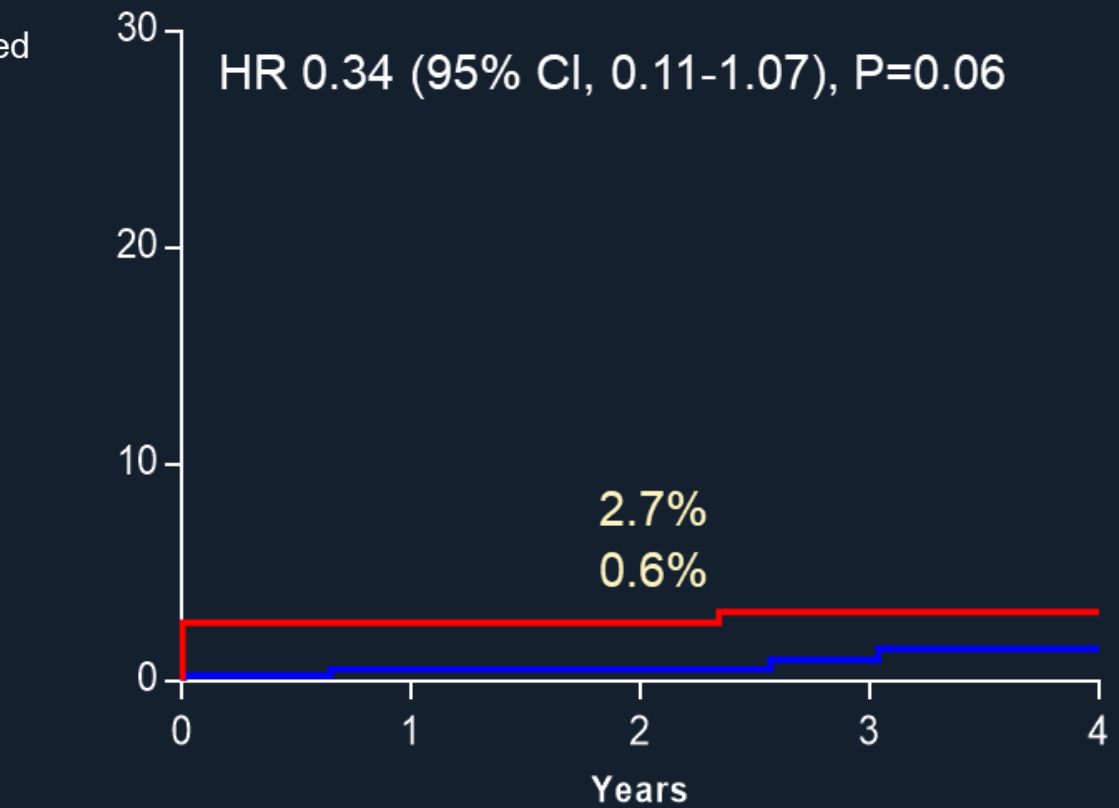

No. at Risk

	0	1	2	3	4
Deferred	683	606	514	387	188
Performed	651	452	353	261	156

No. at Risk

	0	1	2	3	4
Deferred	368	318	260	200	109
Performed	368	264	210	151	89

Death and Myocardial Infarction

Overall Population

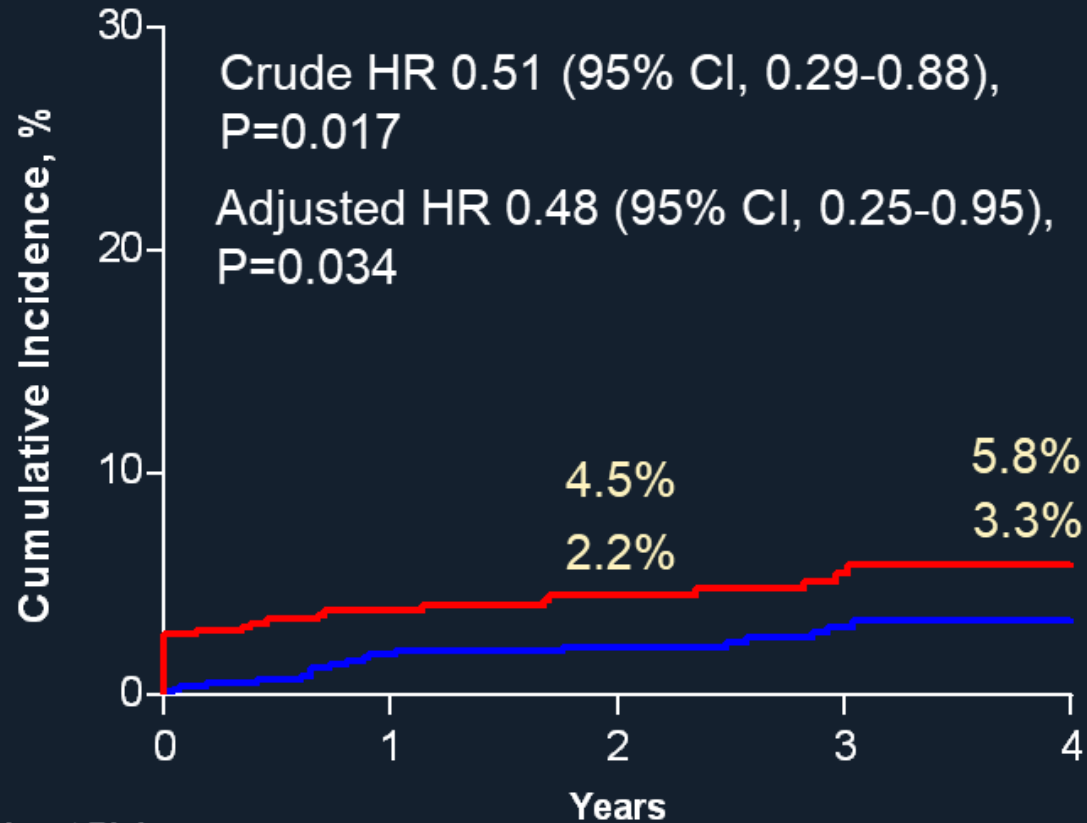

No. at Risk		Years				
Deferred	683	606	514	388	189	
Performed	651	460	358	260	154	

Matched Population

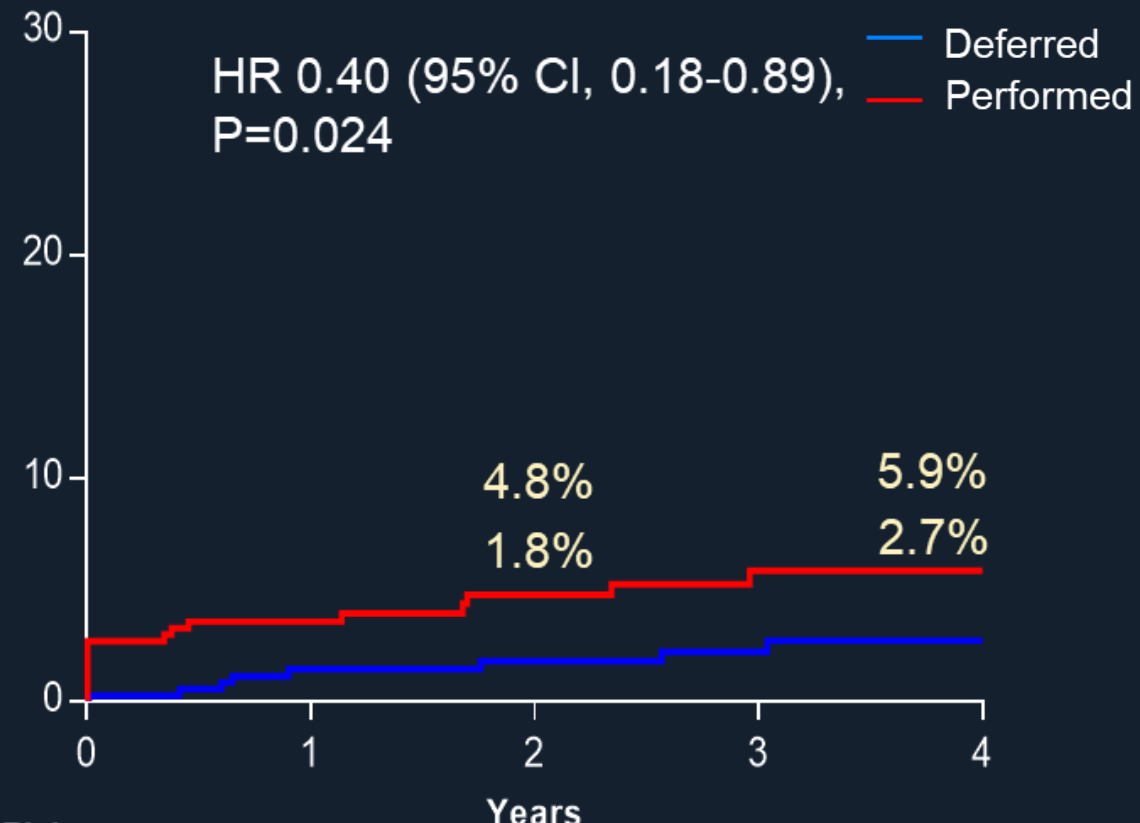

No. at Risk		Years				
Deferred	368	317	260	200	109	
Performed	368	268	212	150	87	

Death and Spontaneous MI

Overall Population

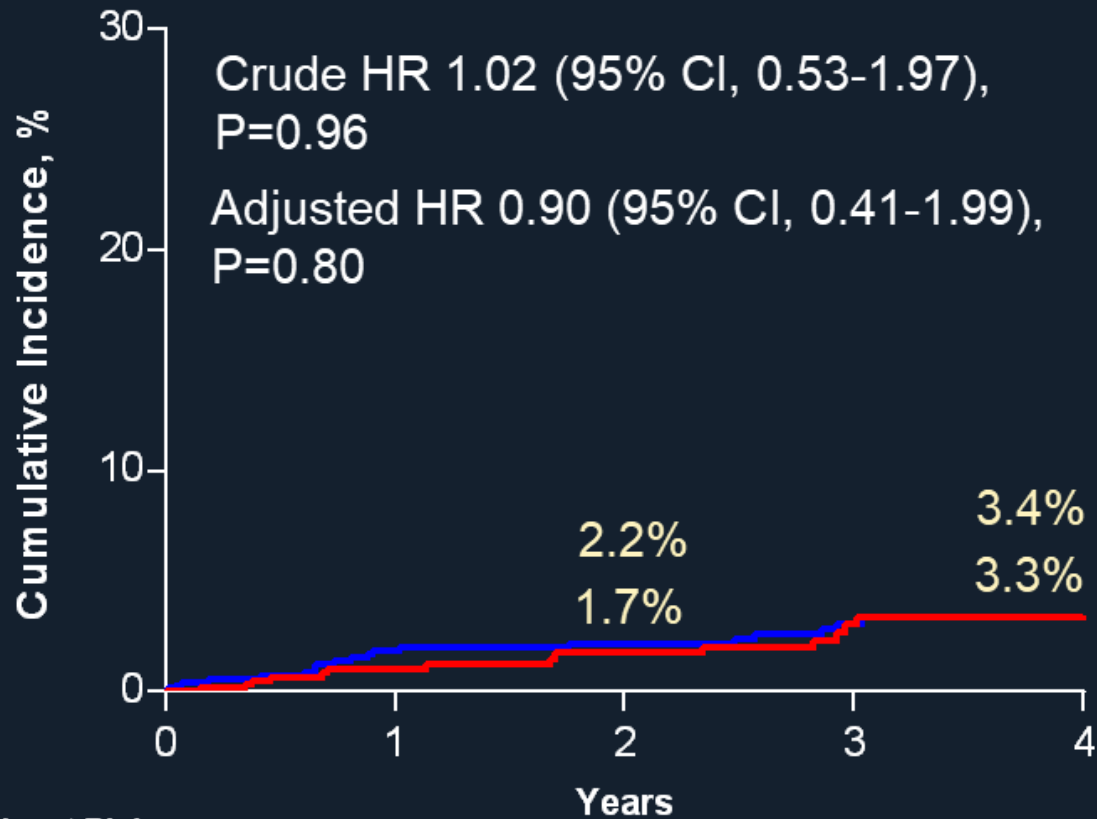

No. at Risk

Deferred	683	607	515	387	189
Performed	651	475	372	272	162

Matched Population

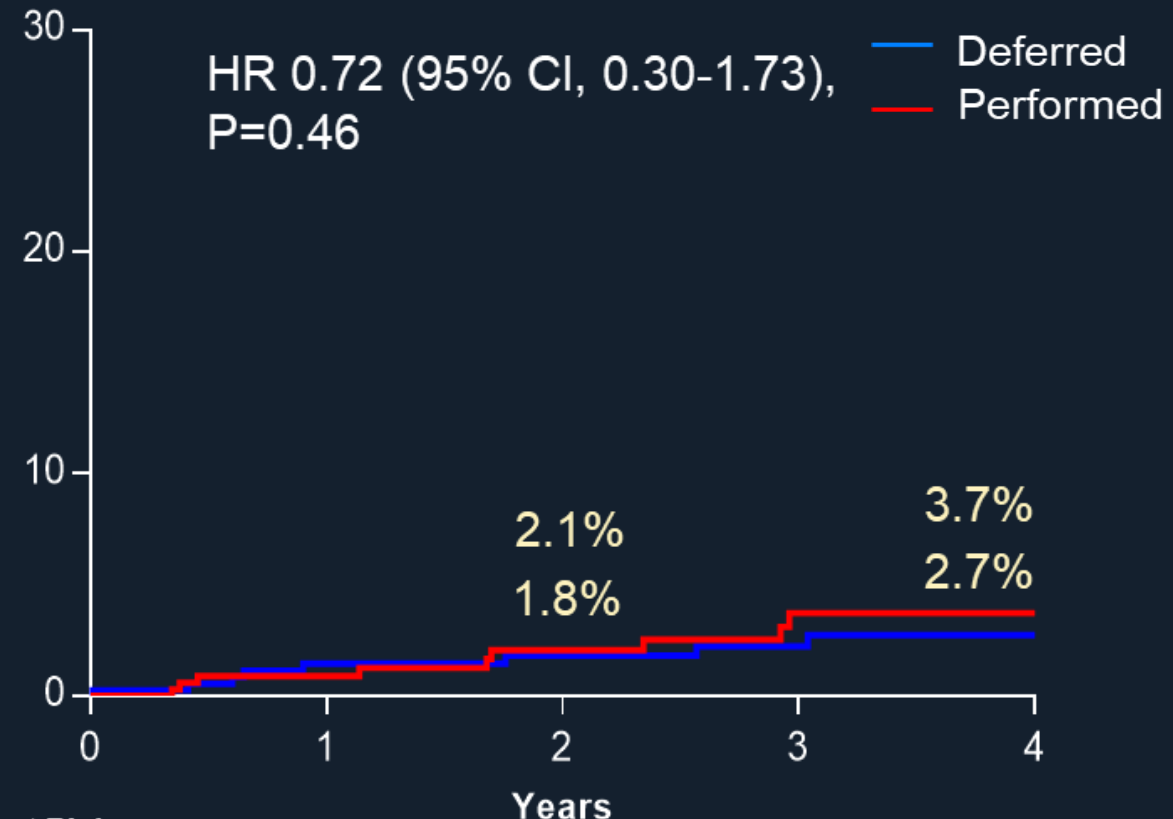

No. at Risk

Deferred	368	318	260	200	109
Performed	368	276	219	154	90

Target Vessel Revascularization

Overall Population

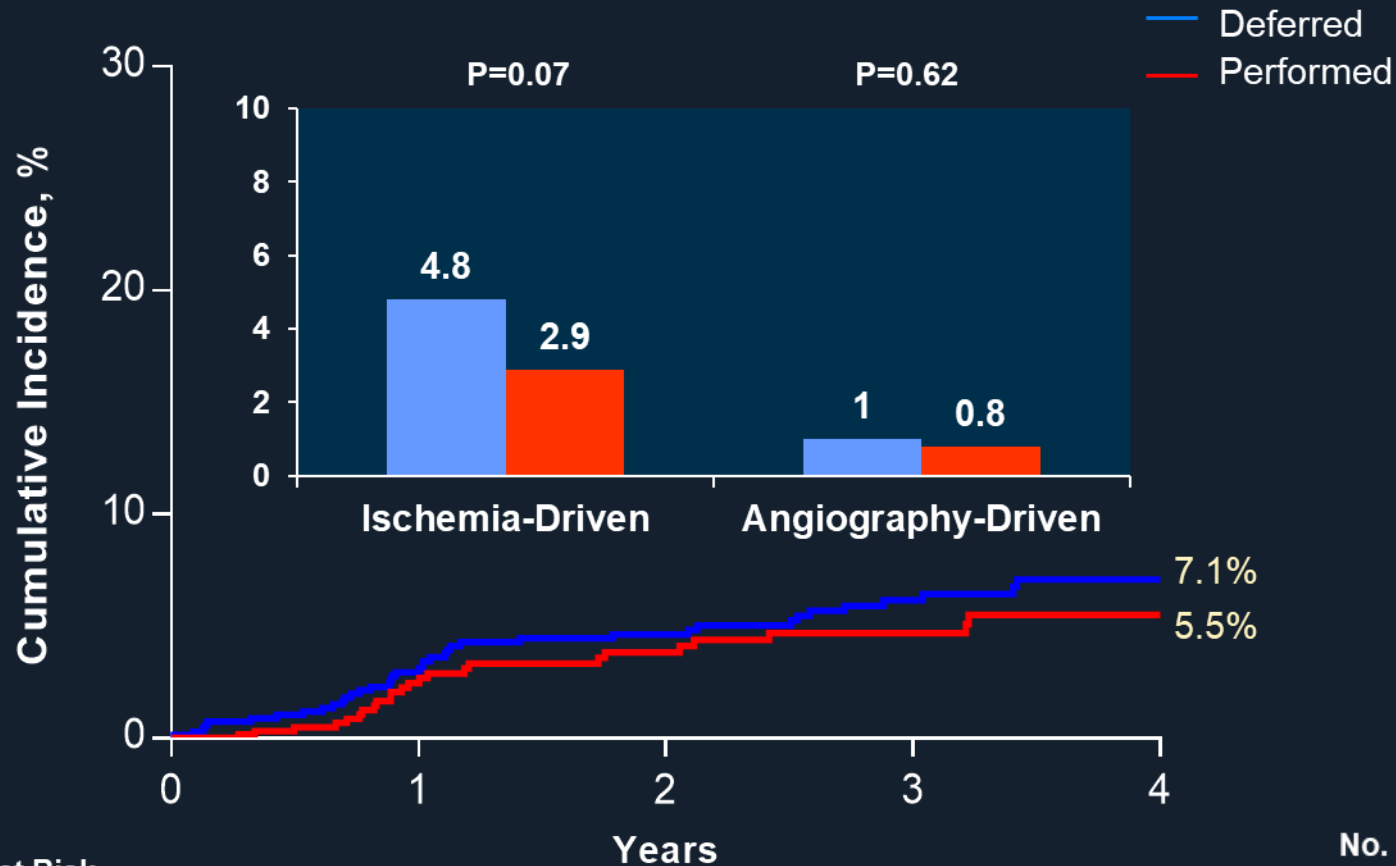

Matched Population

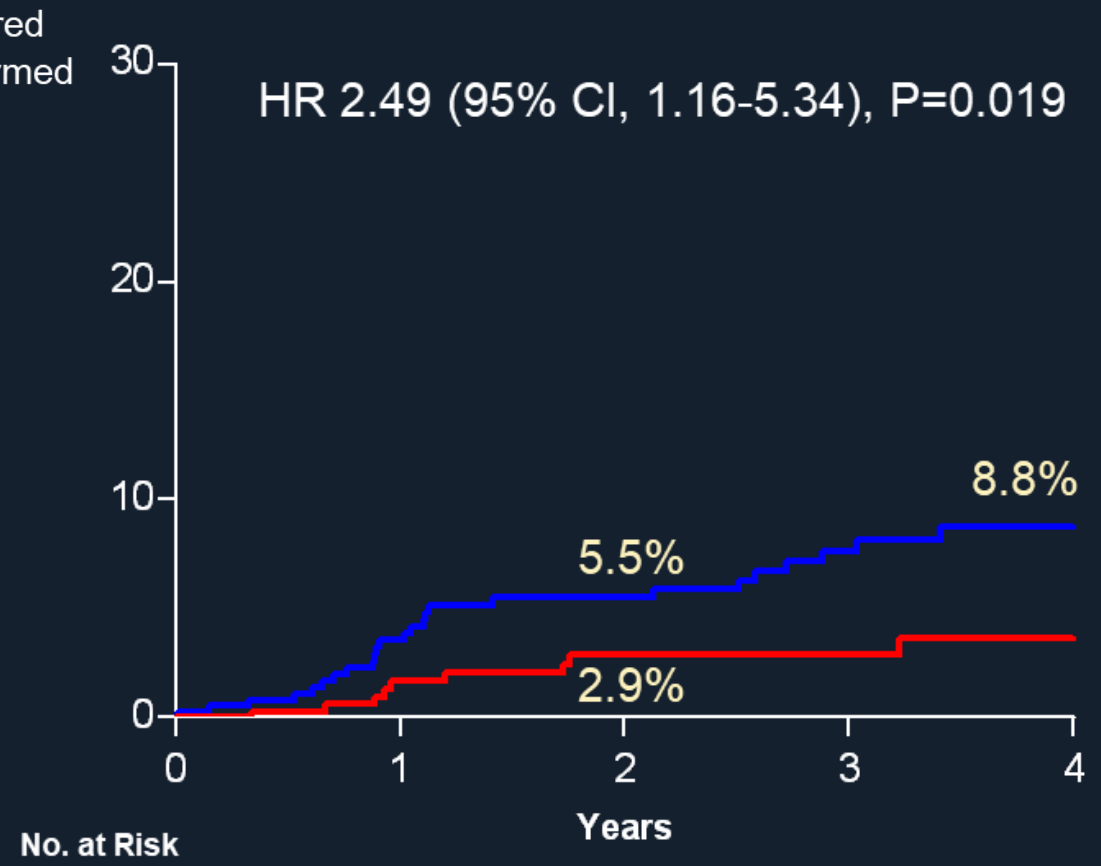

No. at Risk	Years	0	1	2	3	4
Deferred		683	598	500	371	176
Performed		683	467	361	261	154

No. at Risk	Years	0	1	2	3	4
Deferred		368	309	249	186	99
Performed		368	271	211	148	87

Meta-analysis

Study-Level Pooled Analysis Comparing Deferred and Performed PCI in Patients With FFR 0.75-0.80

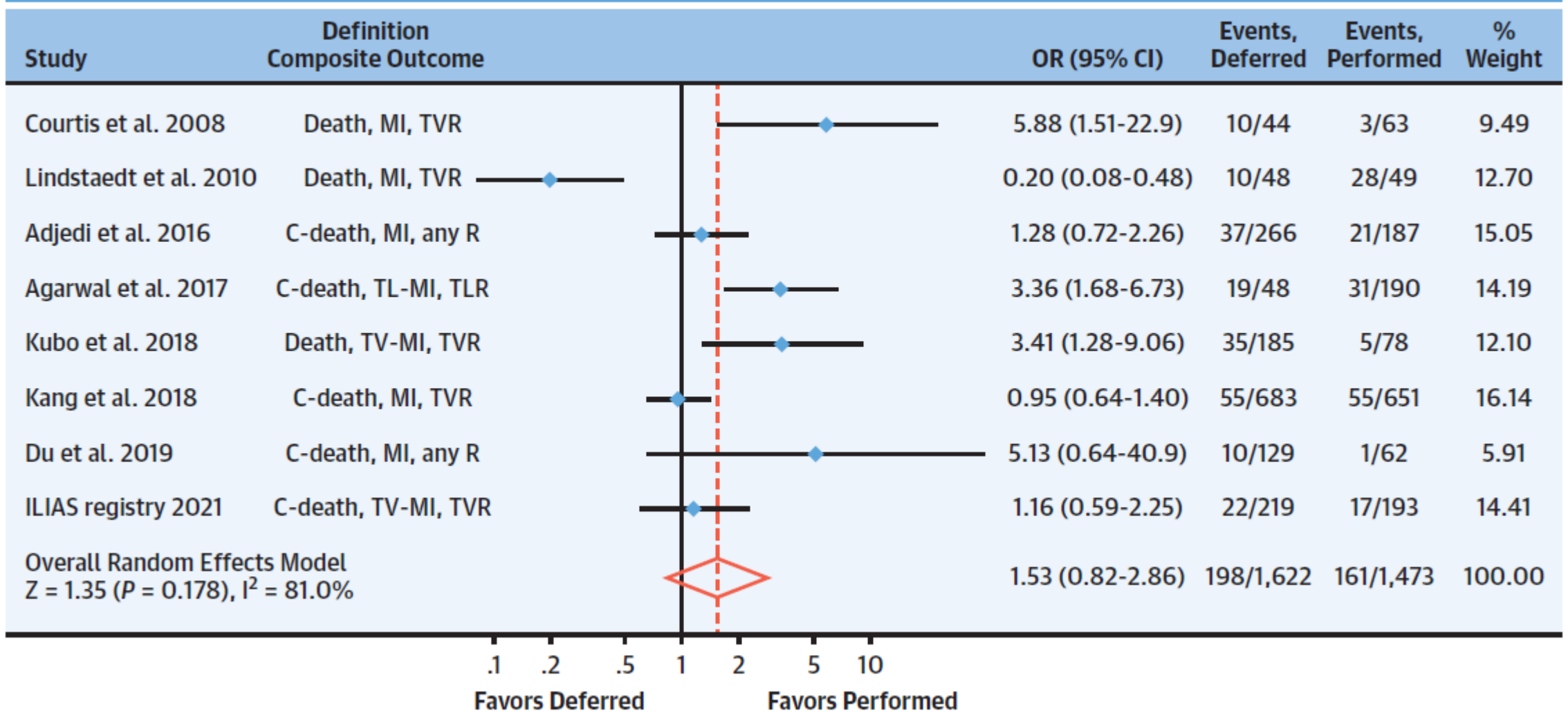

Meta-analysis

MACE

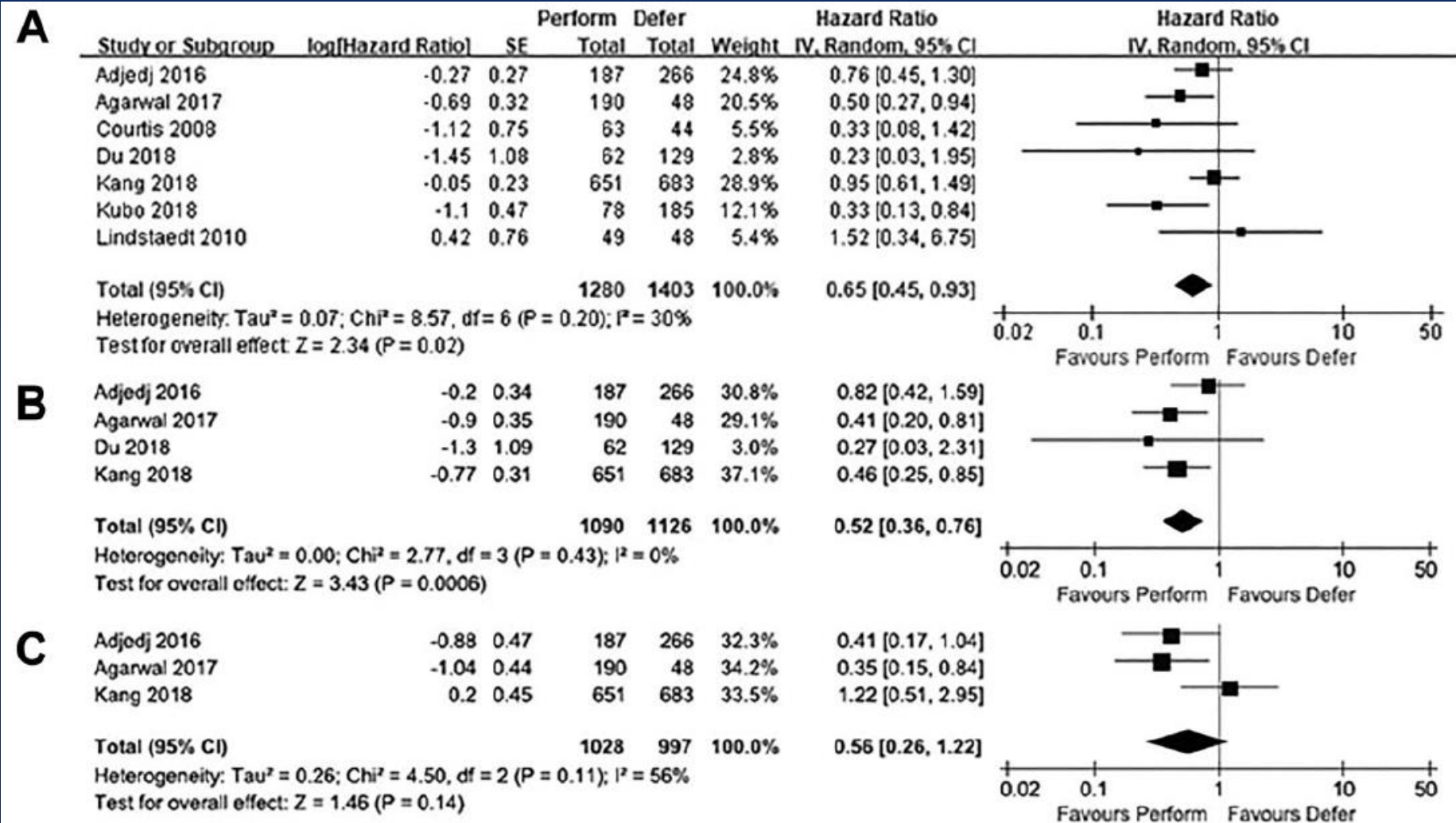

TVR

Death

Meta-analysis

Cardiac Death

MI

Death or MI

D

Adjedj 2016	-1.44	1.08	187	266	35.1%	0.24 [0.03, 1.97]
Kang 2018	-0.09	0.79	651	683	64.9%	0.91 [0.19, 4.30]
Total (95% CI)			838	949	100.0%	0.57 [0.16, 2.01]
Heterogeneity: Tau ² = 0.02; Chi ² = 1.02, df = 1 (P = 0.31); I ² = 2%						
Test for overall effect: Z = 0.88 (P = 0.38)						

E

Adjedj 2016	-0.38	0.71	187	266	30.6%	0.68 [0.17, 2.75]
Agarwal 2017	-2.31	1.47	190	48	15.0%	0.10 [0.01, 1.77]
Kang 2018	1.31	0.55	651	683	35.1%	3.71 [1.26, 10.89]
Kubo 2018	0.15	1.2	78	185	19.3%	1.16 [0.11, 12.21]
Total (95% CI)			1106	1182	100.0%	1.03 [0.26, 4.03]
Heterogeneity: Tau ² = 1.09; Chi ² = 7.39, df = 3 (P = 0.06); I ² = 59%						
Test for overall effect: Z = 0.04 (P = 0.97)						

F

Adjedj 2016	-0.73	0.39	187	266	32.8%	0.48 [0.22, 1.03]
Agarwal 2017	-1.25	0.35	190	48	33.6%	0.29 [0.14, 0.57]
Kang 2018	0.73	0.35	651	683	33.6%	2.08 [1.04, 4.12]
Total (95% CI)			1028	997	100.0%	0.66 [0.20, 2.19]
Heterogeneity: Tau ² = 0.99; Chi ² = 17.04, df = 2 (P = 0.0002); I ² = 88%						
Test for overall effect: Z = 0.68 (P = 0.50)						

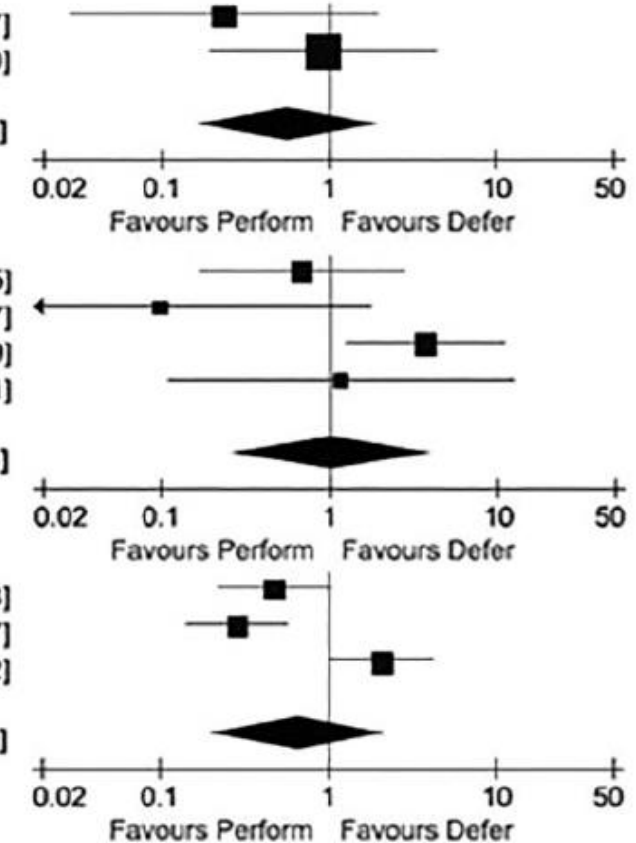

GzFFR RCT : Defer vs. PCI in Gray-zone FFR

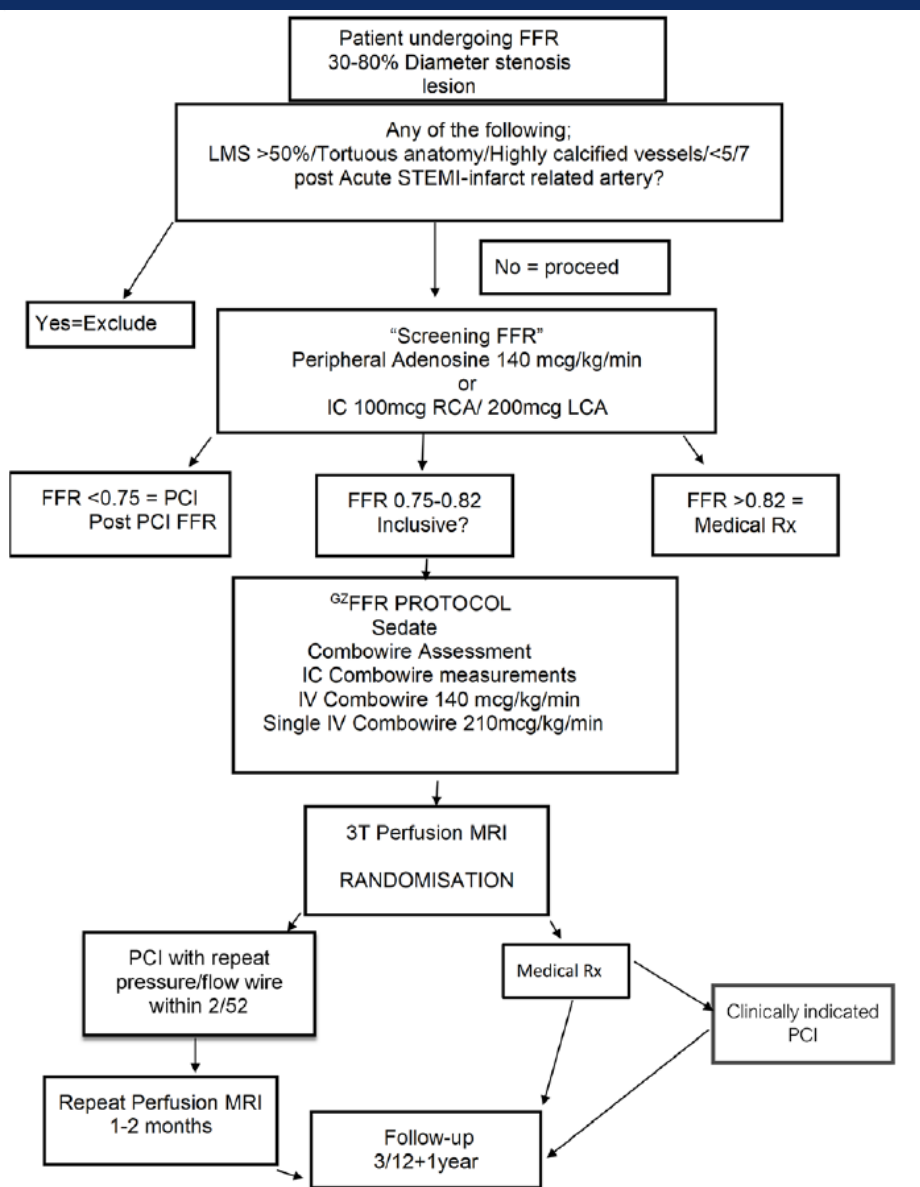

Table 1 Risk factors according to treatment strategy and symptom status, previous cardiac history and mode of presentation at time of recruitment

Variable	OMT n=52	PCI n=52
Age	61 (SD 9.0)	60 (SD 8.0)
Male	39 (75%)	40 (76.9%)
Female	13 (25%)	12 (23.1%)
Current smoker	13 (25%)	21 (40.3%)
Previous smoking	13 (25%)	11 (21.1%)
HTN	44 (84.6%)	31 (59.6%)
Hyperlipidaemia	31 (59.6%)	38 (73.1%)
T2DM	10 (19.2%)	10 (19.2%)
IDDM	2 (3.8%)	2 (3.8%)
FHX CAD	38 (73.1%)	33 (63.5%)
PVD	4 (7.7%)	6 (11.5%)
Cerebrovascular disease	4 (7.7%)	4 (7.7%)

GzFFR RCT : Defer vs. PCI in Gray-zone FFR

Table 3 Quantitative coronary angiographic data according to treatment strategy

Variable	OMT (n=52)	PCI (n=52)
Diameter stenosis (%)	44 (8)	45 (10)
Area stenosis (%)	69 (8)	69 (10)
Lesion length (mm)	10 (4)	10 (4)
APPROACH Score (%)	32 (9)	32 (8)

eTable 5: This table includes all patients with MRI data at enrollment and demonstrates the numbers of patients according to the numbers of segments with detectable ischemia in the ^{GZ}FFR territory.

Total number Grey Zone FFR segments per patient with any detectable ischemia	0	1	2	3	4
Total Patient number (n=98)(%)	74(75.5%)	8(8.2%)	10(10.2%)	5(5.1%)	1(1%)

GzFFR RCT : Defer vs. PCI in Gray-zone FFR

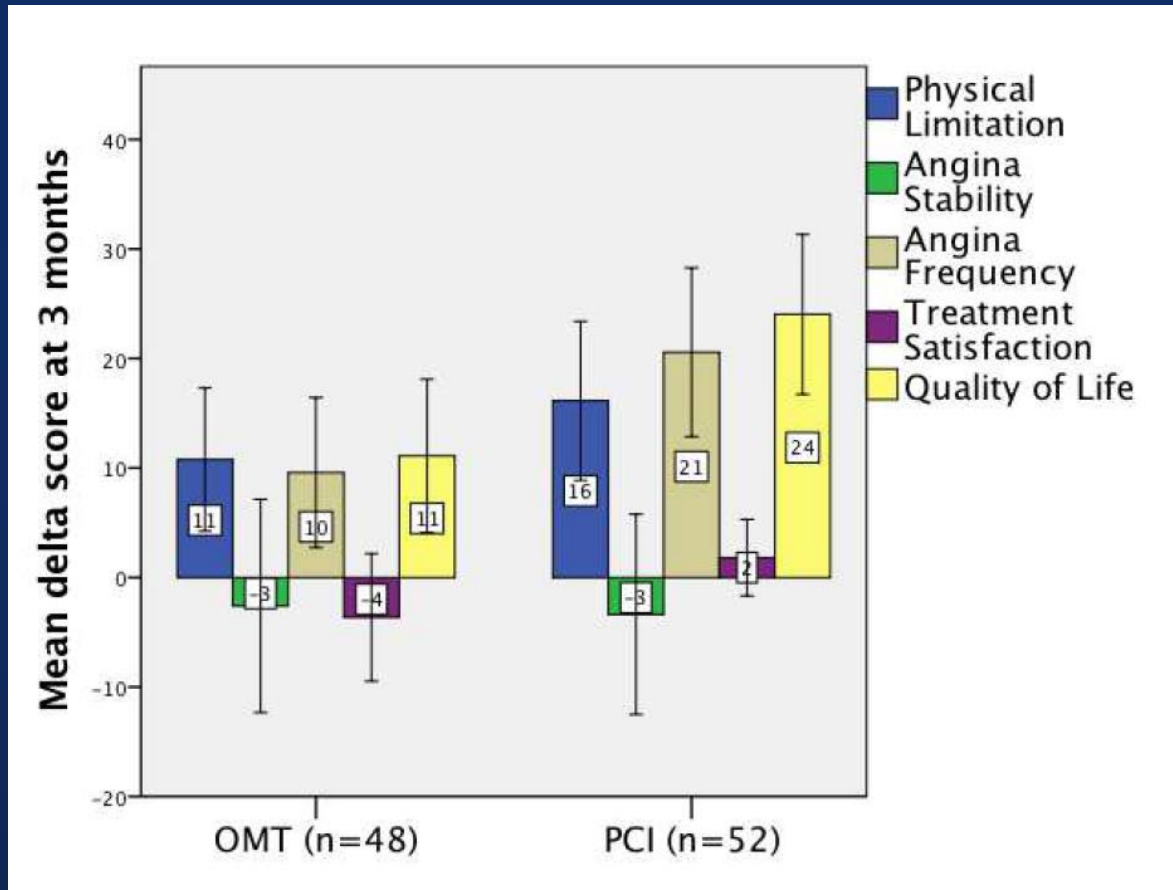

Secondary outcomes at 3 months

This study was not powered to detect a difference in hard clinical endpoints. All-cause mortality at 3 months was 3/52 (5.7%) in OMT group (all confirmed non-cardiac deaths) vs 0/52 (0%) in PCI group.

eTable 7: 12-month Seattle Angina Score Delta values according to treatment strategy

Questionnaire Parameter	Group	N	Mean delta	Standard. Deviation	P value
SAQ Summary Delta Score	OMT	45	9.8	18	0.208
	PCI	44	15.1	21	
Physical limitation Delta Score	OMT	45	2.9	20	0.07
	PCI	44	11.6	24	
Anginal stability Delta Score	OMT	45	.5	32	0.62
	PCI	44	-2.8	32	
Anginal frequency Delta Score	OMT	45	13.5	25	0.77
	PCI	44	15.2	29	
Treatment satisfaction Delta Score	OMT	45	-2.3	16	0.35
	PCI	44	.9	17	
Quality of Life Delta Score	OMT	45	12.9	24	0.27
	PCI	44	18.5	24	

Decision-Making in Gray-zone FFR

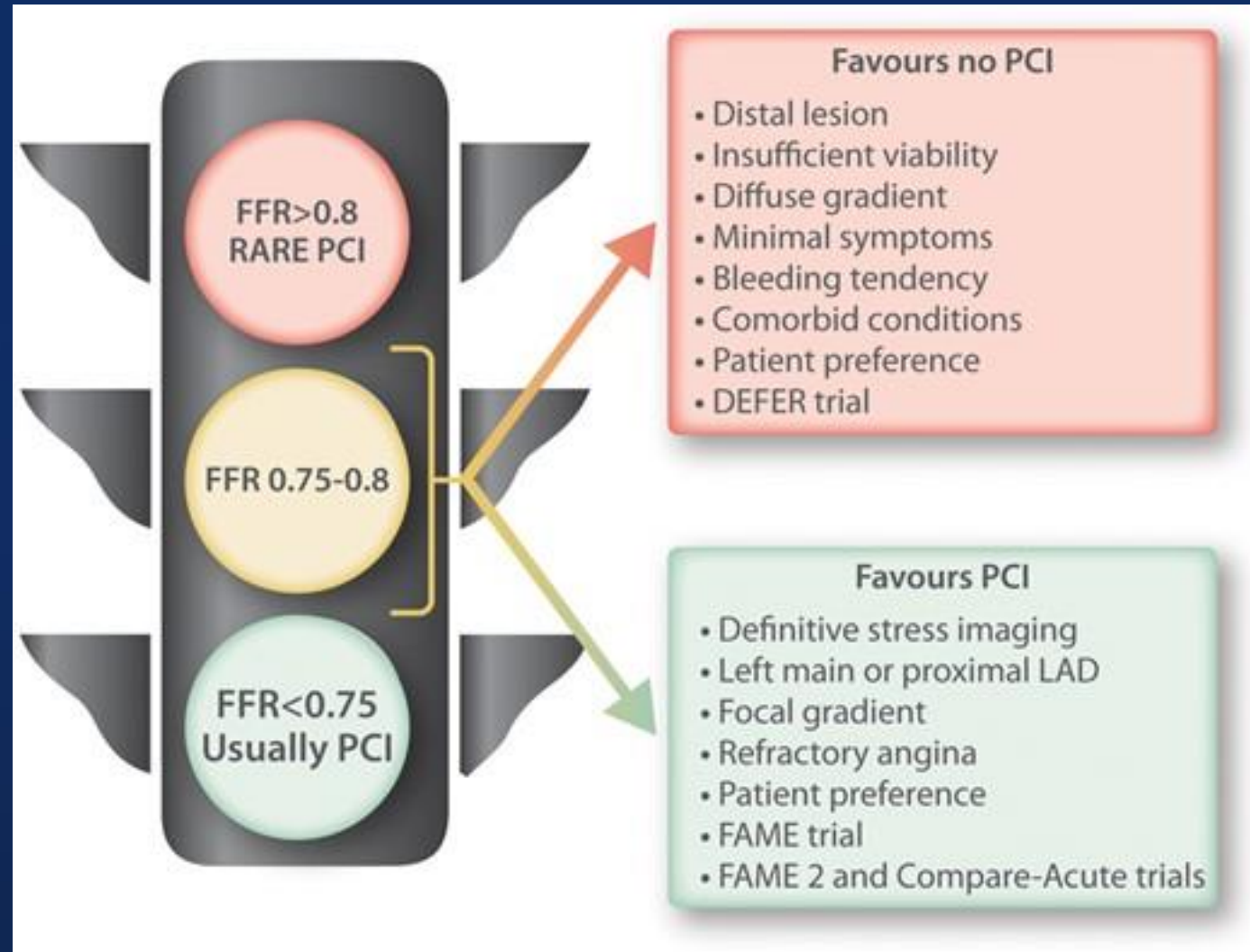

FAME 3

1500 Multivessel CAD Patients 48 centers

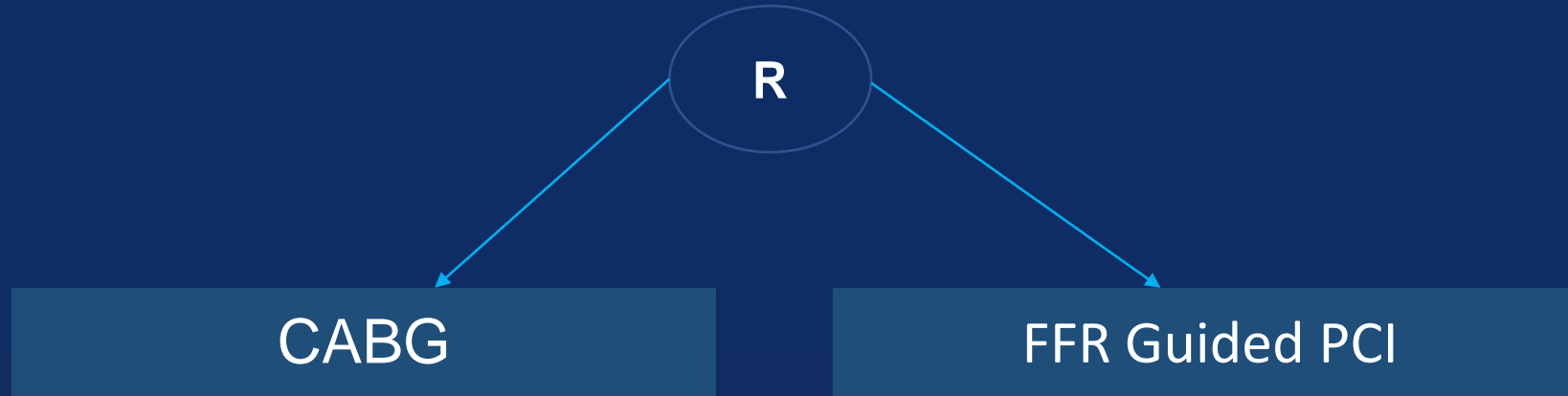

Primary Endpoint at 1 year:
Death from any cause, myocardial infarction,
Stroke, or repeat revascularization

FAME 3

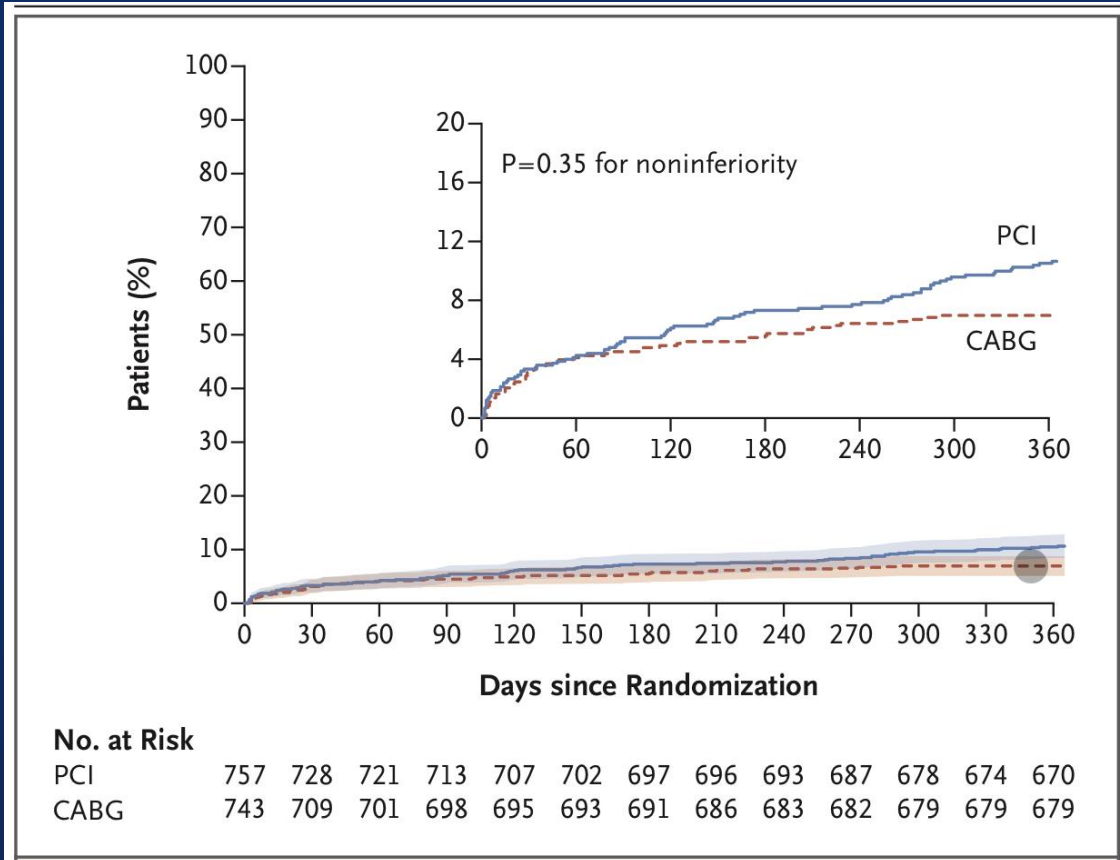

FFR-guided PCI **did not** meet criteria for **non-inferiority** compared with CABG in patients with angiographic three-vessel disease.

N Engl J Med 2022;386:128-37. DOI:
10.1056/NEJMoa2112299

FAME 3

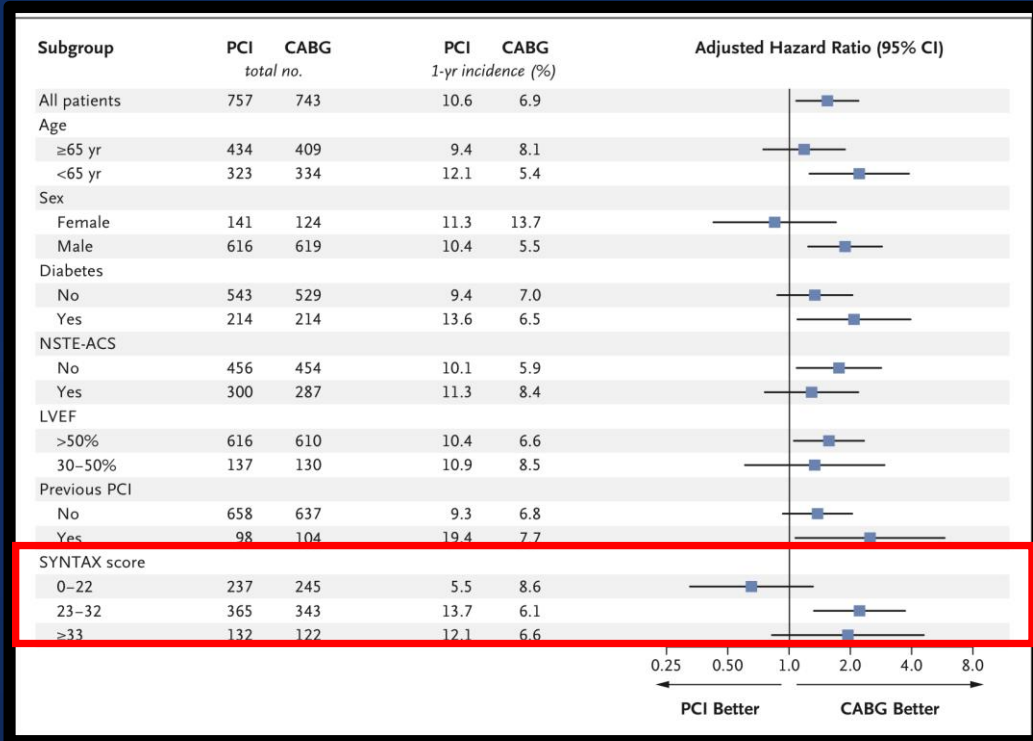

* benefit with PCI among patients with low SYNTAX scores

Table 2. Angiographic and Procedural Characteristics.*

Characteristic	PCI (N = 757)	CABG (N = 743)
Median time to procedure (IQR) — days	4 (1–13)	13 (6–26)
Median procedure duration (IQR) — min	87 (67–113)	197 (155–239)
Median length of hospital stay (IQR) — days	3 (1–7)	11 (7–16)
No. of lesions	4.3±1.3	4.2±1.2
At least one chronic total occlusion — no./total no. (%)	157/755 (20.8)	171/739 (23.1)
At least one bifurcation lesion — no./total no. (%)	522/755 (69.1)	491/739 (66.4)
SYNTAX score†	26.0±7.1	25.8±7.1
SYNTAX score category — no./total no. (%)†		
Low, 0 to 22	237/734 (32.3)	245/710 (34.5)
Intermediate, 23 to 32	365/734 (49.7)	343/710 (48.3)
High, >32	132/734 (18.0)	122/710 (17.2)
PCI characteristics		
Staged procedure — no./total no. (%)	166/750 (22.1)	NA
No. of stents	3.7±1.9	NA
Median total length of stents placed (IQR) — mm	80 (52–116)	NA
Intravascular imaging used — no./total no. (%)	87/744 (11.7)	NA
CABG characteristics		
Multiple arterial grafts — no./total no. (%)	NA	173/705 (24.5)
No. of distal anastomoses	NA	3.4±1.0
LITA used as graft — no./total no. (%)	NA	684/705 (97.0)
Off-pump surgery — no./total no. (%)	NA	168/698 (24.1)
FFR used before CABG — no./total no. (%)	NA	72/718 (10.0)

*IVUS/OCT was used in only 12% of patients

FRAME-AMI

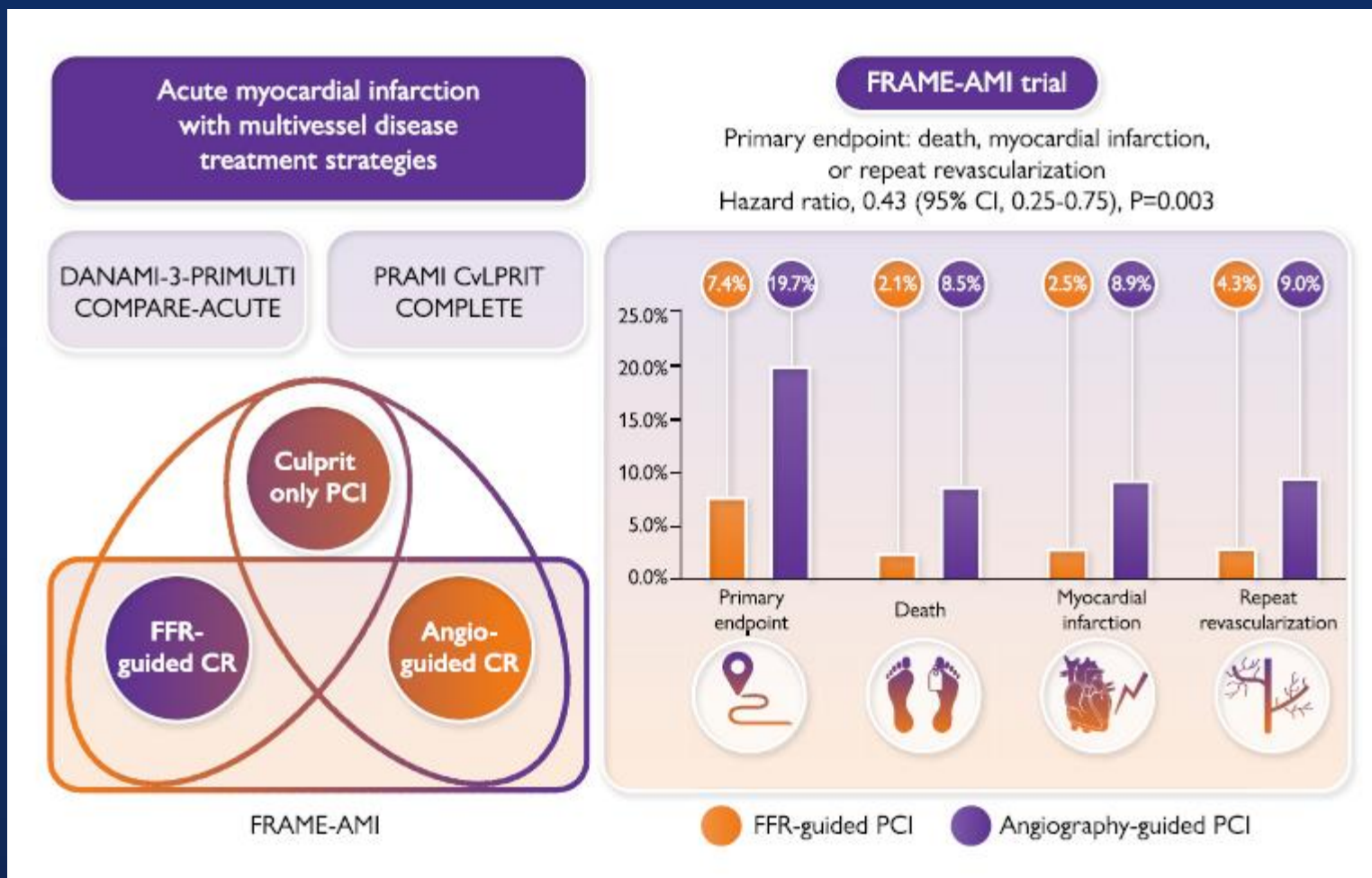

JM Lee et al. Eur Heart J 2023 Feb 7;44(6):473-484

FRAME-AMI

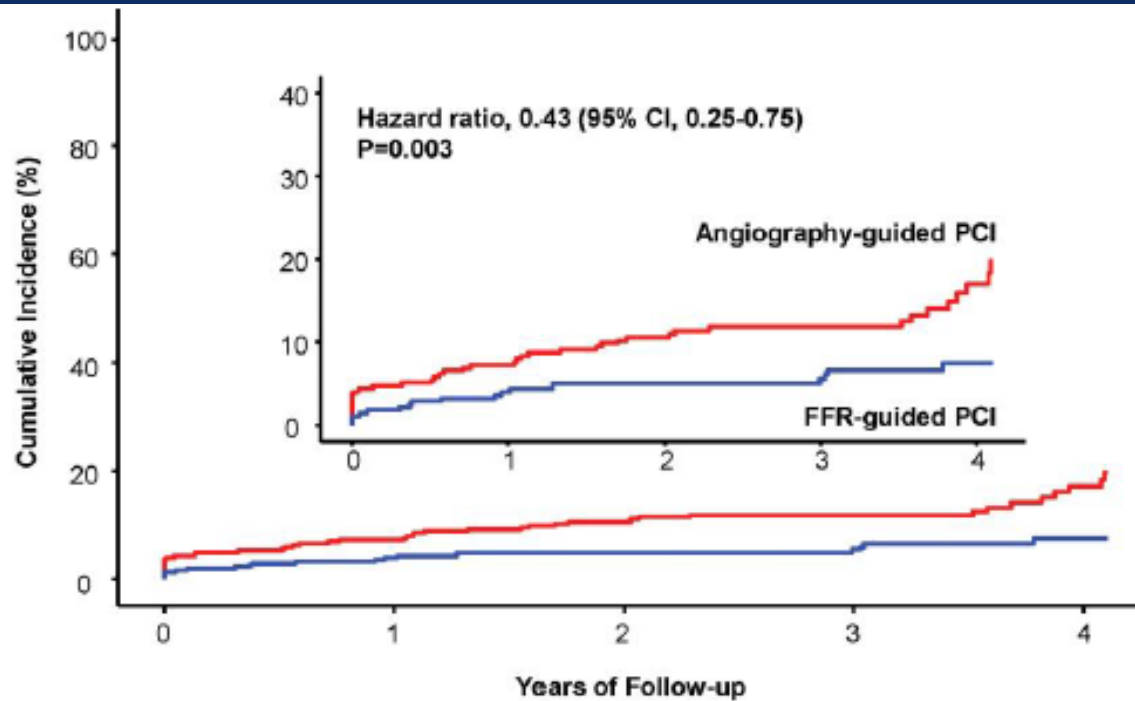

No. at Risk

Angiography-guided PCI	278	257	223	173	74
FFR-guided PCI	284	271	237	186	79

In acute MI and multivessel coronary artery disease, **selective PCI using FFR was superior** to routine PCI based on angiography for non-infarct-related artery lesions regarding the risk of death, MI, or repeat revascularization.

JM Lee et al. Eur Heart J 2023 Feb 7;44(6):473-484

FULL REVASC Trial

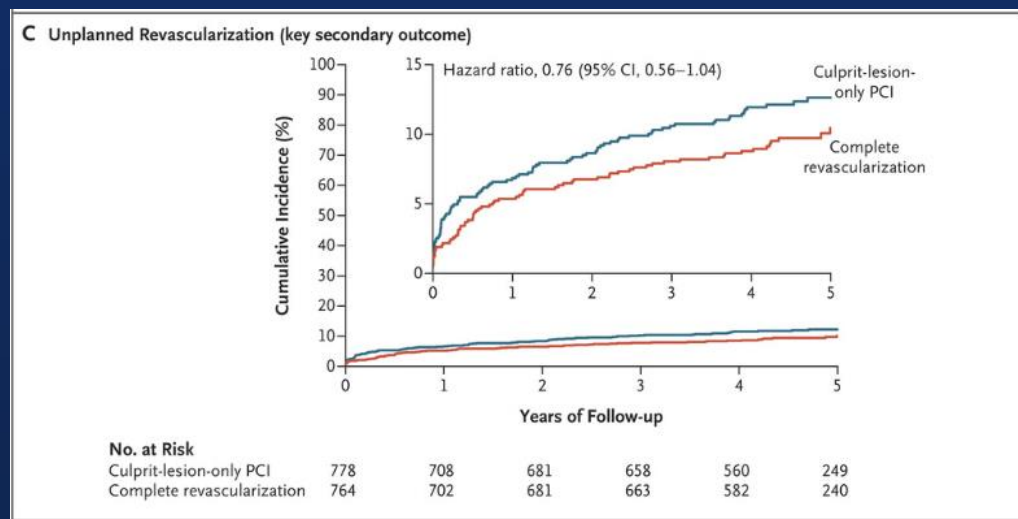
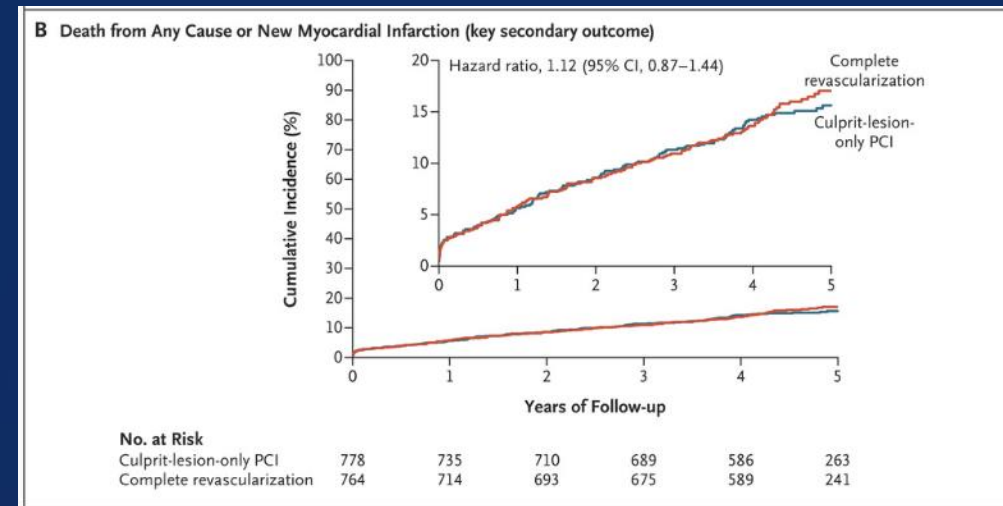
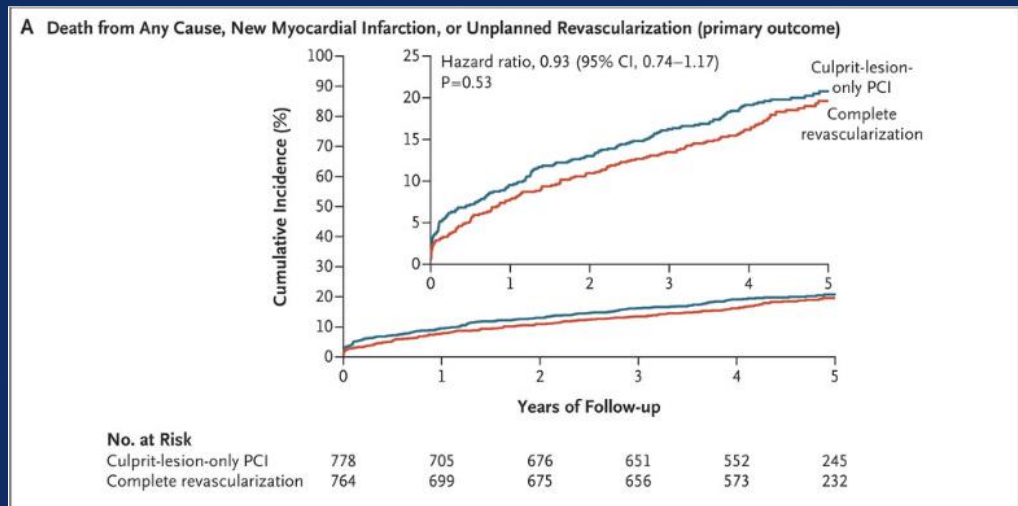

The FULL REVASC trial showed that, among patients with STEMI or very-high-risk NSTEMI and multivessel coronary artery disease, **a strategy of routine FFR-guided complete revascularization was not superior to a strategy of culprit-lesion-only PCI** in reducing the risk of death from any cause, myocardial infarction, or unplanned revascularization at a median follow-up of 4.8 years.

Poststenting FFR

CENTRAL ILLUSTRATION: Impact of Post-PCI FFR Stratified by Coronary Artery

Meta-Analysis of Individual Patient-Level Data



N = 2,760
3,336 vessels



9 studies
4 randomized trials
5 observational studies



Post-PCI FFR

Mean Post-PCI FFR and Predictive Capacity for TVF Stratified by Vessel

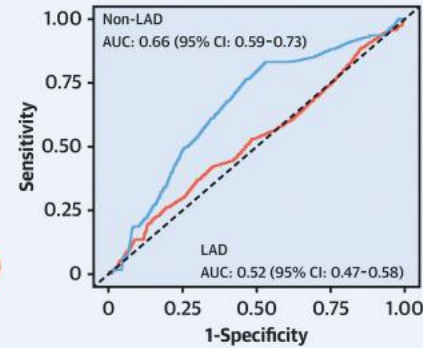
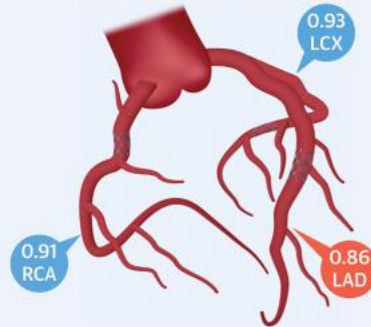

Risk of TVF Stratified by Post-PCI FFR in LAD and Non-LAD

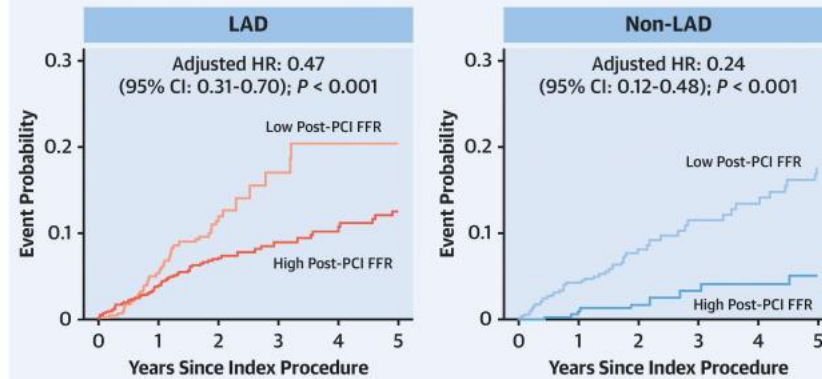

Collet C, et al. J Am Coll Cardiol Interv. 2023;16(19):2396-2408.

Poststenting FFR

CENTRAL ILLUSTRATION: Value of Poststenting Fractional Flow Reserve

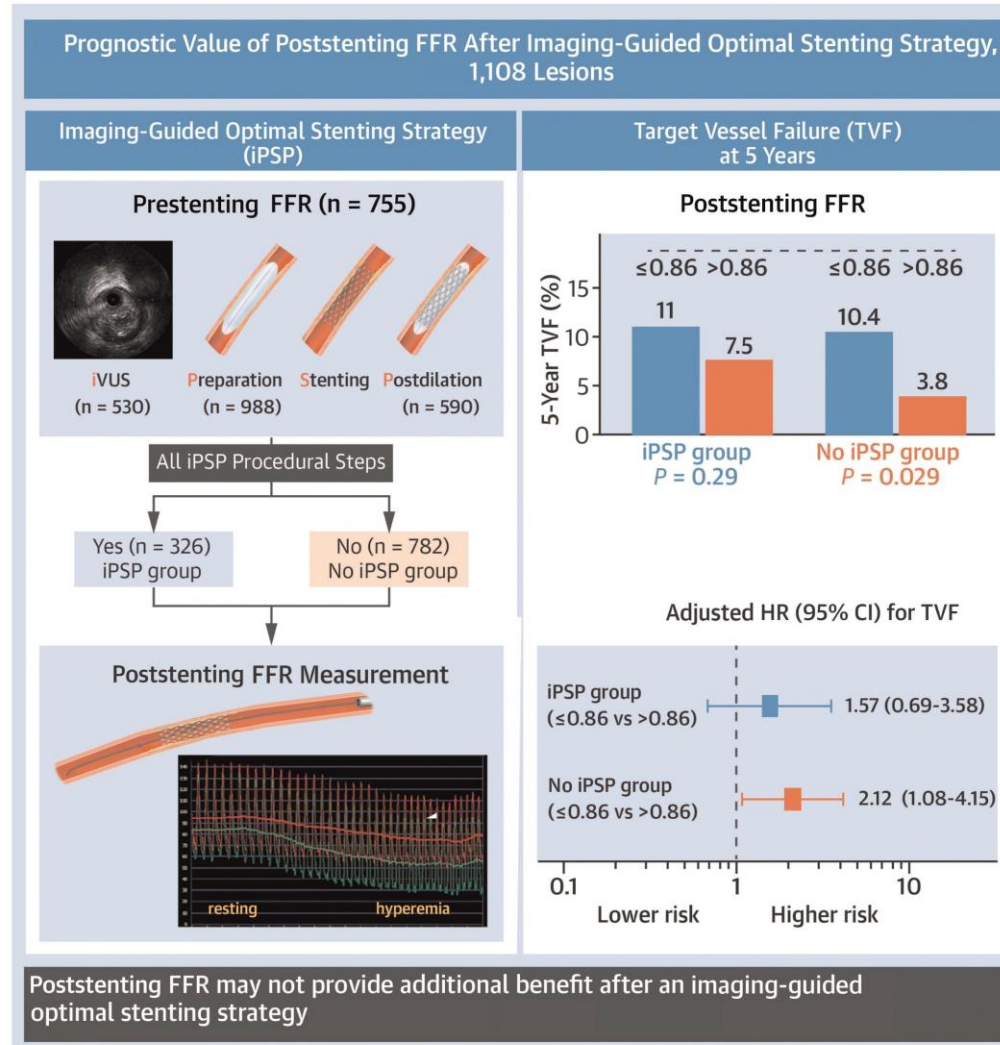

Ahn J-M, et al. J Am Coll Cardiol Interv. 2024;17(7):907-916.

IVUS

Residual Plaque Predicts Edge Restenosis

	Population	DES	F/U time	Predictor
SIRIUS¹	6 edge restenosis vs. 162 controls	SES	8 mo	Ref segment PB 60% vs. 41% (p<0.01)
TAXUS²	276 edge stenosis	PES	9 mo	Ref segment PB 47%

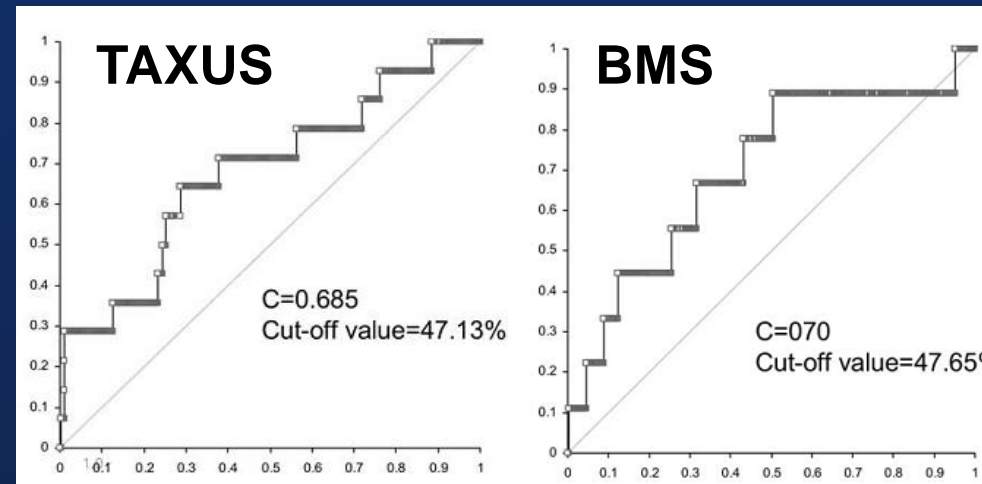

predict 9-mo edge restenosis

¹ Am J Cardiol 2005;96:1251-3

² Liu et al. Am J Cardiol 2009;103:501-6

Residual Plaque Predicts DES Thrombosis

	Population	DES	Endpoint	Predictor
Fujii¹	15 ST vs. 45 controls	SES	ST <1 mo	Ref. PB 62% vs. 46%
Okabe²	13 ST vs. 27 controls	DES	ST <1 yr	Ref. PB 66% vs. 56%
Liu³ ↓	20 ST vs. 50 controls	DES	ST <1 yr	Ref. PB 57% vs. 38%

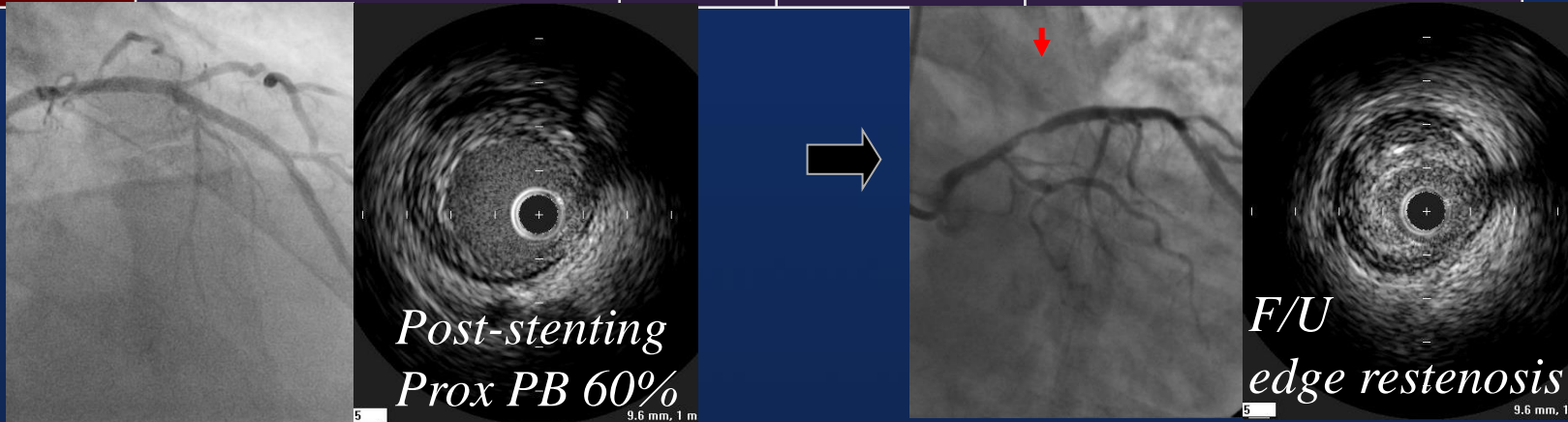

¹ Fujii et al. *J Am Coll Cardiol* 2005;45:995-8

² Okabe et al. *Am J Cardiol* 2007;100:615-20

³ Liu et al. *JACC Cardiovasc Interv.* 2009;2:428-34

Stent Length Predicts DES Failure

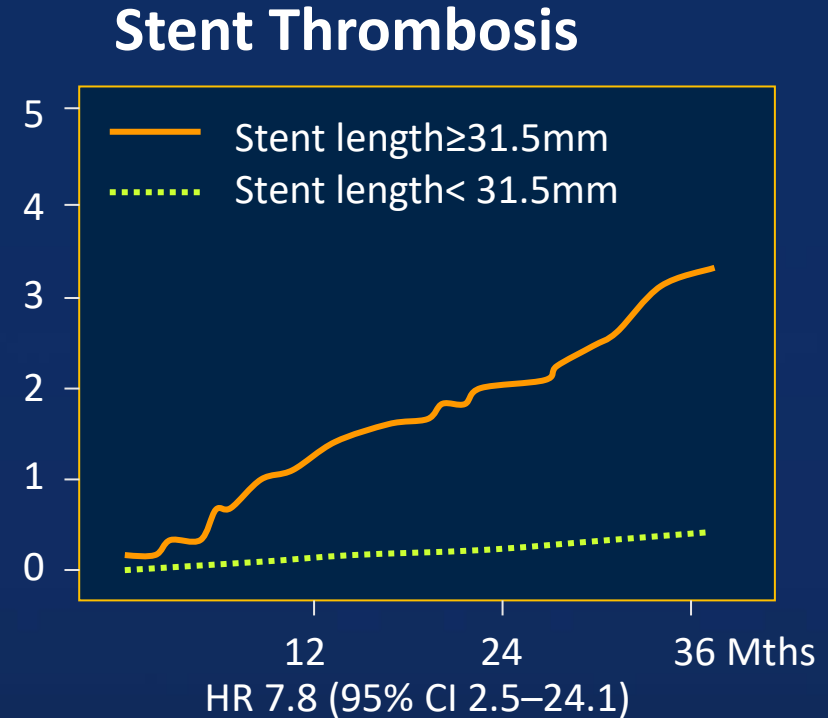
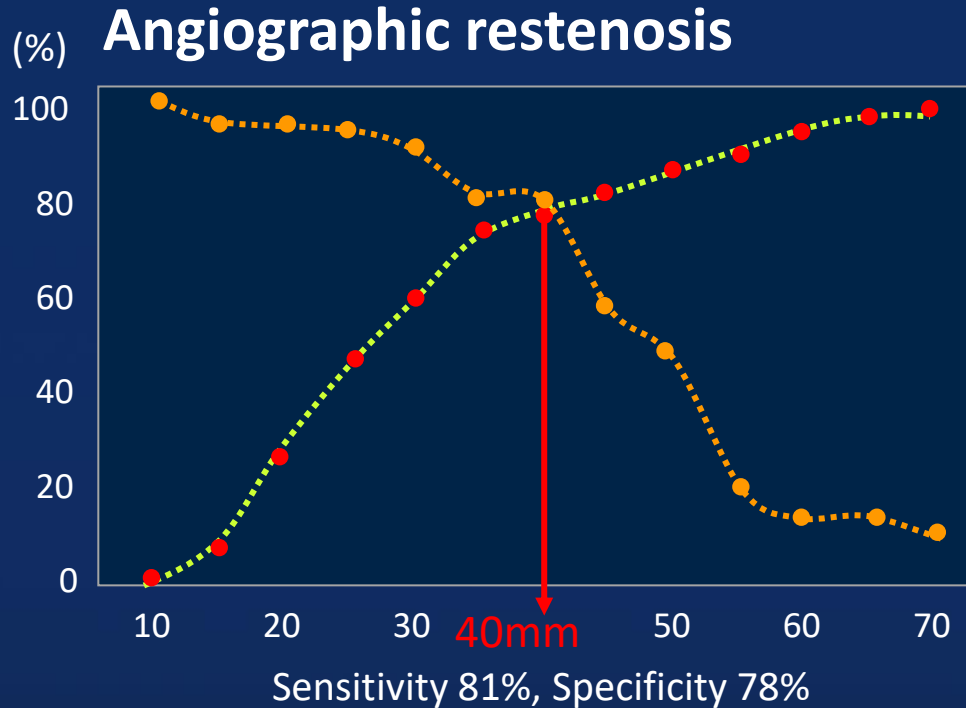

IVUS-guided PCI is necessary to achieve full lesion coverage and to avoid the waste of stent

Hong et al. Eur Heart J 2006;27:1305-10

Suh et al. JACC interv 2010;3:383-9

Underexpansion Predicts DES Restenosis

	Population	DES	Endpoint	Rate of Underexpansion
Fujii ¹	15 ST vs. 45 controls	SES	ST <1 month	<5.0mm ² in 80% vs. 29%
Okabe ²	13 ST vs. 27 controls	DES	ST <1 year	<5.0mm ² in 79% vs. 40%
Liu ³	20 ST vs. 50 controls	DES	ST <1 year	<5.0mm ² in 85% vs. 26%

¹ J Am Coll Cardiol 2005;45:995-8

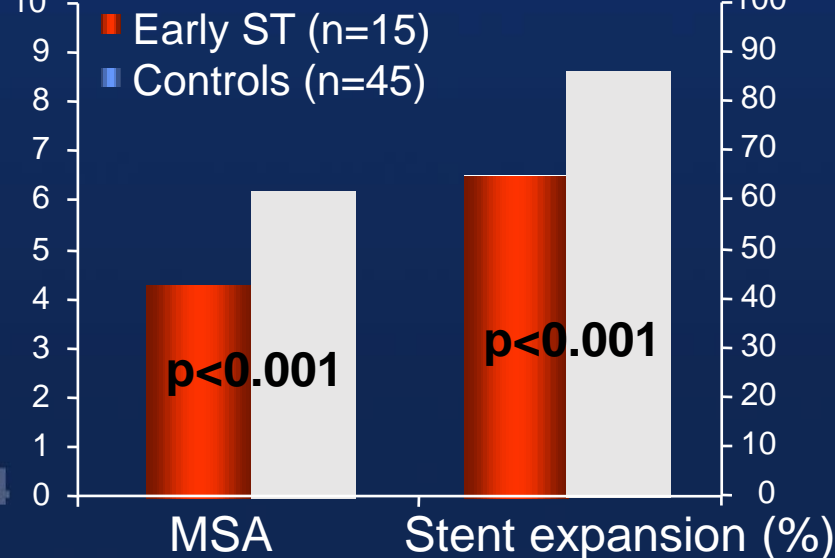

² Am J Cardiol 2007;100:615-20

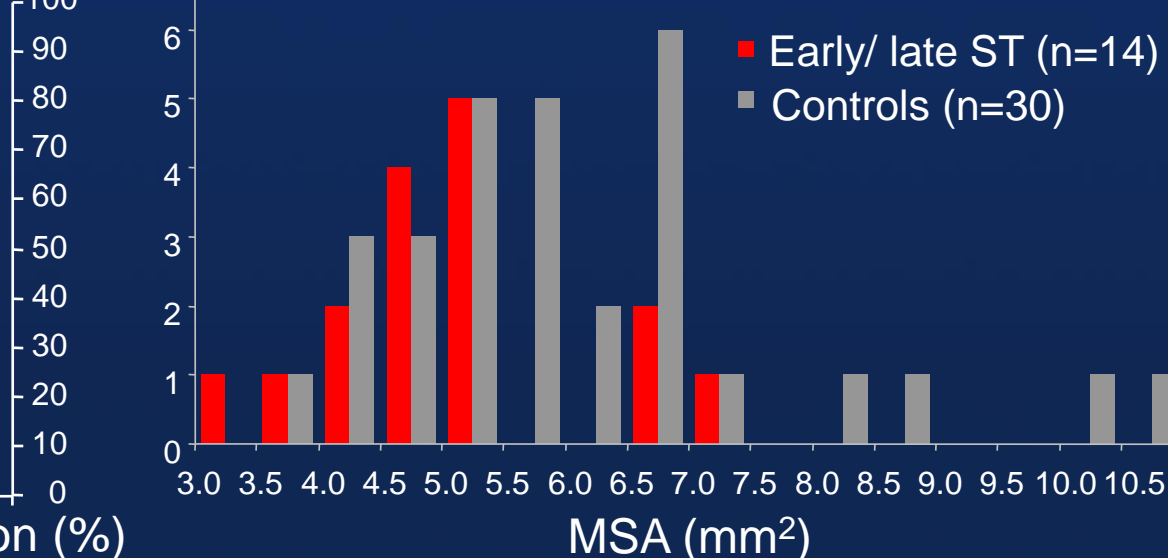

³ JACC interv 2009;2:428-34

Underexpansion Predicts DES Restenosis

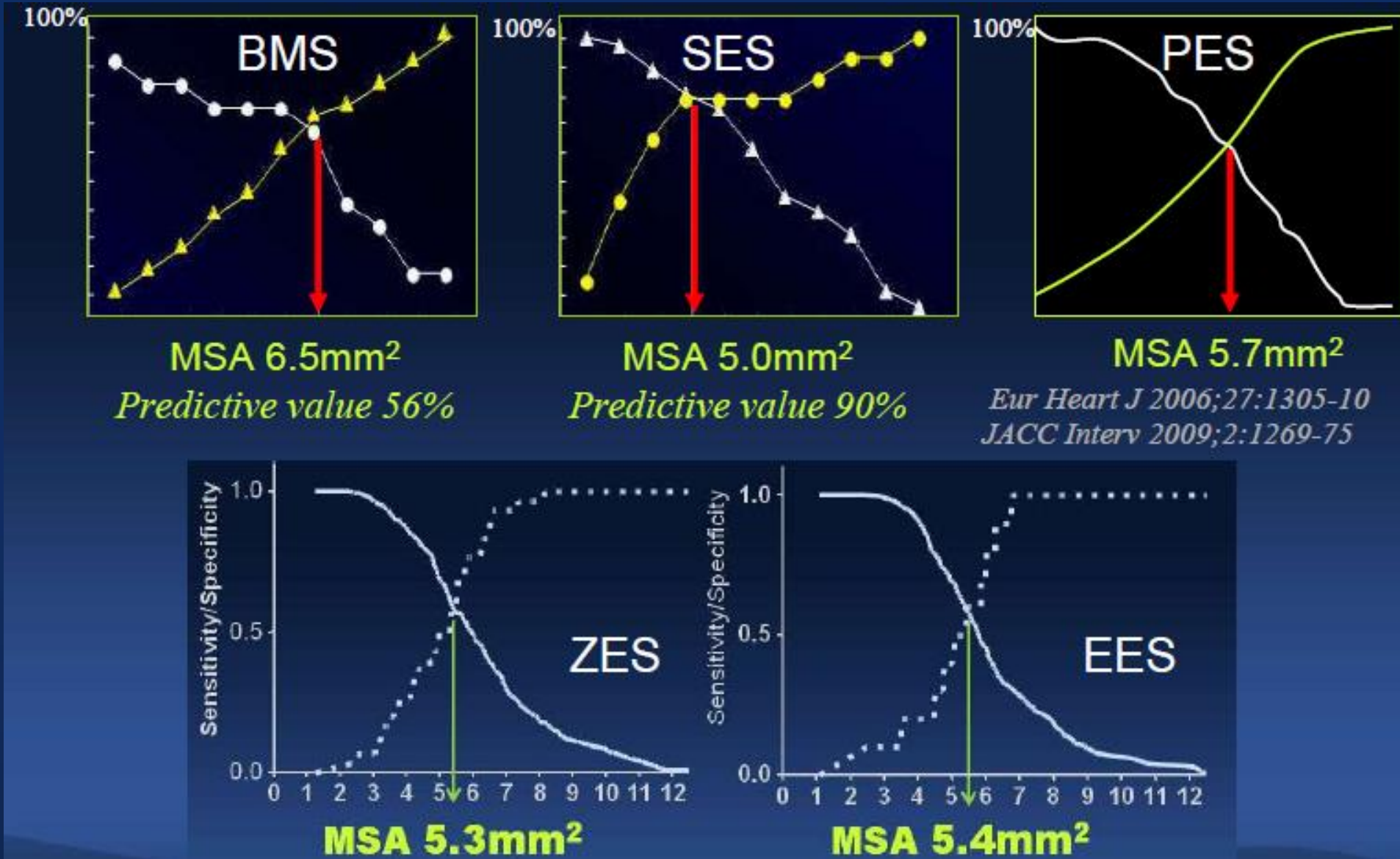

Frequency of Underexpansion and ISR

33.8% had underexpansion of at least one stented segment

Two-stent

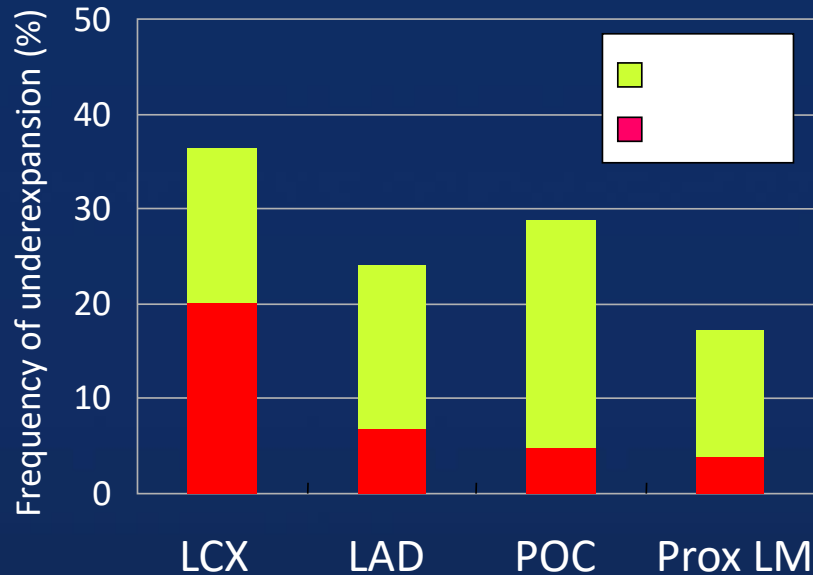

54% had underexpansion in at least one of the 4 stented segments

Single-stent

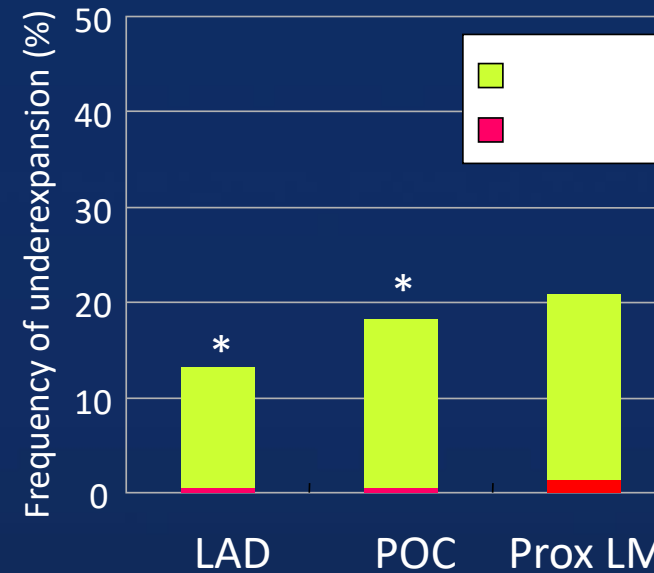

* single-stent vs. two-stent, $p < 0.05$

27% had underexpansion in at least one of the 3 stented segments

Frequency of ISR in LM Lesions

with vs without Underexpansion

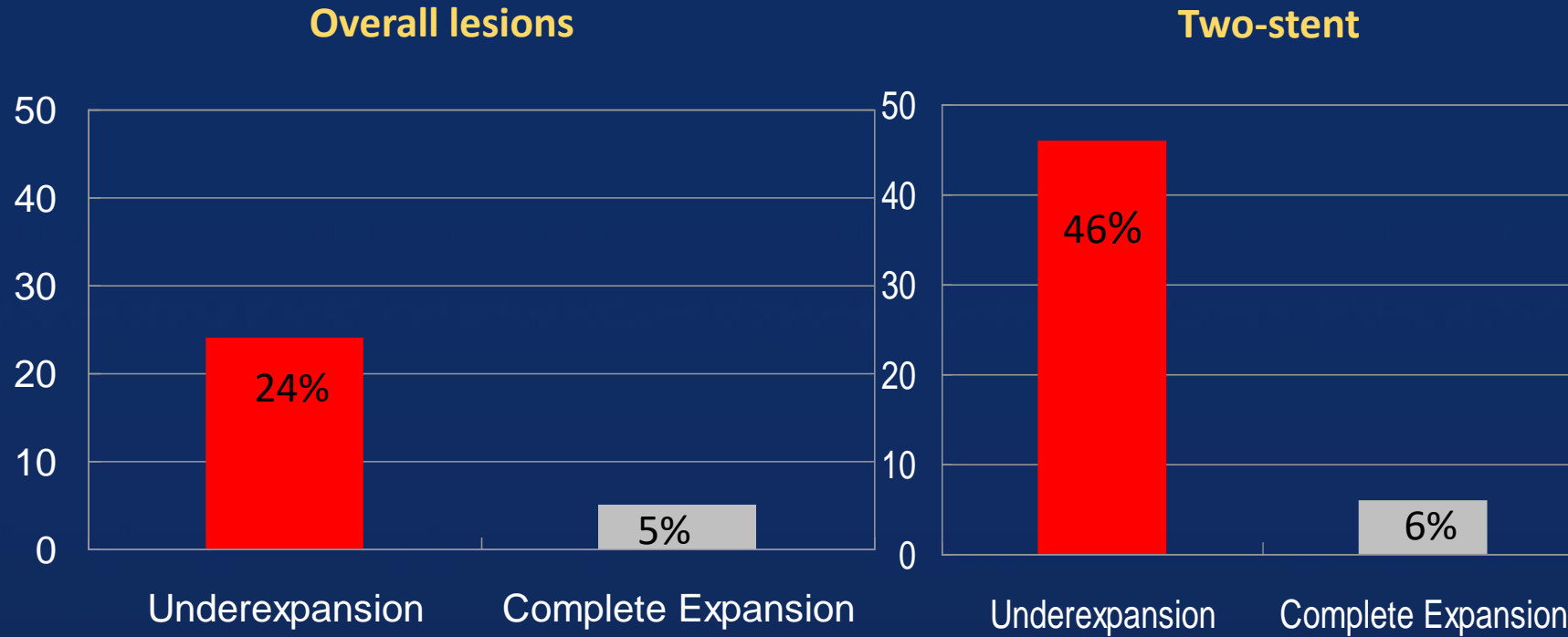

- Underexpansion of at least 1 segment
- Adequate expansion at all sites

Kang et al. Circ Cardiovasc Interv 2011 2011;4:1168-74

ADAPT-DES 1-year Outcomes

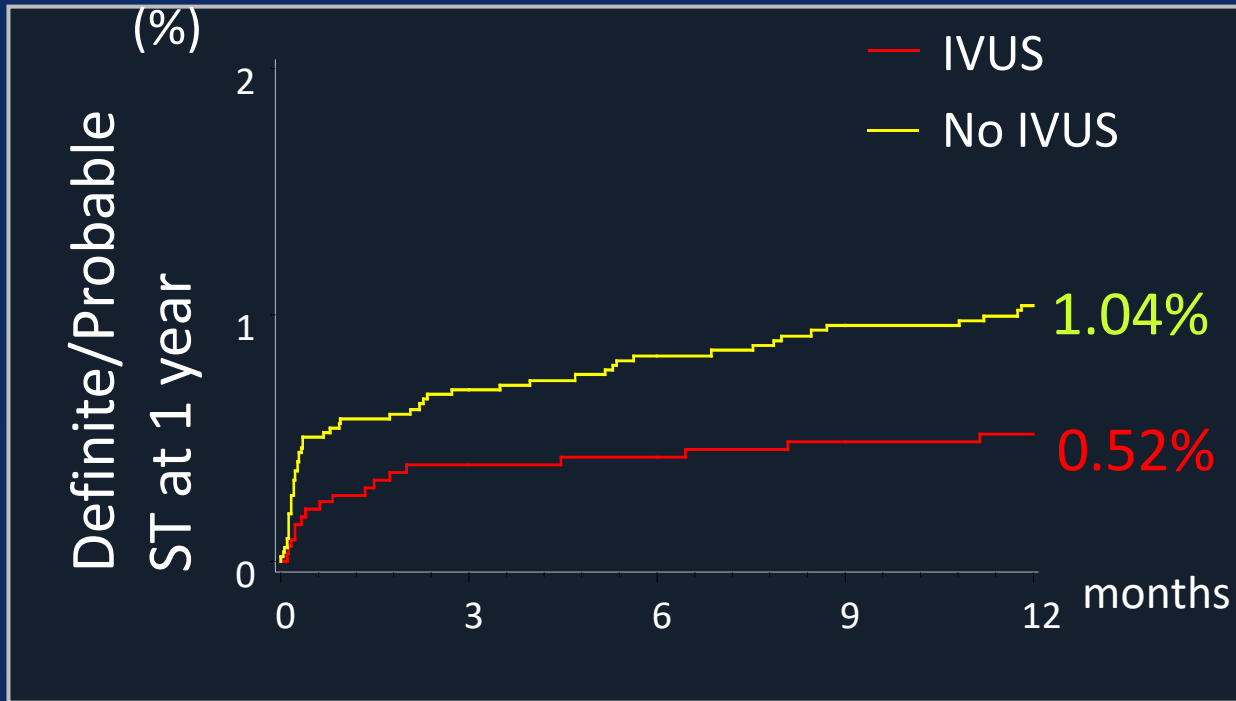

p=0.01
HR 0.50
95%CI 0.29-0.86

	IVUS n = 3349	No IVUS n = 5234	p Value
Definite/probable ST	0.52% (17)	1.04% (53)	0.011
All myocardial infarction	2.46% (81)	3.68% (188)	0.0022
Ischemic driven TVR*	2.42% (81)	3.95% (207)	0.0001

Maehara et al. 2013 TCT

ADAPT-DES 2-YEAR RESULTS

The largest prospective study of IVUS use to date

IVUS Arm Reported Improved Clinical Outcomes

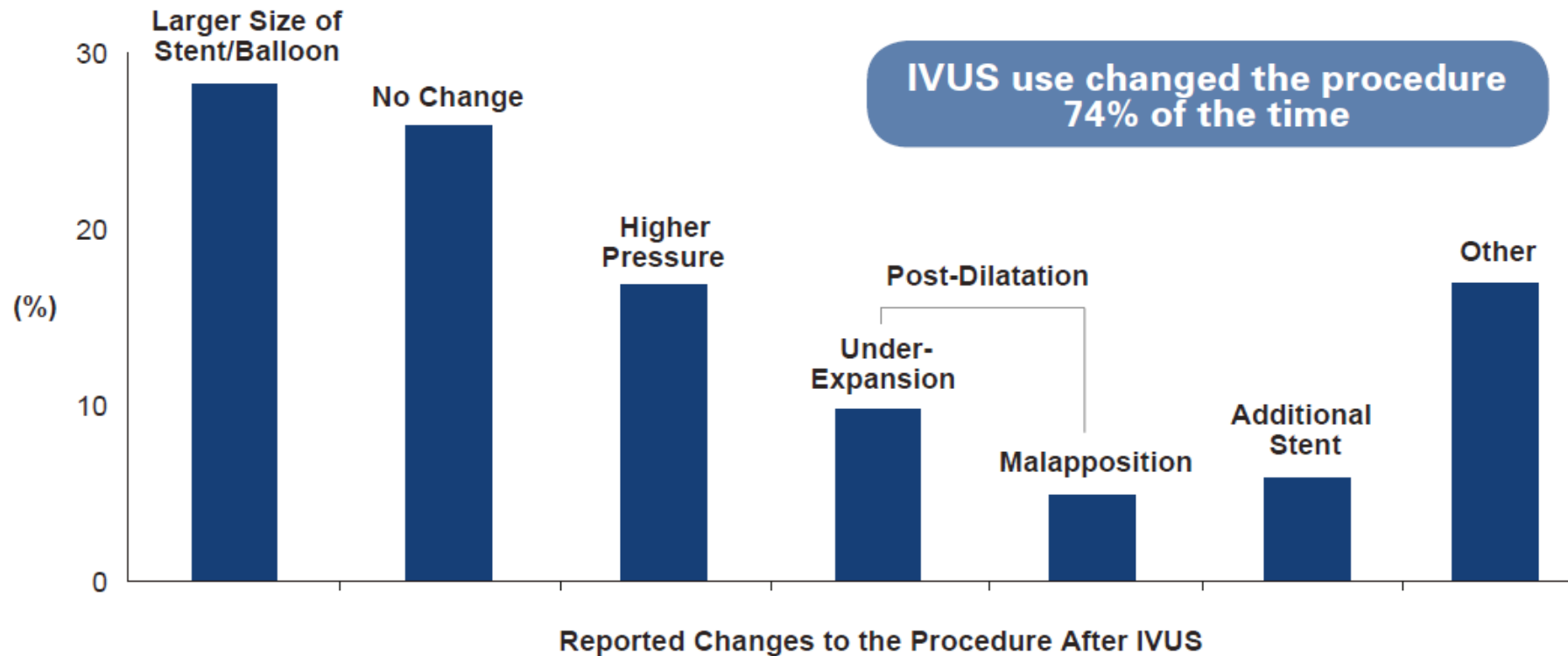

- IVUS use was associated with longer stent length and larger stent size without increasing peri-procedural MI or the number of stents
- IVUS use was associated with reduction of MACE in complex lesions

ADAPT-DES 2-YEAR RESULTS

The largest prospective study of IVUS use to date

Results From IVUS and No IVUS Study Arms

■ No IVUS Use

■ IVUS Use

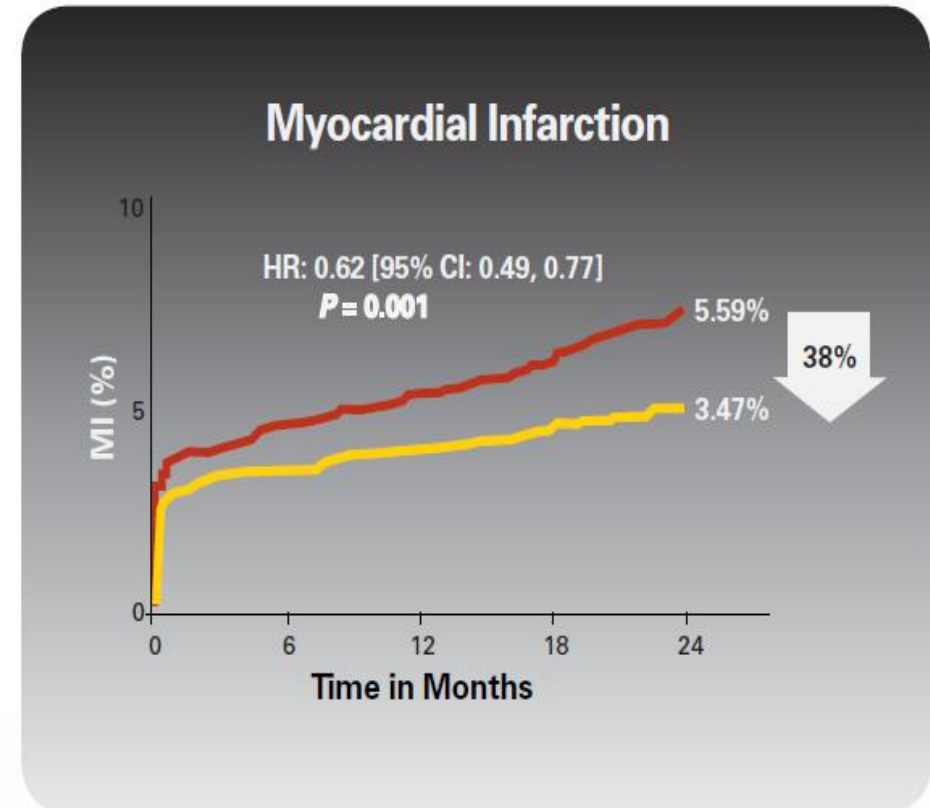
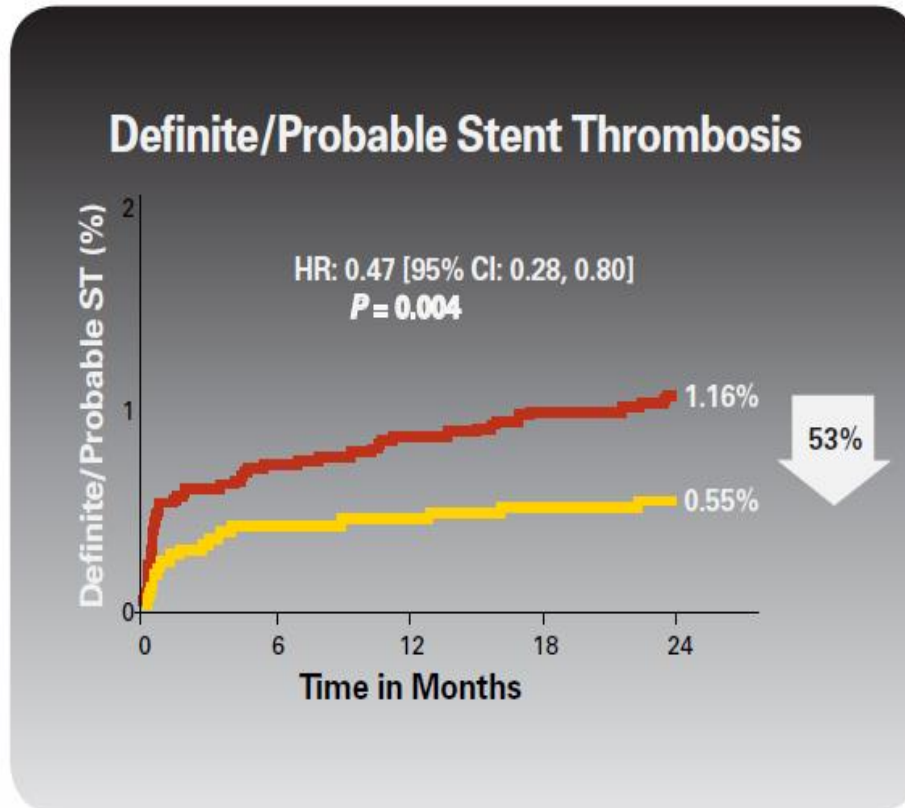

ADAPT-DES 2-years Outcomes

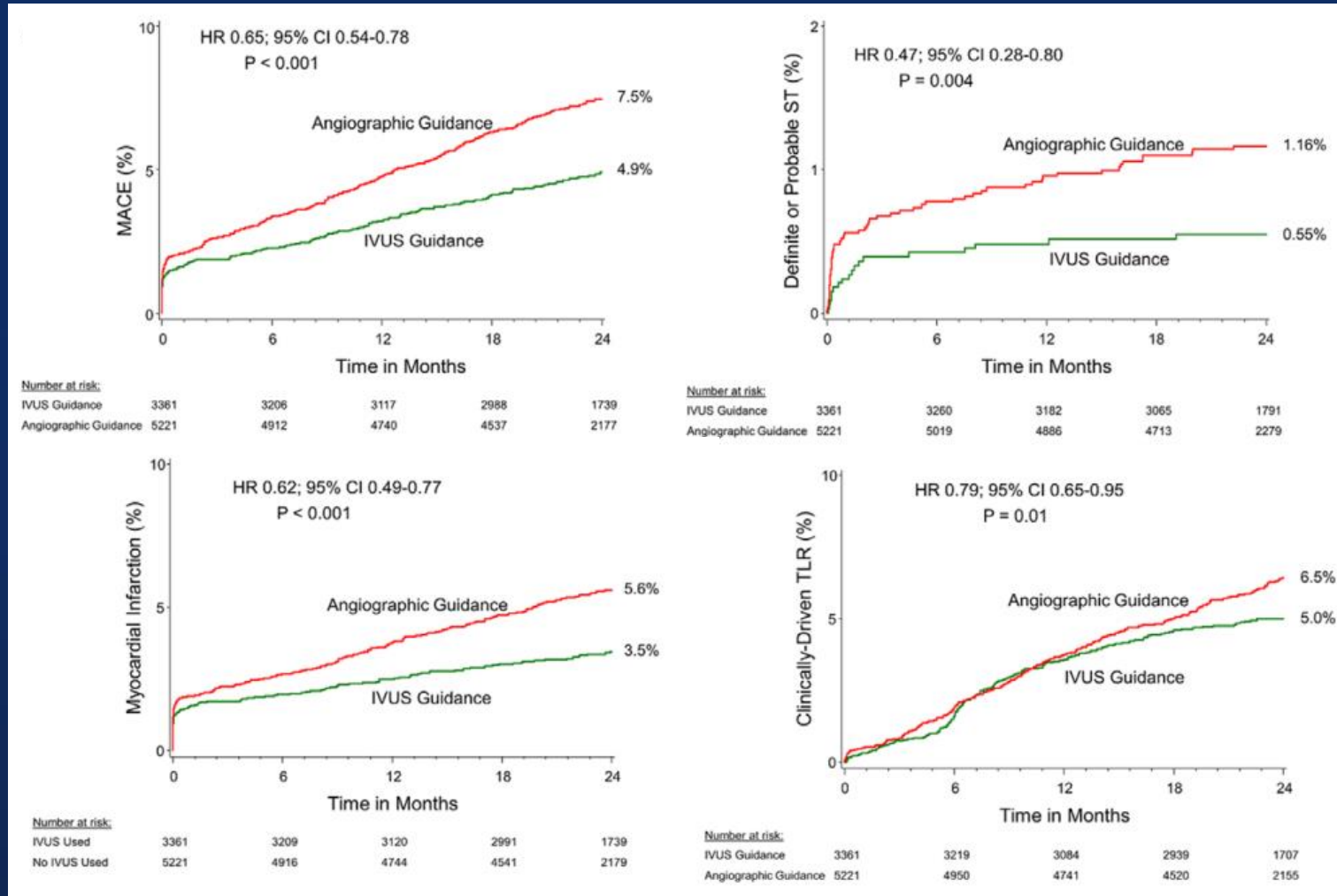

ADAPT-DES 2-years Outcomes

Landmark analysis between 1 and 2 year

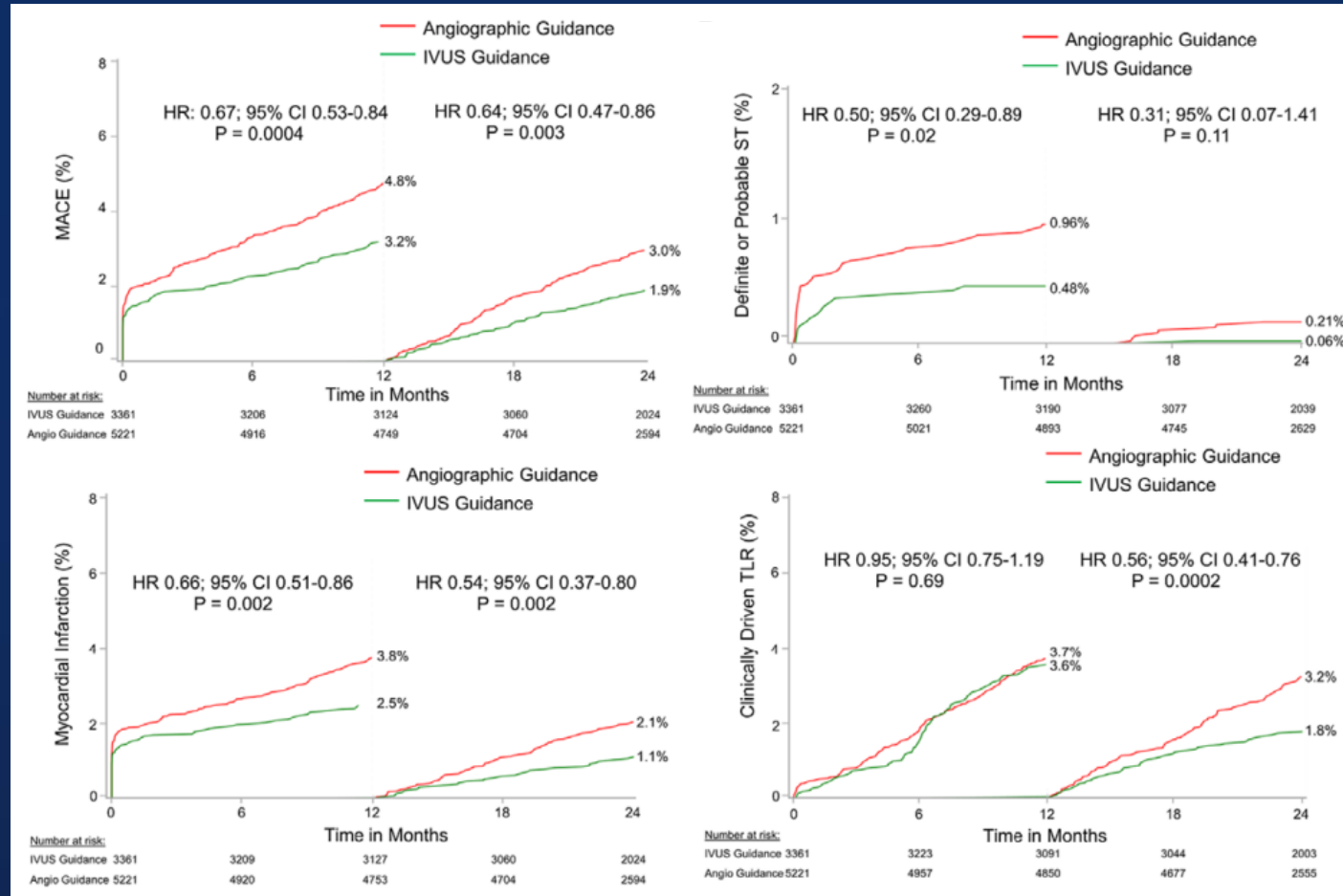

IVUS vs angio-guided DES

The ULTIMATE trial

	IVUS guidance	Angiography guidance	p value
Stent number	1.81 ± 0.80	1.76 ± 0.77	0.16
Mean stent diameter	3.14 ± 0.51	2.97 ± 0.48	<0.001
Mean stent length, mm	49.99 ± 25.10	47.38 ± 22.42	0.02
Maximum balloon diameter, mm	3.73 ± 0.56	3.51 ± 0.53	<0.001
Maximum post-dilation pressure, atm	19.7 ± 3.7	19.0 ± 3.7	<0.001

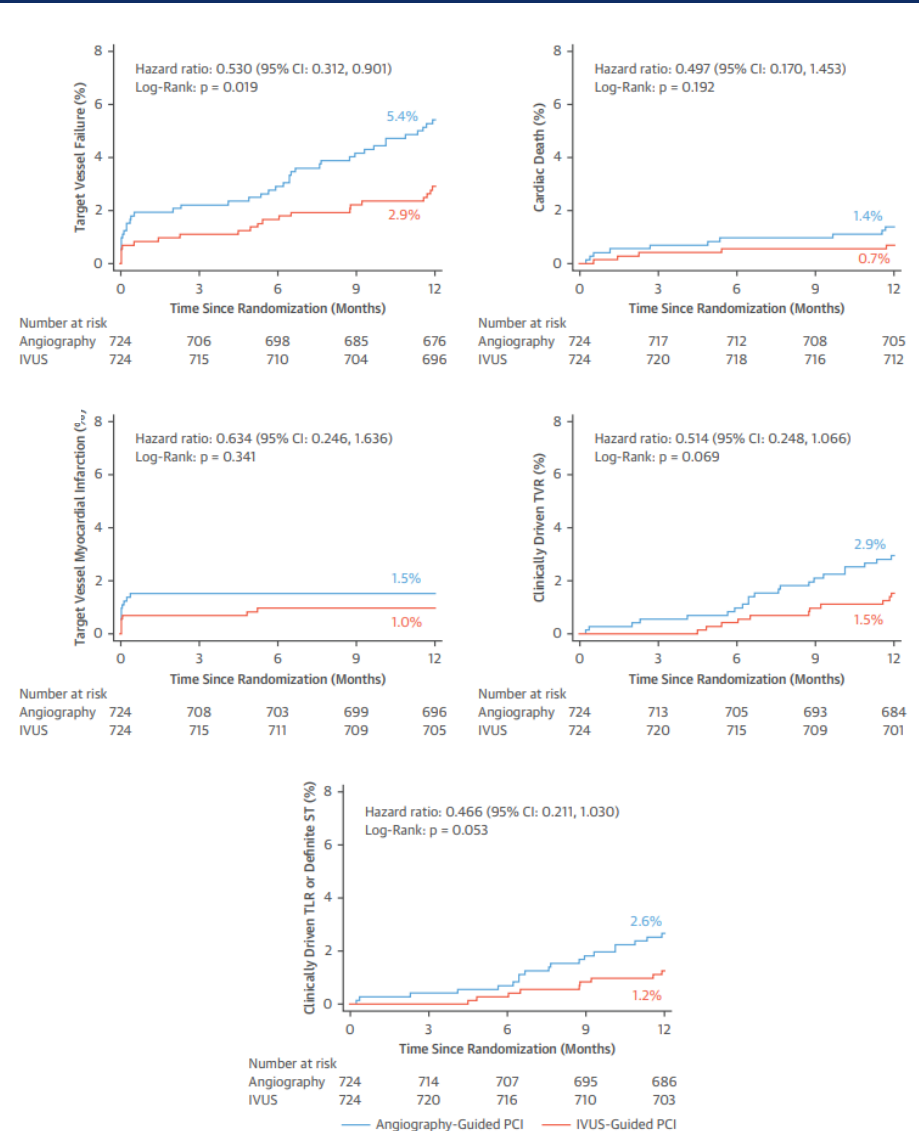

IVUS vs angio-guided DES

Meta-analysis

Study/First Author (Ref. #)	Year of Publication	Number of Patients	Study Design	Type of Stent	Follow-Up Duration (Months)
Angiography vs. IVUS					
RESIST (8)	1998	76/79	Randomized	BMS	6
CRUISE (9)	2000	229/270	Randomized	BMS	9
OPTICUS (10)	2001	275/273	Randomized	BMS	12
Gaster et al. (11)	2003	54/54	Randomized	BMS	30
TULIP (12)	2003	76/74	Randomized	BMS	6-12
DIPOL (13)	2007	80/83	Randomized	BMS	6
AVID (14)	2009	406/394	Randomized	BMS	12
HOME DES IVUS (15)	2010	105/105	Randomized	DES	18
Kim et al. (16)	2013	274/269	Randomized	DES	12
AVIO (17)	2013	142/142	Randomized	DES	24
CTO-IVUS (18)	2015	201/201	Randomized	DES	12
AIR-CTO (19)	2015	115/115	Randomized	DES	24
IVUS-XPL (20)	2015	700/700	Randomized	DES	12
Tan et al. (21)	2015	62/61	Randomized	DES	24
Roy et al. (22)	2008	884/884	Observational, PSM	DES	12
MAIN-COMPARE (23)	2009	201/201	Observational, PSM	BMS/DES	36
MATRIX (24)	2011	548/548	Observational, PSM	DES	24
Kim et al. (25)	2011	487/487	Observational, PSM	DES	36
Chen et al. (26)	2012	123/123	Observational, PSM	DES	12
Wakabayashi et al. (27)	2012	637/637	Observational, PSM	BMS/DES	12
EXCELLENT (28)	2013	463/463	Observational, PSM	DES	12
De la Torre Hernandez et al. (29)	2014	505/505	Observational, PSM	DES	36
Gao et al. (30)	2014	291/291	Observational, PSM	DES	12
Hong et al. (31)	2014	201/201	Observational, PSM	DES	24

	IVUS vs angiography
Primary endpoints	
All cause mortality	0.75 [0.58-0.98]
Secondary endpoints	
MACE	0.79 [0.67-0.91]
Cardiovascular death	0.47 [0.32-0.66]
MI	0.72 [0.52-0.93]
TLR	0.74 [0.58-0.90]
ST	0.42 [0.20-0.72]

Buccheri et al. ACC Cardiovasc Interv. 2017 Dec 26;10(24):2488-2498

IVUS-XPL Randomized Clinical Trial

Effect of IVUS-Guided vs Angiography-Guided Everolimus-Eluting Stent Implantation

- Multicenter trial
- 1400 patients with long coronary lesions (implanted stent ≥ 28 mm in length)
- 1yr follow-up
- Primary end point : MACE

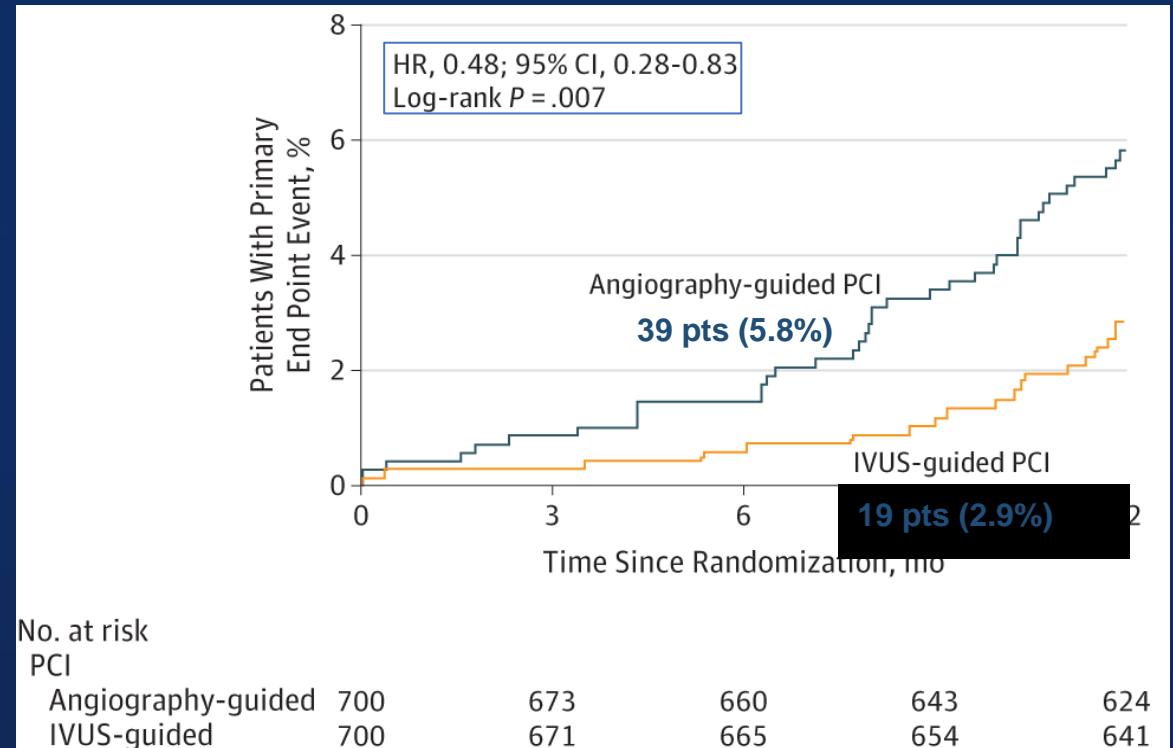

Pooled analysis

:ESTROFA-LM, RENACIMIENTO, Bellvitge, Valdecilla
Effectiveness of IVUS on LM PCI

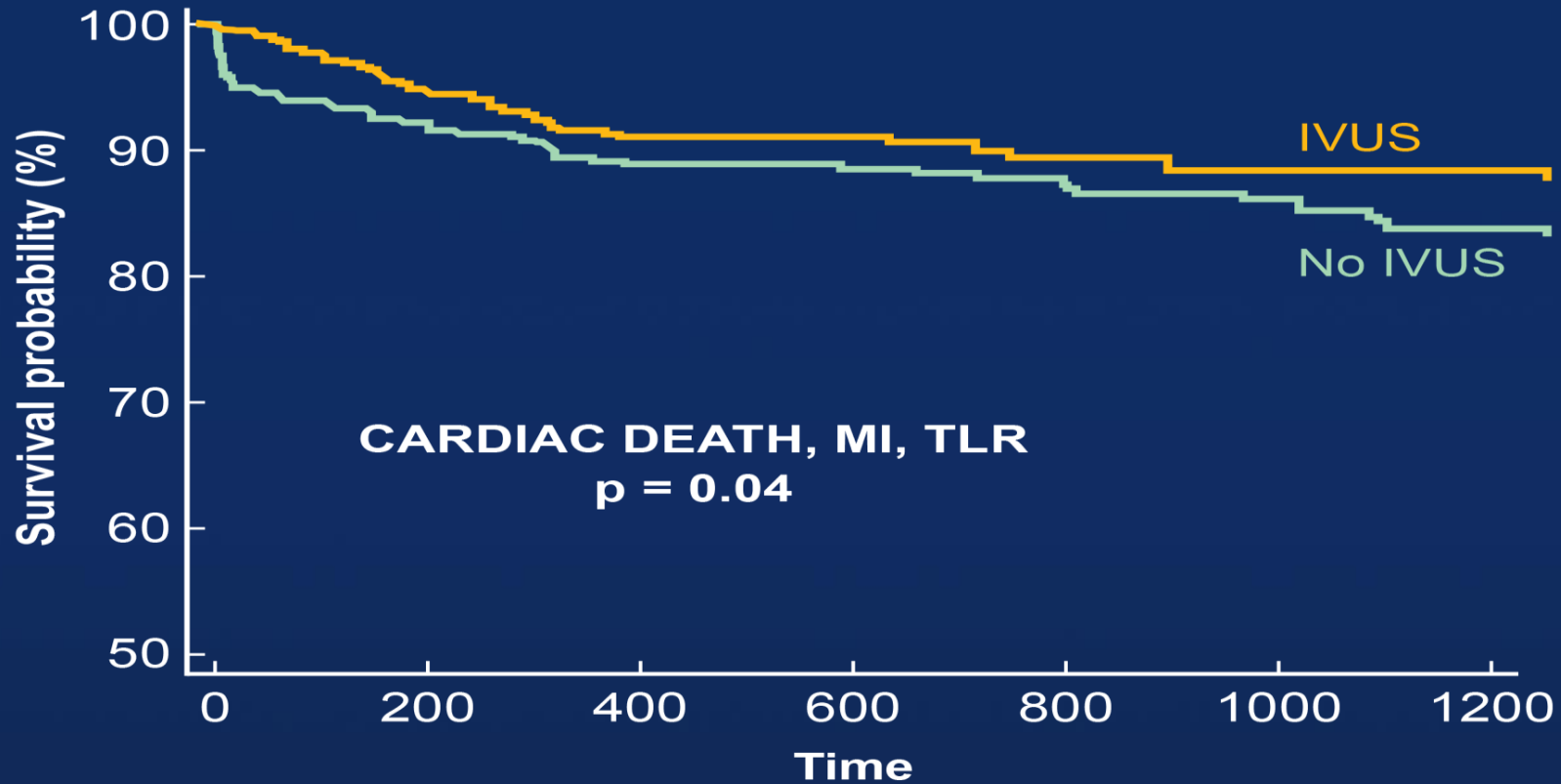

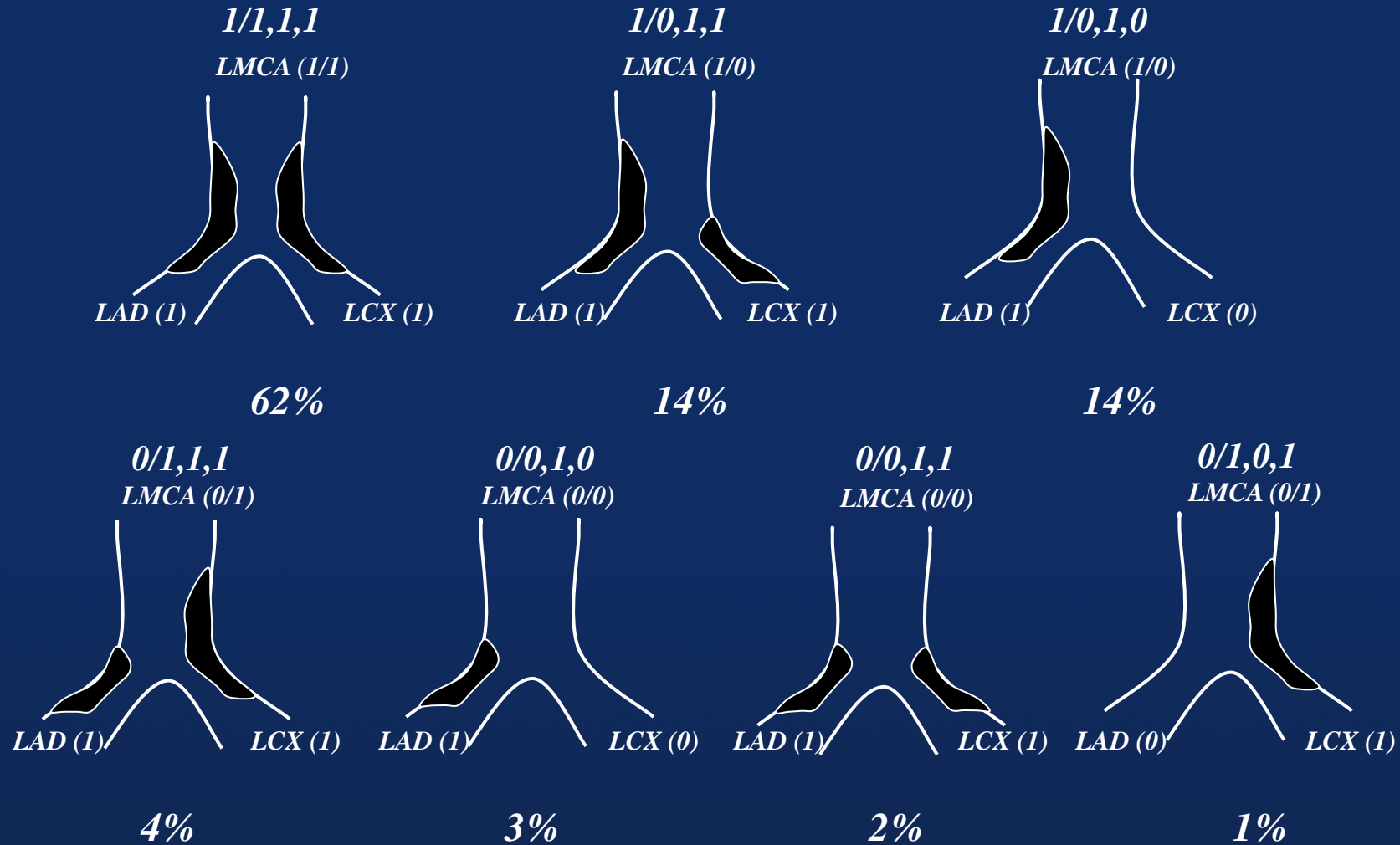

Pts. at risk	365 days	730 days	1095 days
IVUS	485	286	203
No IVUS	470	275	201

Plaque Distribution by IVUS (n=140)

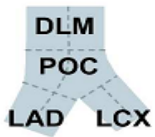
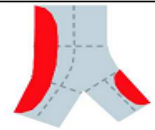
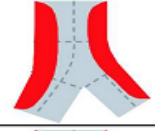
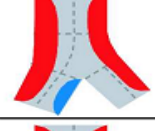
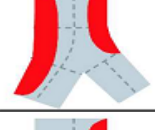
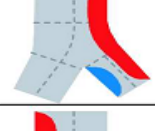
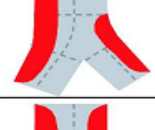
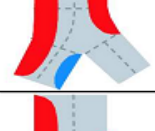

In 90% plaque extends from LMCA-LAD

Plaque Distribution by IVUS (n=82)

	N. (%)	LAD ostium, MLA (mm ²)	POC, MLA (mm ²)	DLM, MLA (mm ²)	LCX ostium, MLA (mm ²)
	5 (6%)	4.4±2.0	9.6±4.4	8.1±4.7	3.4±1.6
	26 (32%)	4.2±2.8	5.3±2.6	4.6±1.5	3.9±2.1
	12 (15%)	2.6±1.3	4.5±1.6	4.5±2.1	3.3±2.0
	9 (11%)	4.3±2.5	5.6±3.3	5.7±3.8	7.6±3.6
	9 (11%)	3.2±1.4	6.1±2.0	4.8±2.5	3.9±1.4
	4 (5%)	3.4±1.9	5.2±1.9	5.8±4.7	3.9±2.0
	4 (5%)	2.8±0.7	5.1±2.1	5.1±2.2	6.6±1.7
	5 (6%)	3.4±1.9	5.2±2.6	5.1±3.8	4.6±2.1

In all cases, the LM disease extended into LAD and LCX continuously.

Optimal MSA

on a segmental basis

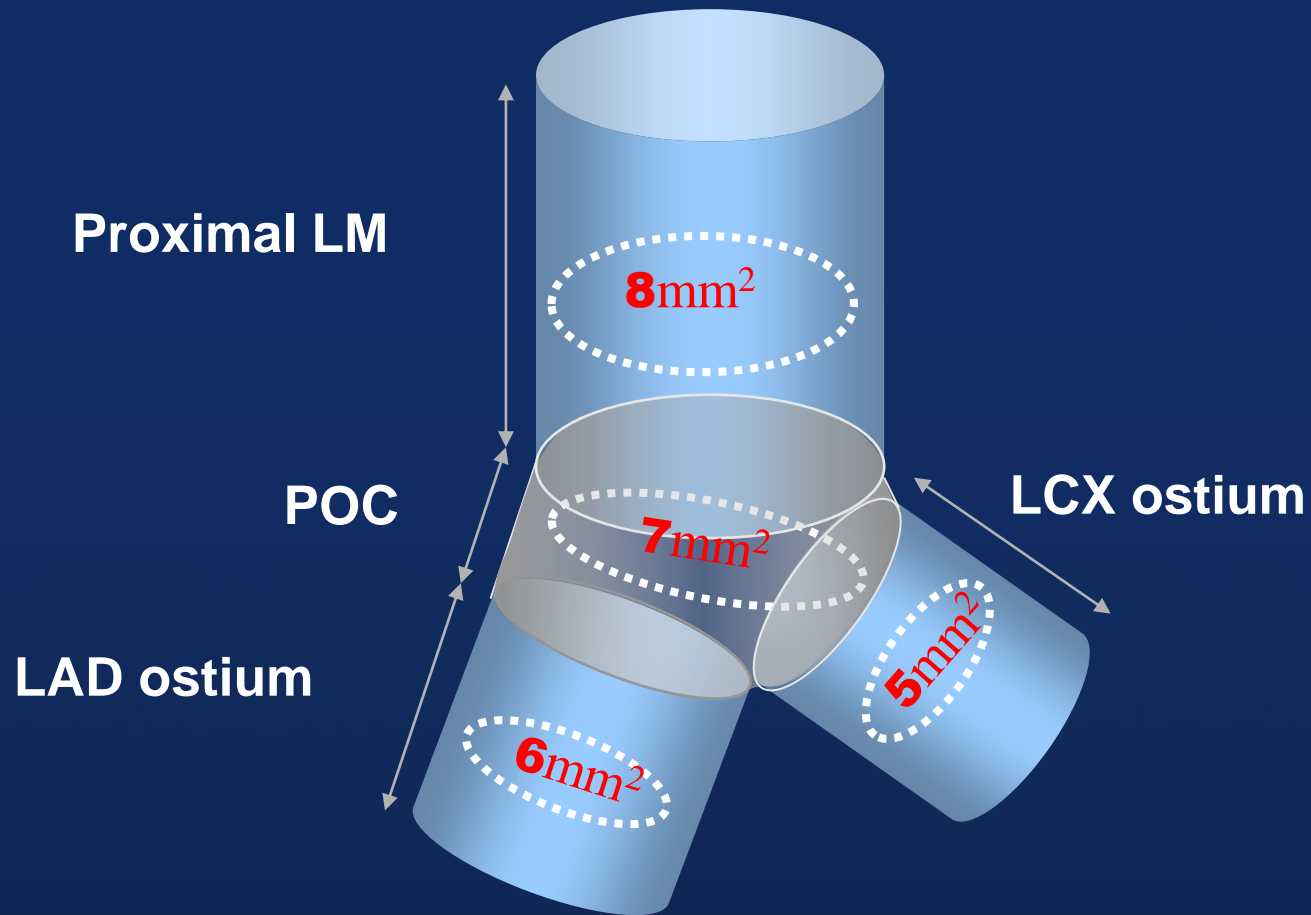

Kang et al. Circ Cardiovasc Interv 2011 2011;4:1168-74

Cut-off for Predicting LM FFR<0.75 LM MLA 6.0mm²

- Sum of lumen areas of two daughter vessels (Each of LAD and LCx should be 4.0mm²) = 150% of the parent LM
- Murray's Law ($LM\ r^3 = LAD\ r^3 + LCx\ r^3$)

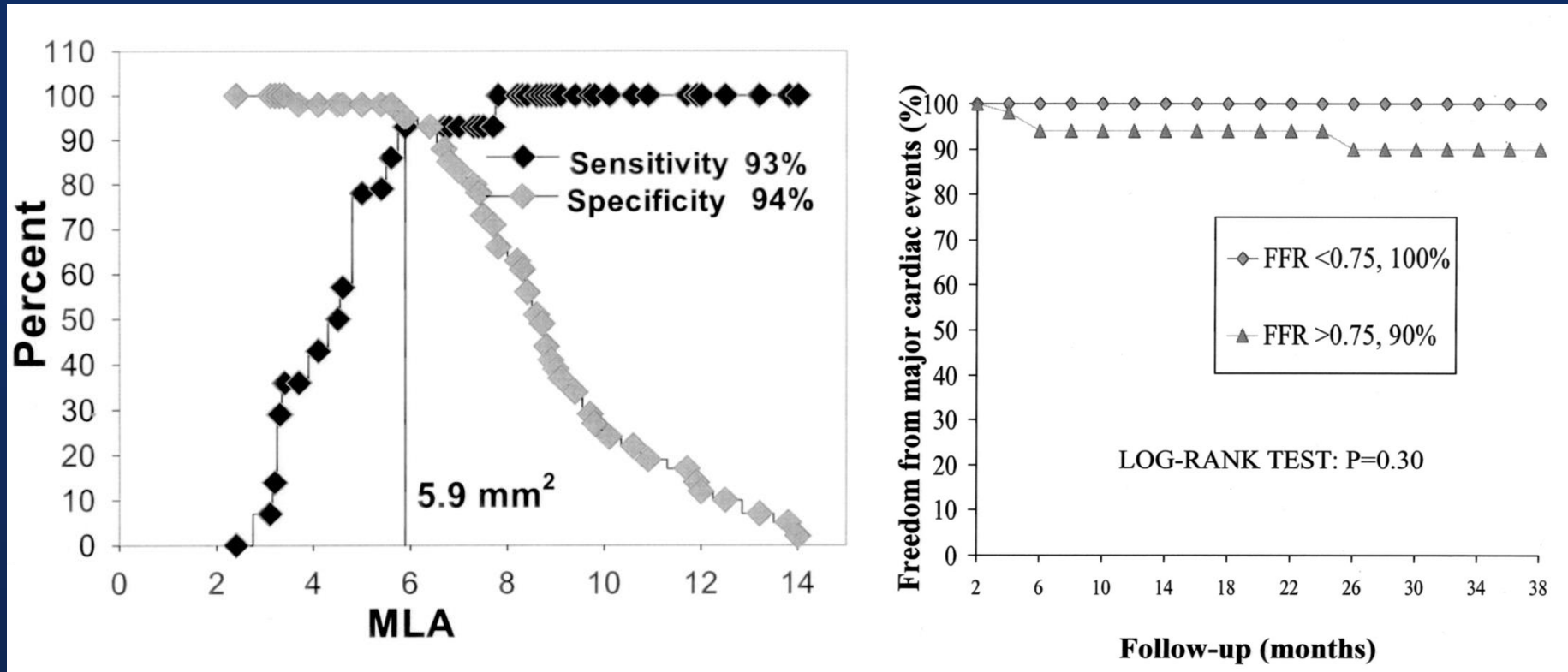

False Assumption...

The used cut-off 4.0mm² is too Big!

LAD	LCX	LM (Murray's)
3.0	3.0	4.76
3.0	2.9	4.68
3.0	2.8	4.60
3.0	2.7	4.53
3.0	2.6	4.45
3.0	2.5	4.37

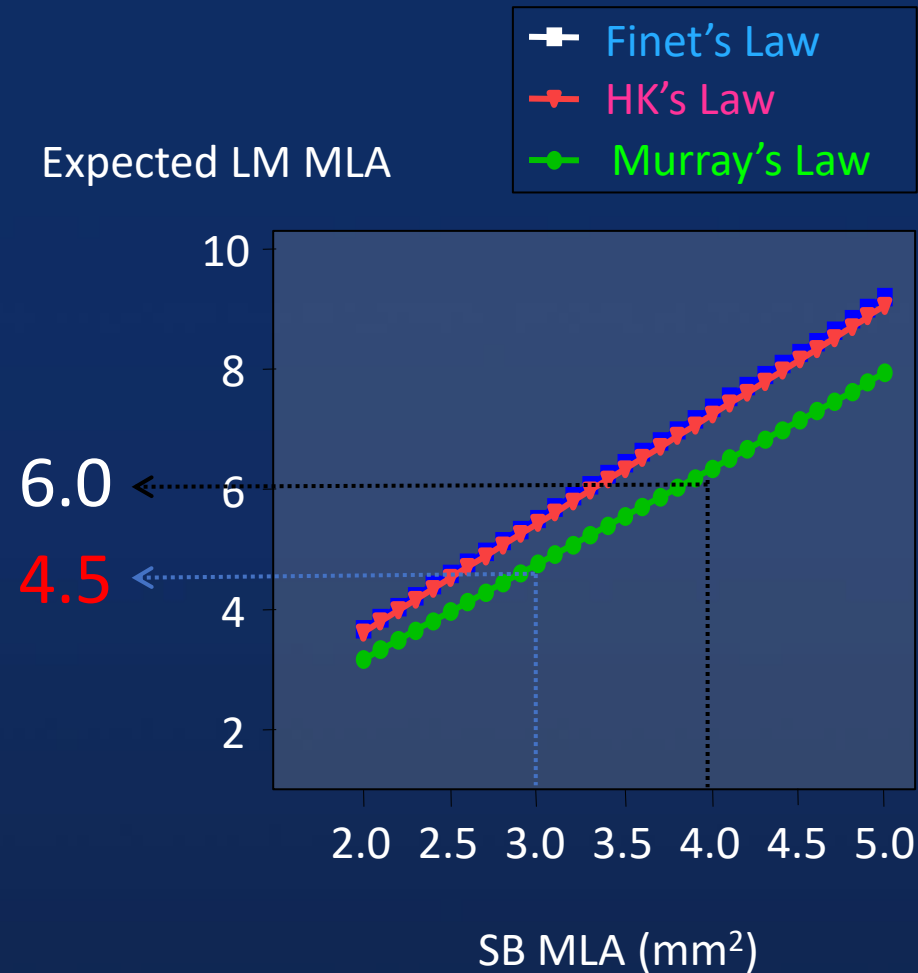

AMC New Data (n=112)

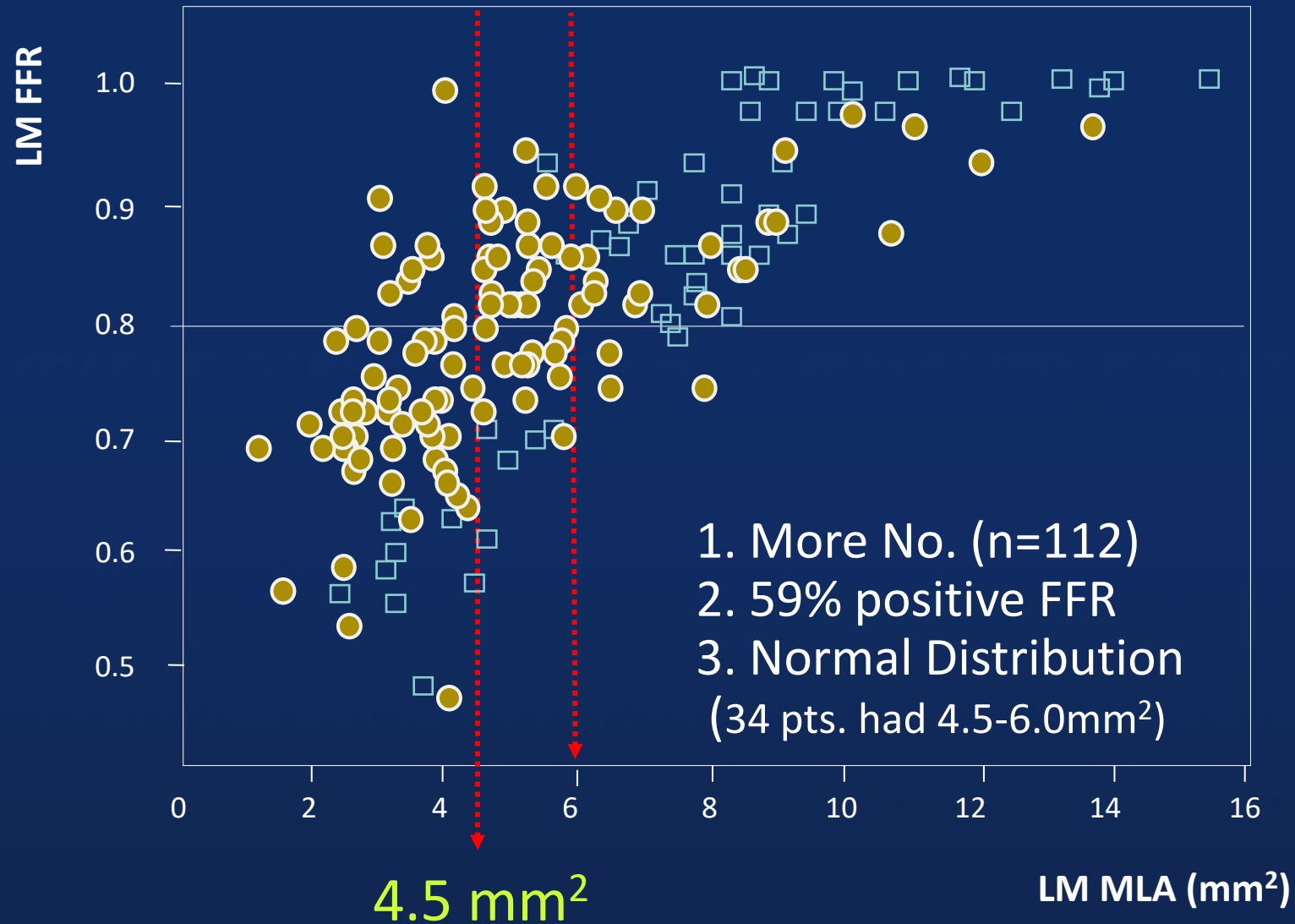

AMC New Data (n=112)

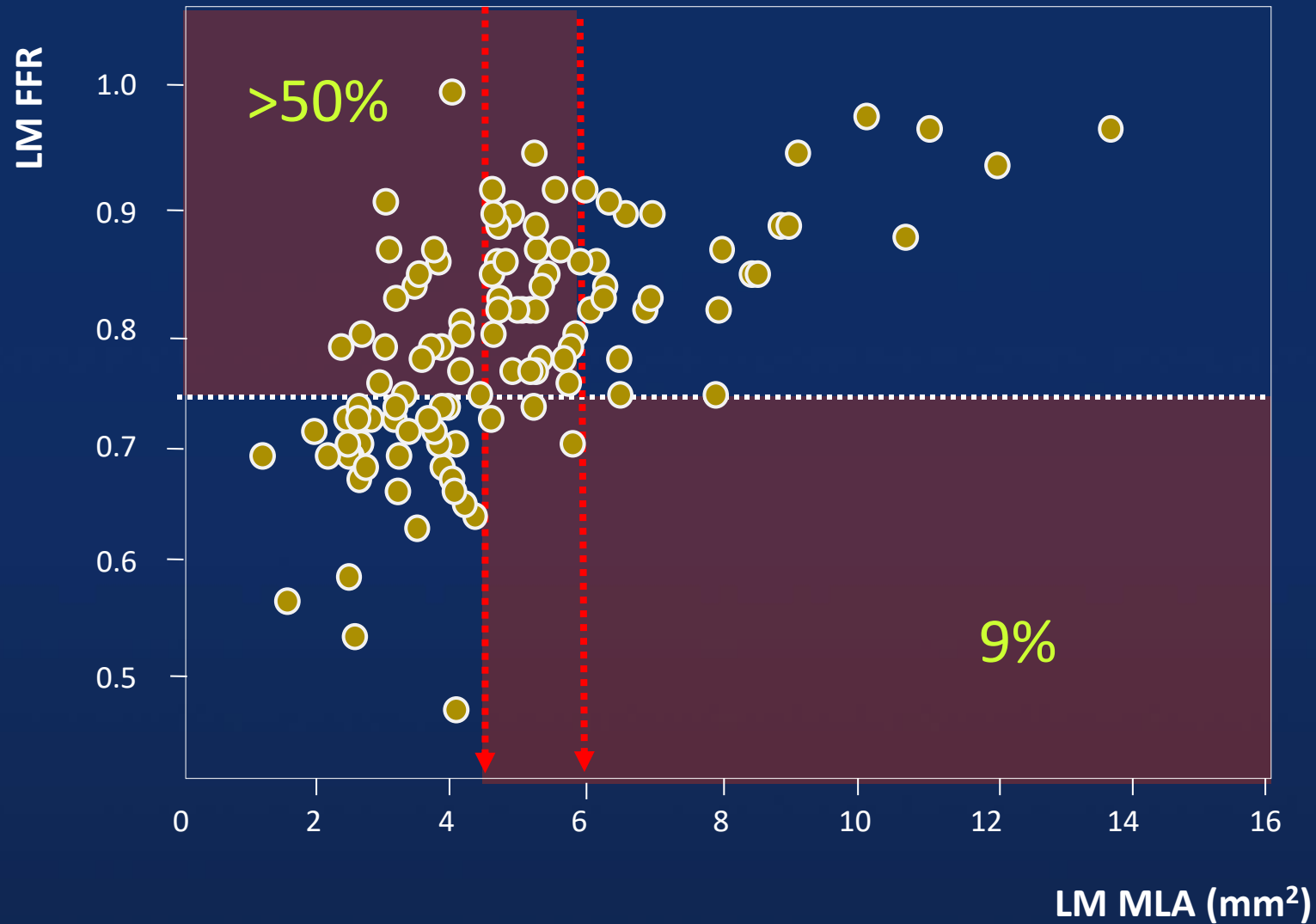

- Old data (MLA 6.0mm²) included downstream SB disease, and 32 of 55 (58%) were distal LM lesions that usually extend to the SB ostia
- Recent data (MLA 4.5mm²) evaluated only pure LM lesions, which more reliably assessed the impact of LM-MLA on functional significance

TABLE 1. Baseline Clinical, Angiographic, and IVUS Characteristics of Patients (n=55)

Age, y	62±11
Diabetes mellitus, n	20
Hypertension, n	50
Smoking, n	39
Prior bypass surgery, n	13
Ostial LM stenosis, n	20
Mid-LM stenosis, n	3
Distal LM stenosis, n	32

Jasti et al. Circulation 2004;110:2831-6

New LM MLA 4.5mm²

Matched with FFR <0.80
Ostial and Shaft LM Disease (N=112)

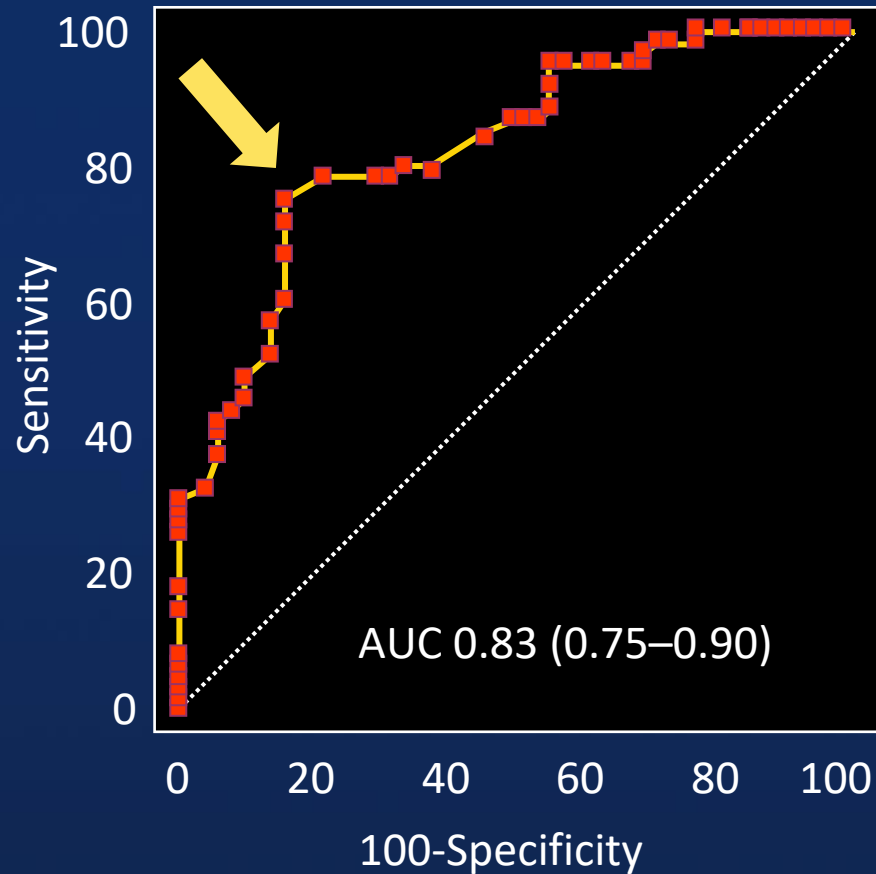

Sensitivity	79%
Specificity	80%
PPV	83%
NPV	76%

Angio-guided PCI vs. IVUS-guided PCI

Procedural Data
ULTIMATE trial

	IVUS guidance (n=962)	Angiography guidance (n=1016)	<i>P</i>
Per lesion, n (%)			
Stent number	1.81±0.80	1.76±0.77	0.16
Mean stent length, mm	49.99±25.10	47.38±22.42	0.02
Mean stent diameter, mm	3.14±0.51	2.97±0.48	<0.001
Max balloon diameter, mm	3.73±0.56	3.51±0.53	<0.001
Max post-dilation pressure, atm	19.7±3.7	19.0±3.7	<0.001

Angio-guided PCI vs. IVUS-guided PCI

TVF at 12-months
ULTIMATE trial

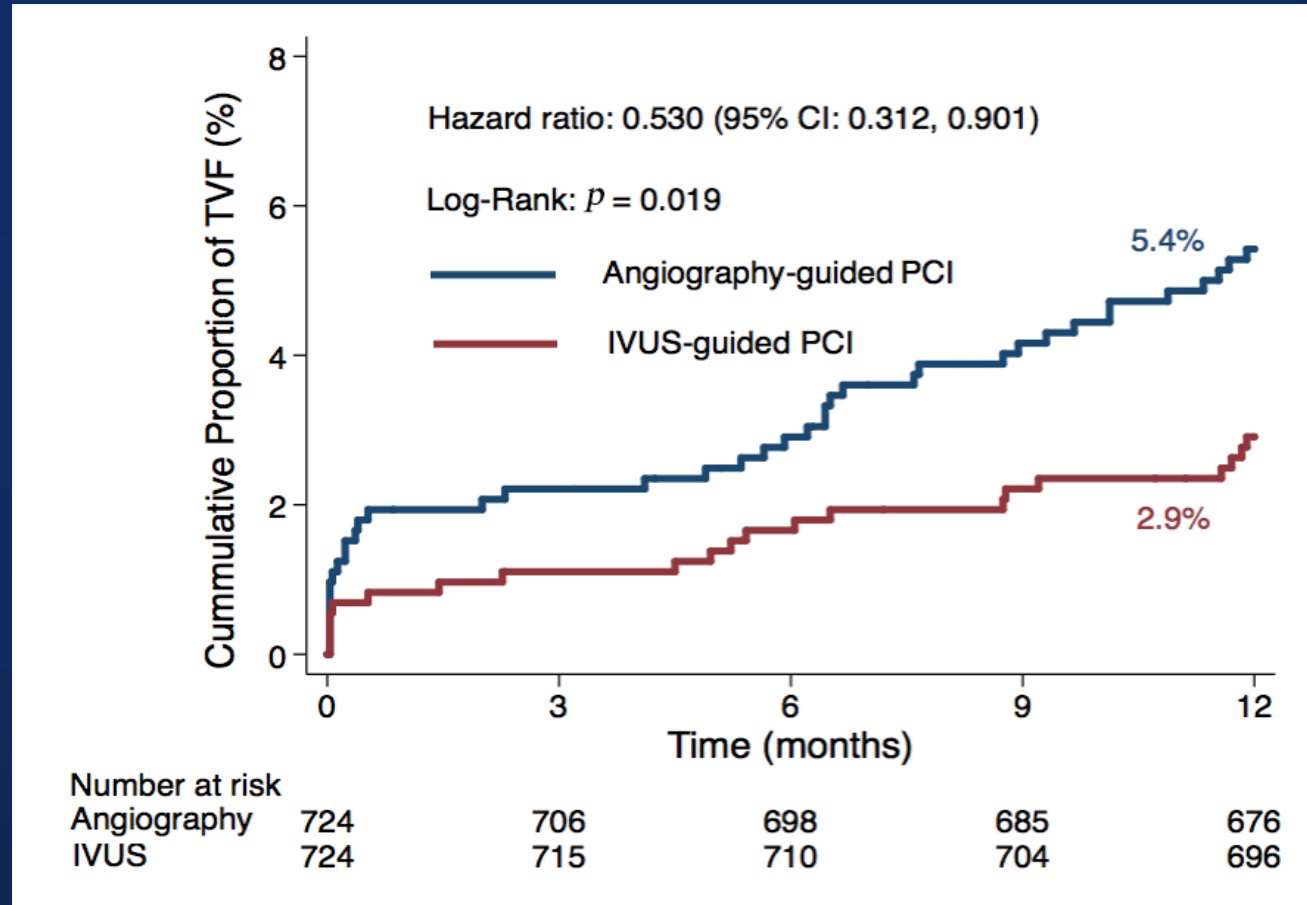

Angio-guided PCI vs. IVUS-guided PCI

CD-TLR or Definite ST at 12-month
ULTIMATE trial

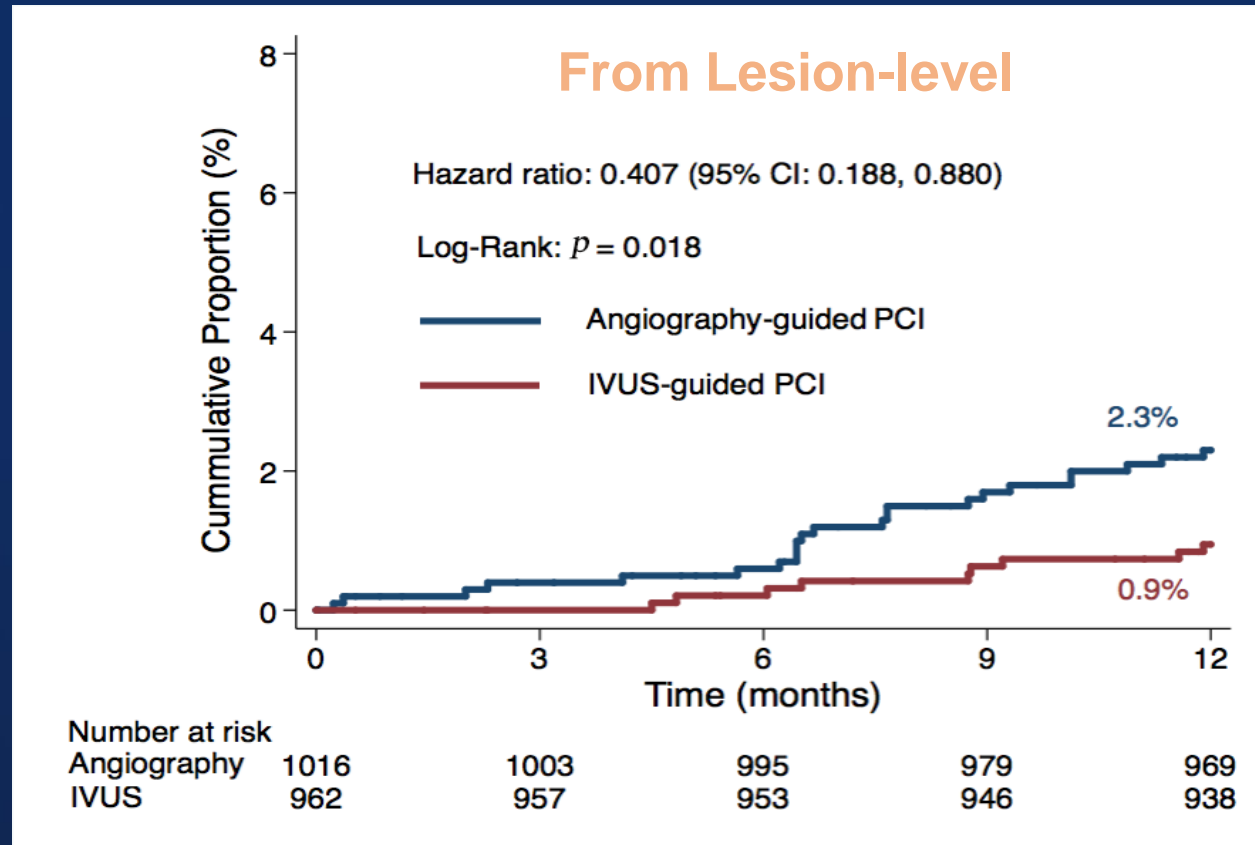

On-site Post-procedure IVUS Assessment

ULTIMATE trial

	Optimal group	Suboptimal group	<i>P</i>
Number of patients, n (%)	384 (53.0)	340 (47.0)	
Number of lesions, n (%)	578 (60.1)	384 (39.9)	
MSA, mm ²	6.09	5.45	<0.001
Prox. edge plaque burden	37.2%	51.2%	<0.001
Dist. edge plaque burden	24.2%	35.1%	<0.001

Optimal vs. Suboptimal IVUS-guided PCI

TVF at 12-months
ULTIMATE trial

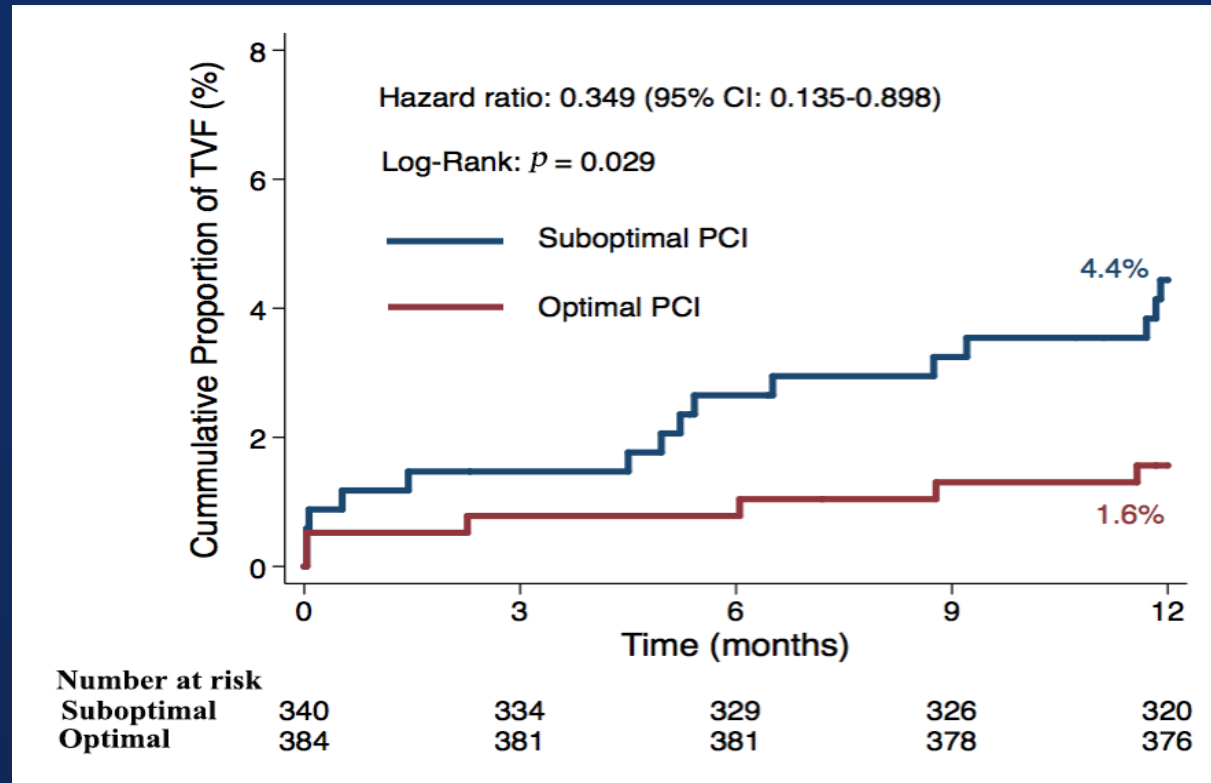

ULTIMATE 3-Year Outcomes

Target vessel failure

Cardiac death

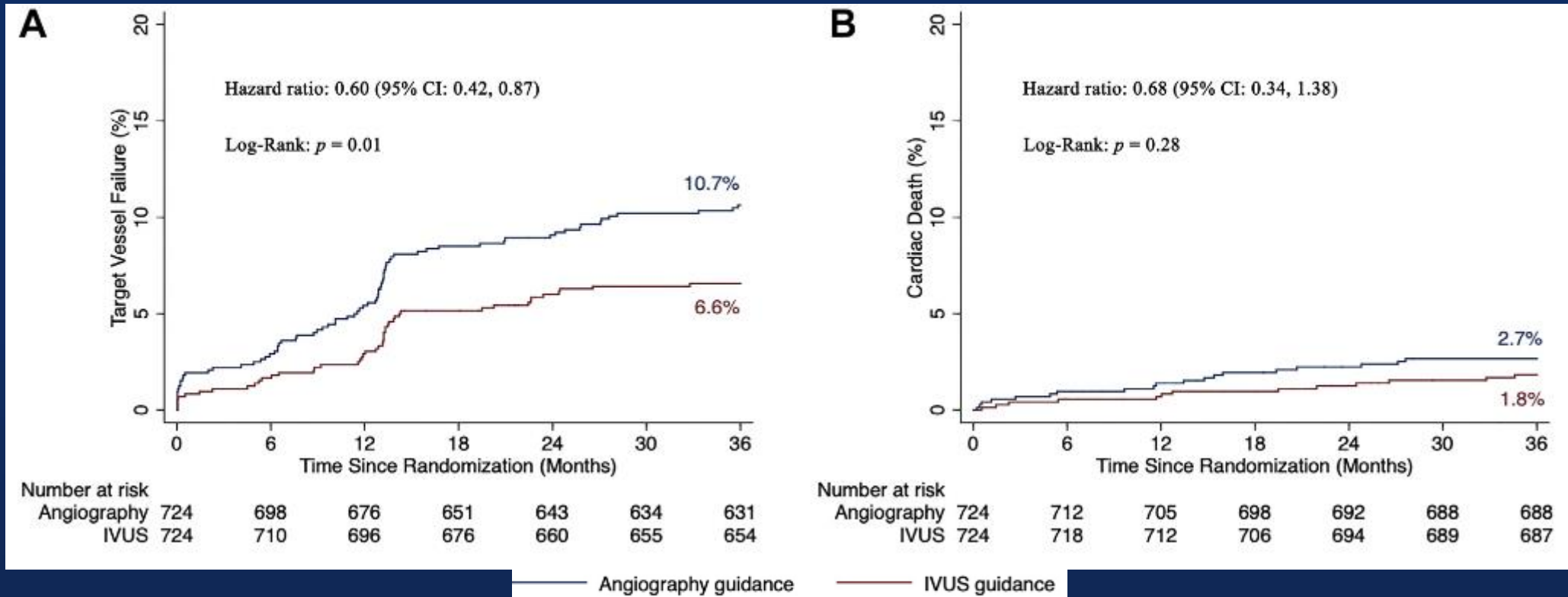

ULTIMATE 3-Year Outcomes

Target vessel MI

Clinically driven TVR

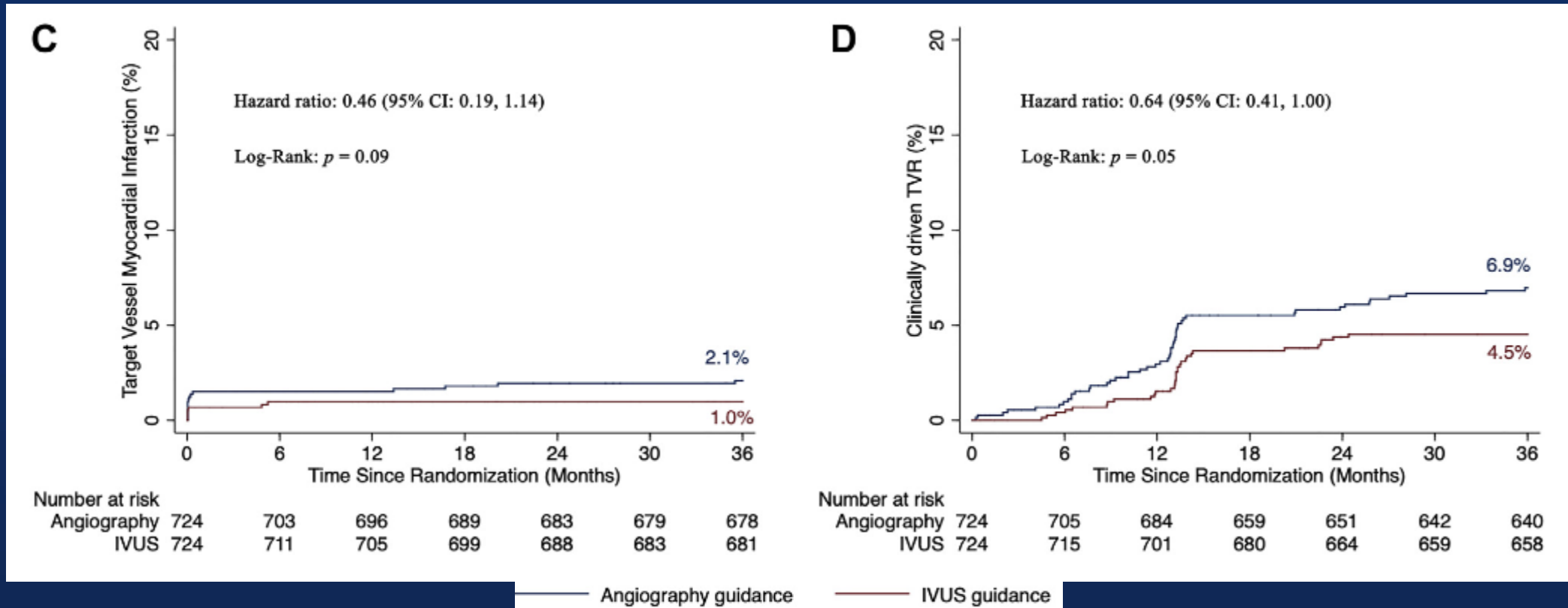

RENOVATE-COMPLEX PCI

Prospective, multicenter, open label trial

1639 Complex CAD Patients

R
2:1

```
graph TD; A[1639 Complex CAD Patients] --> B((R 2:1)); B --> C[Image Guided PCI (IVUS/OCT) (n=1092)]; B --> D[Angio Guided PCI (n=547)];
```

Image Guided PCI (IVUS/OCT)
(n=1092)

Angio Guided PCI
(n=547)

Primary Endpoint at 3 year:

Target vessel Failure = Composite Death from Cardiac cause, TVR myocardial infarction or revascularization

RENOVATE-COMPLEX PCI

A Target-Vessel Failure

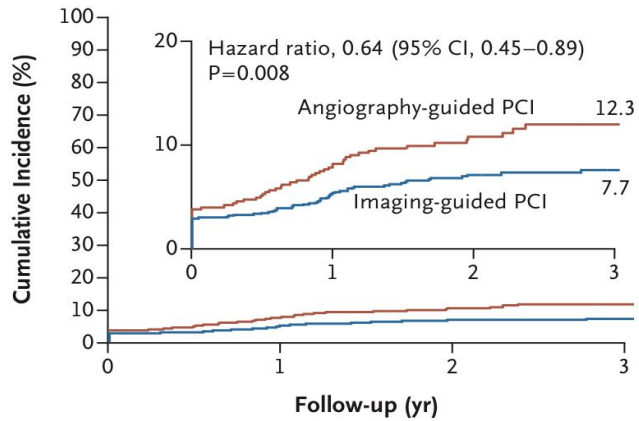

No. at Risk

	0	1	2	3
Angiography-guided PCI	547	496	280	120
Imaging-guided PCI	1092	1023	591	255

B Target-Vessel Failure without Procedure-Related Myocardial Infarction

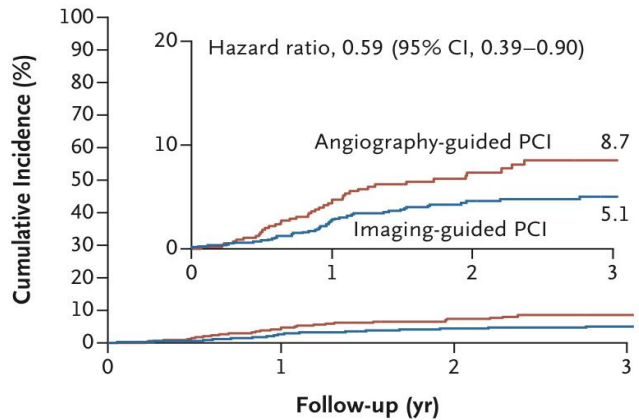

No. at Risk

	0	1	2	3
Angiography-guided PCI	547	516	284	121
Imaging-guided PCI	1092	1051	596	256

Subgroup	Intravascular Imaging-Guided PCI no. of events/total no. of patients (cumulative incidence, %)	Angiography-Guided PCI no. of events/total no. of patients (cumulative incidence, %)	Hazard Ratio (95% CI)
Overall	76/1092 (7.7)	60/547 (12.3)	0.64 (0.45-0.89)
Type of imaging devices			
Intravascular ultrasonography	59/800 (8.0)	60/547 (12.3)	0.66 (0.46-0.95)
Optical coherence tomography	15/278 (5.8)	60/547 (12.3)	0.47 (0.27-0.83)
Type of complex coronary lesions			
True bifurcation	23/233 (10.3)	13/126 (11.8)	0.97 (0.49-1.93)
Chronic total occlusion	9/220 (5.0)	13/99 (14)	0.30 (0.13-0.71)
Unprotected left main coronary artery disease	9/138 (6.8)	11/54 (25)	0.31 (0.13-0.76)
Diffuse long coronary-artery lesion	36/617 (6.5)	31/281 (11.9)	0.52 (0.32-0.83)
Multivessel PCI involving ≥2 major coronary arteries	36/409 (9.5)	22/213 (11.7)	0.84 (0.50-1.44)
Lesion necessitating use of ≥3 stents	16/208 (8.1)	6/97 (6)	1.24 (0.49-3.18)
Lesion with in-stent restenosis	22/158 (15.6)	12/78 (17)	0.90 (0.45-1.82)
Severely calcified lesion	11/157 (7.3)	11/74 (17)	0.46 (0.20-1.06)
Ostial lesions of major coronary artery	8/182 (4.4)	9/69 (16)	0.33 (0.13-0.85)
Initial presentation			
Stable ischemic heart disease	25/532 (5.0)	27/275 (10.4)	0.46 (0.27-0.80)
Acute coronary syndrome	51/560 (10.4)	33/272 (14.6)	0.74 (0.48-1.15)
Age			
<65 yr	36/517 (7.8)	23/238 (10.6)	0.72 (0.42-1.21)
≥65 yr	40/575 (7.4)	37/309 (13.6)	0.57 (0.36-0.88)
Sex			
Male	66/869 (8.3)	46/431 (11.7)	0.70 (0.48-1.02)
Female	10/223 (5.2)	14/116 (14.5)	0.35 (0.16-0.80)
Diabetes mellitus			
Yes	45/394 (12.9)	26/223 (12.3)	0.97 (0.60-1.57)
No	31/698 (4.7)	34/324 (12.2)	0.41 (0.25-0.67)
Chronic kidney disease			
Yes	22/203 (13.3)	19/93 (23)	0.51 (0.27-0.93)
No	54/889 (6.4)	41/454 (9.9)	0.66 (0.44-0.99)
Left ventricular ejection fraction			
<50%	22/210 (12.0)	12/84 (15)	0.72 (0.35-1.45)
≥50%	54/882 (6.7)	48/463 (11.8)	0.58 (0.39-0.85)

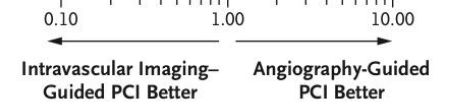

Angio-guided PCI vs. IVUS-guided PCI

Meta-analysis

Study/First Author (Ref. #)	Year of Publication	Number of Patients	Study Design	Type of Stent	Follow-Up Duration (Months)
Angiography vs. IVUS					
RESIST (8)	1998	76/79	Randomized	BMS	6
CRUISE (9)	2000	229/270	Randomized	BMS	9
OPTICUS (10)	2001	275/273	Randomized	BMS	12
Gaster et al. (11)	2003	54/54	Randomized	BMS	30
TULIP (12)	2003	76/74	Randomized	BMS	6-12
DIPOL (13)	2007	80/83	Randomized	BMS	6
AVID (14)	2009	406/394	Randomized	BMS	12
HOME DES IVUS (15)	2010	105/105	Randomized	DES	18
Kim et al. (16)	2013	274/269	Randomized	DES	12
AVIO (17)	2013	142/142	Randomized	DES	24
CTO-IVUS (18)	2015	201/201	Randomized	DES	12
AIR-CTO (19)	2015	115/115	Randomized	DES	24
IVUS-XPL (20)	2015	700/700	Randomized	DES	12
Tan et al. (21)	2015	62/61	Randomized	DES	24
Roy et al. (22)	2008	884/884	Observational, PSM	DES	12
MAIN-COMPARE (23)	2009	201/201	Observational, PSM	BMS/DES	36
MATRIX (24)	2011	548/548	Observational, PSM	DES	24
Kim et al. (25)	2011	487/487	Observational, PSM	DES	36
Chen et al. (26)	2012	123/123	Observational, PSM	DES	12
Wakabayashi et al. (27)	2012	637/637	Observational, PSM	BMS/DES	12
EXCELLENT (28)	2013	463/463	Observational, PSM	DES	12
De la Torre Hernandez et al. (29)	2014	505/505	Observational, PSM	DES	36
Gao et al. (30)	2014	291/291	Observational, PSM	DES	12
Hong et al. (31)	2014	201/201	Observational, PSM	DES	24

IVUS compared with
angiography
Odds ratio [95% CI]

Primary outcome

All cause mortality 0.75 [0.58-0.98]

Secondary outcome

MACE 0.79 [0.67-0.91]

Cardiovascular death 0.47 [0.32-0.66]

MI 0.72 [0.52-0.93]

TLR 0.74 [0.58-0.90]

ST 0.42 [0.20-0.72]

*Buccheri et al. JACC Cardiovasc Interv. 2017 Dec
26;10(24):2488-2498*

VH-IVUS

Fibrous Tissue

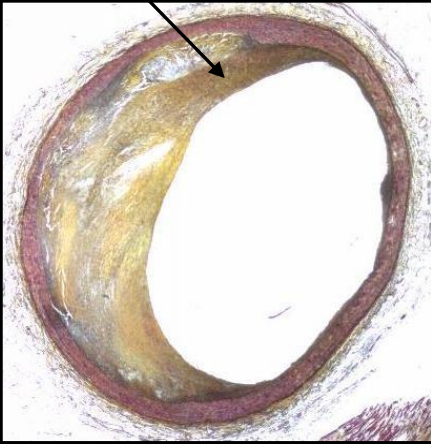

Densely packed collagen fibers with no evidence of lipid accumulation. No evidence of macrophage infiltration.

Necrotic Core

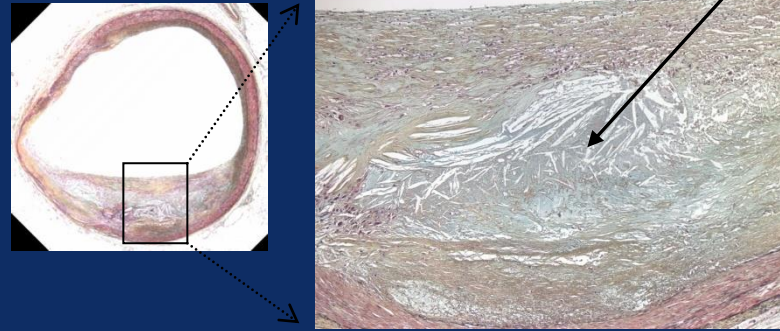

Highly lipidic necrotic region with remnants of foam cells and dead lymphocytes. No collagen fiber, Cholesterol clefts and micro calcifications

Fibro-Fatty



Loosely packed bundles of collagen fibers with regions of lipid deposition present. No cholesterol clefts or necrosis. Increase in extra-cellular matrix

Dense Calcium

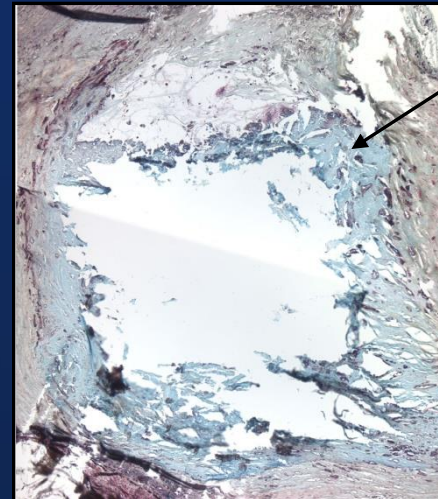

Focal dense calcium

PIT

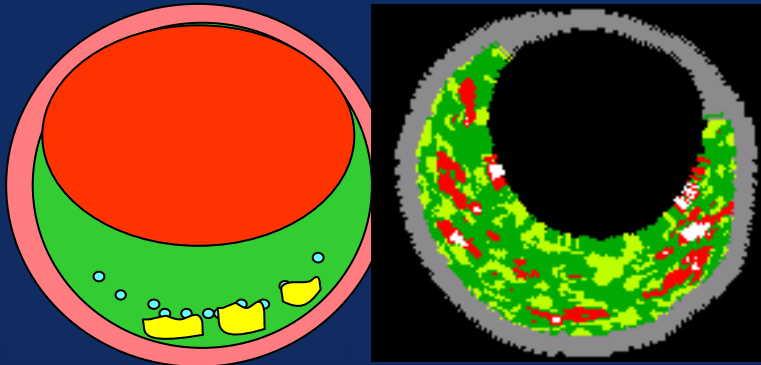

Plaque thickness > 600um
Fibrofatty >15%

Fibroatheroma

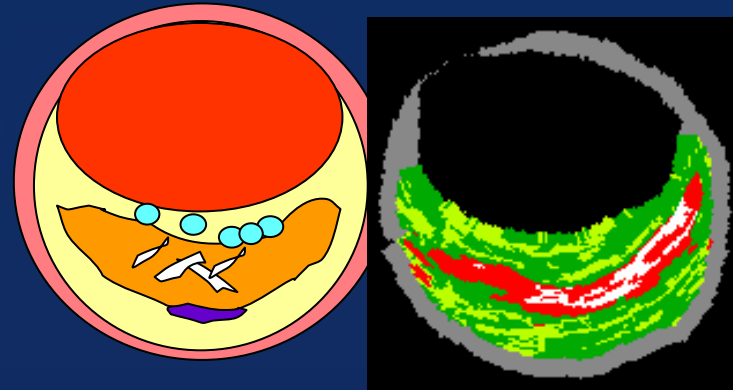

Confluent NC >10%

Criteria of TCFA

In at least 3 consecutive frames:

- 1) Necrotic core $\geq 10\%$
- 2) without evident overlying fibrous tissue
- 3) Percent atheroma area $\geq 40\%$

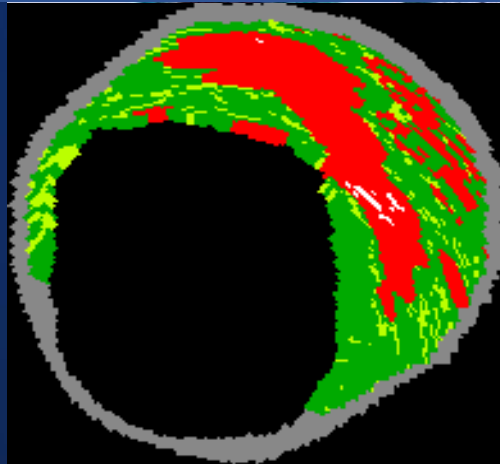

Thick fibrous cap
Low lipid conc
Low macrophage density

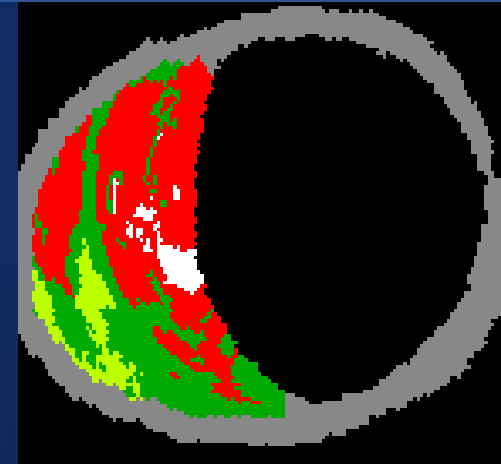

Thin fibrous cap
High lipid conc
High macrophage density

Change of Plaque Type

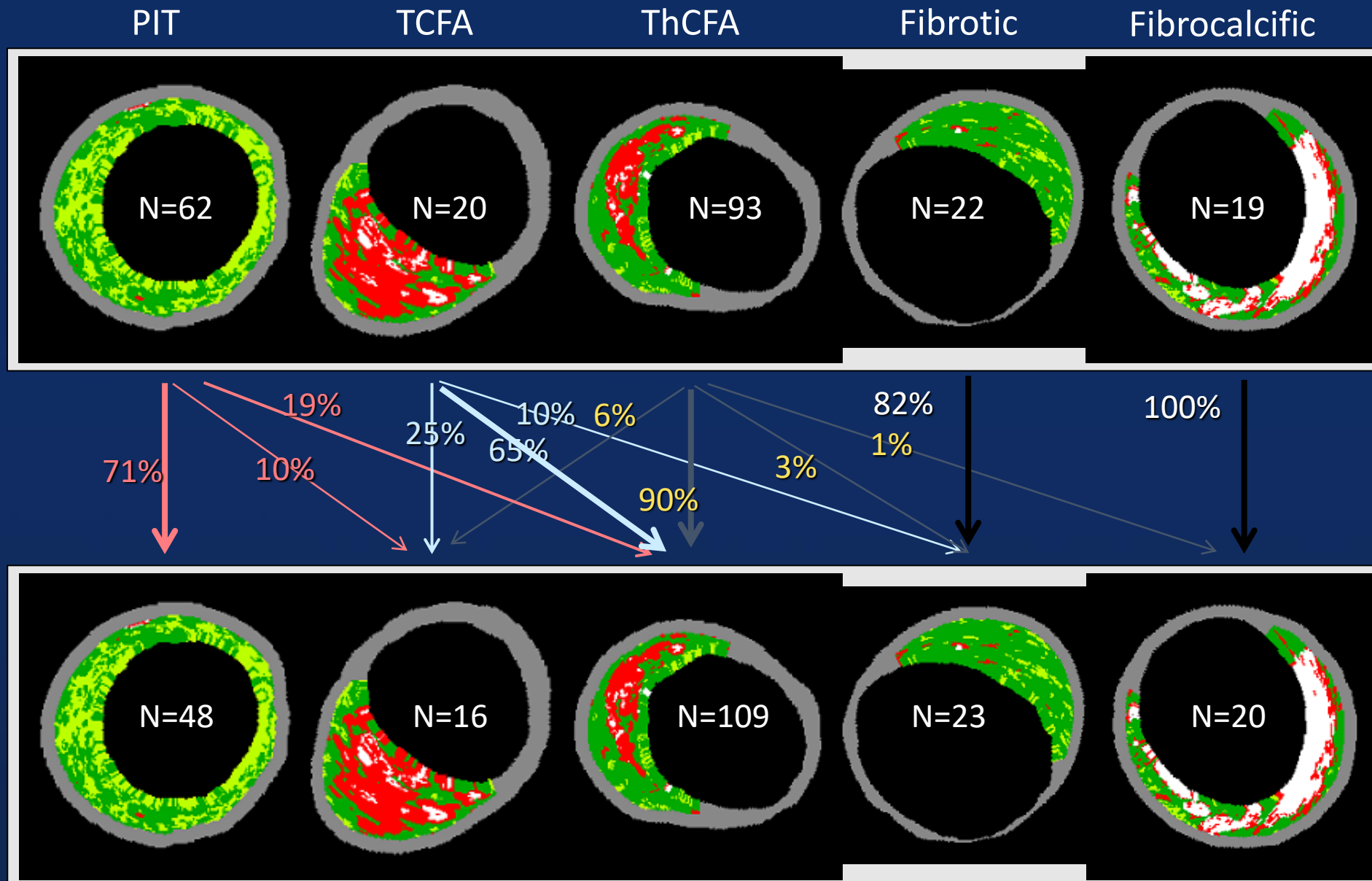

Differences in Temporal Changes of Non-Culprit Lesions

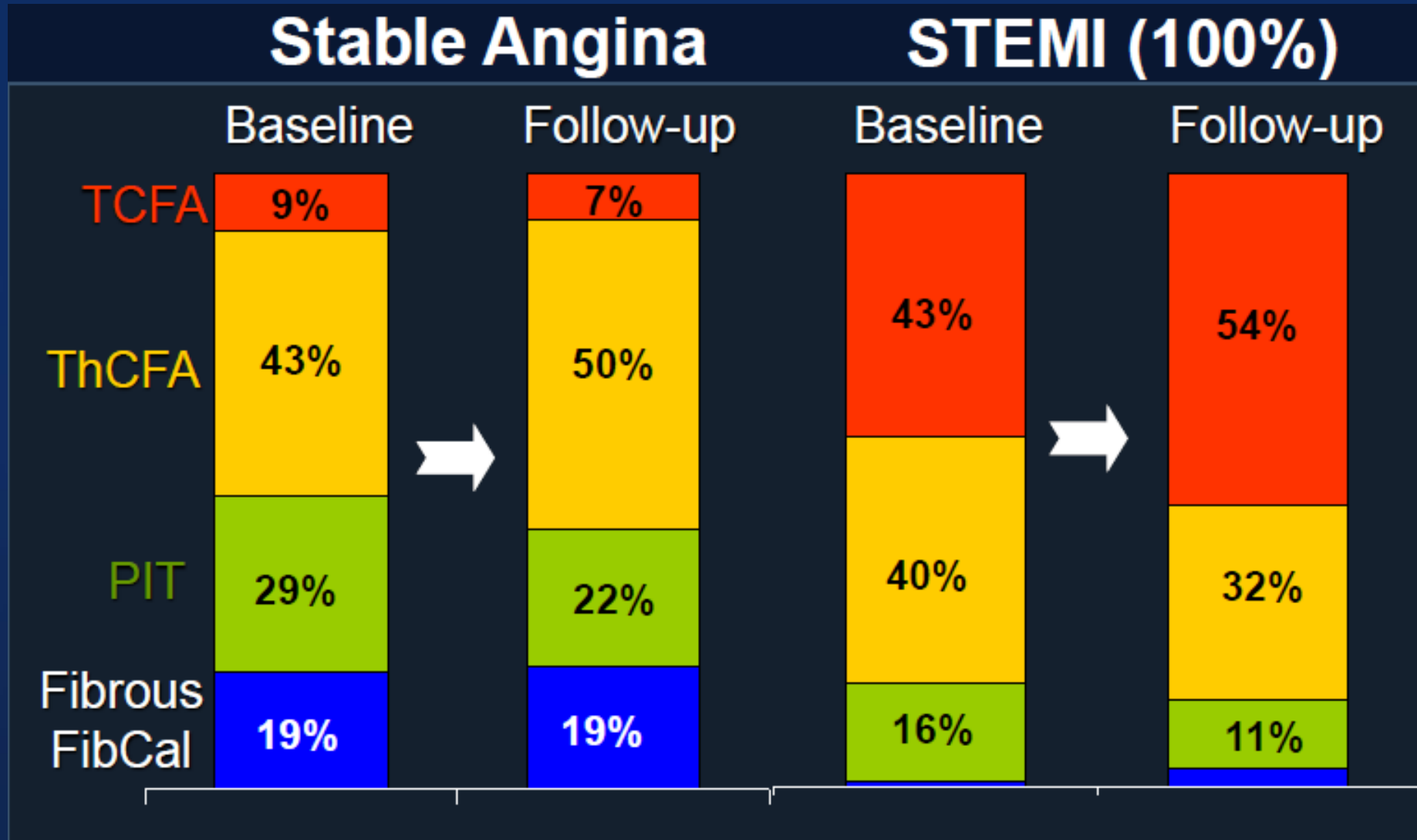

PROSPECT MACE (N=697)

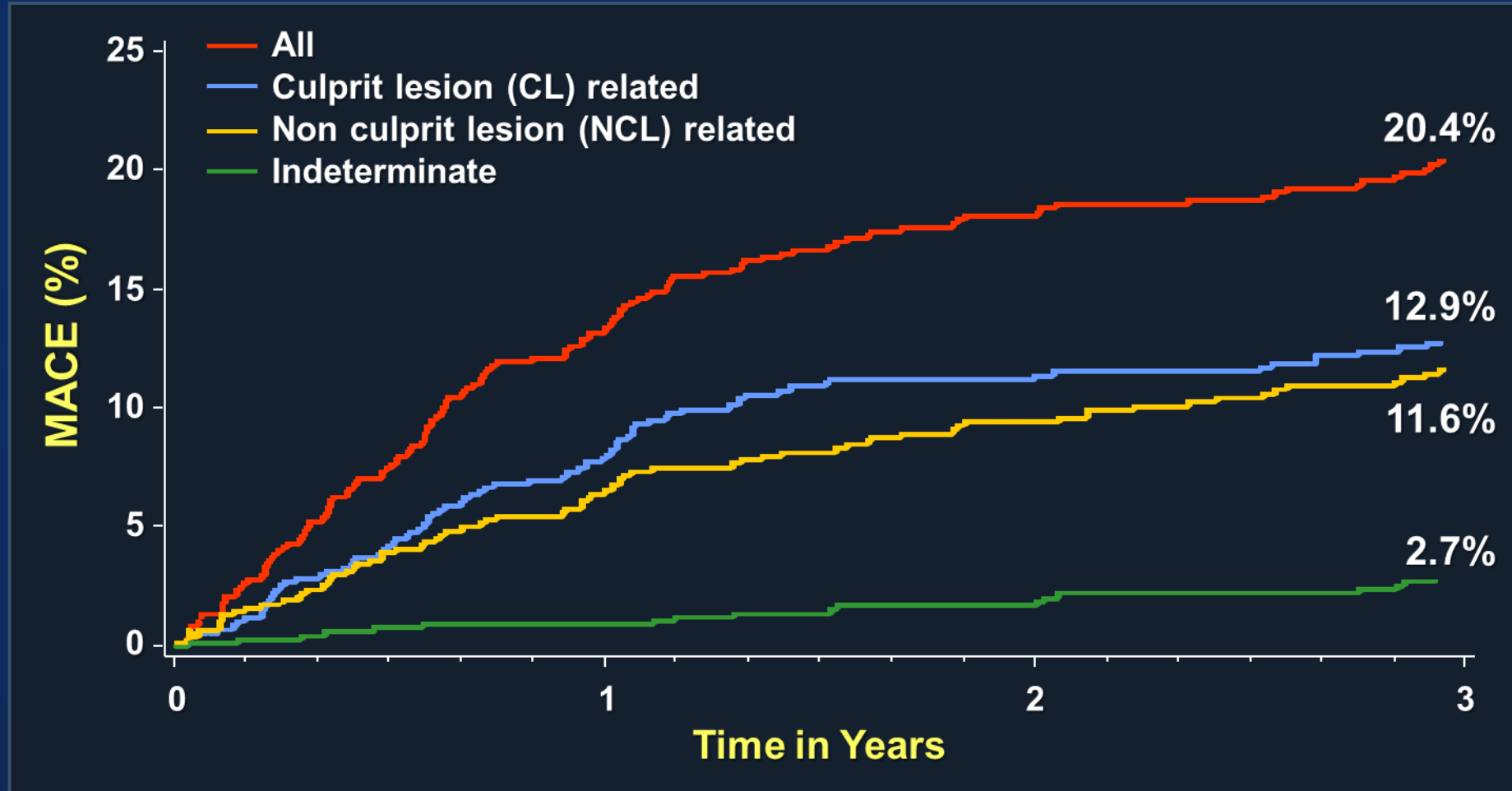
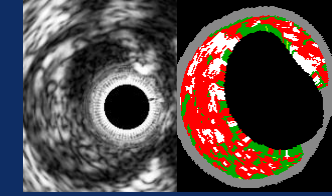
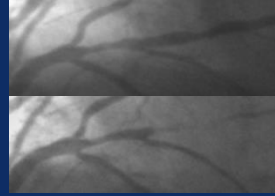

Number at risk

ALL	697	557	506	480
CL related	697	590	543	518
NCL related	697	595	553	521
Indeterminate	697	634	604	583

PROSPECT 3-year MACE

*MACE = cardiac death, arrest, MI, rehospitalization for unstable/ progressive angina

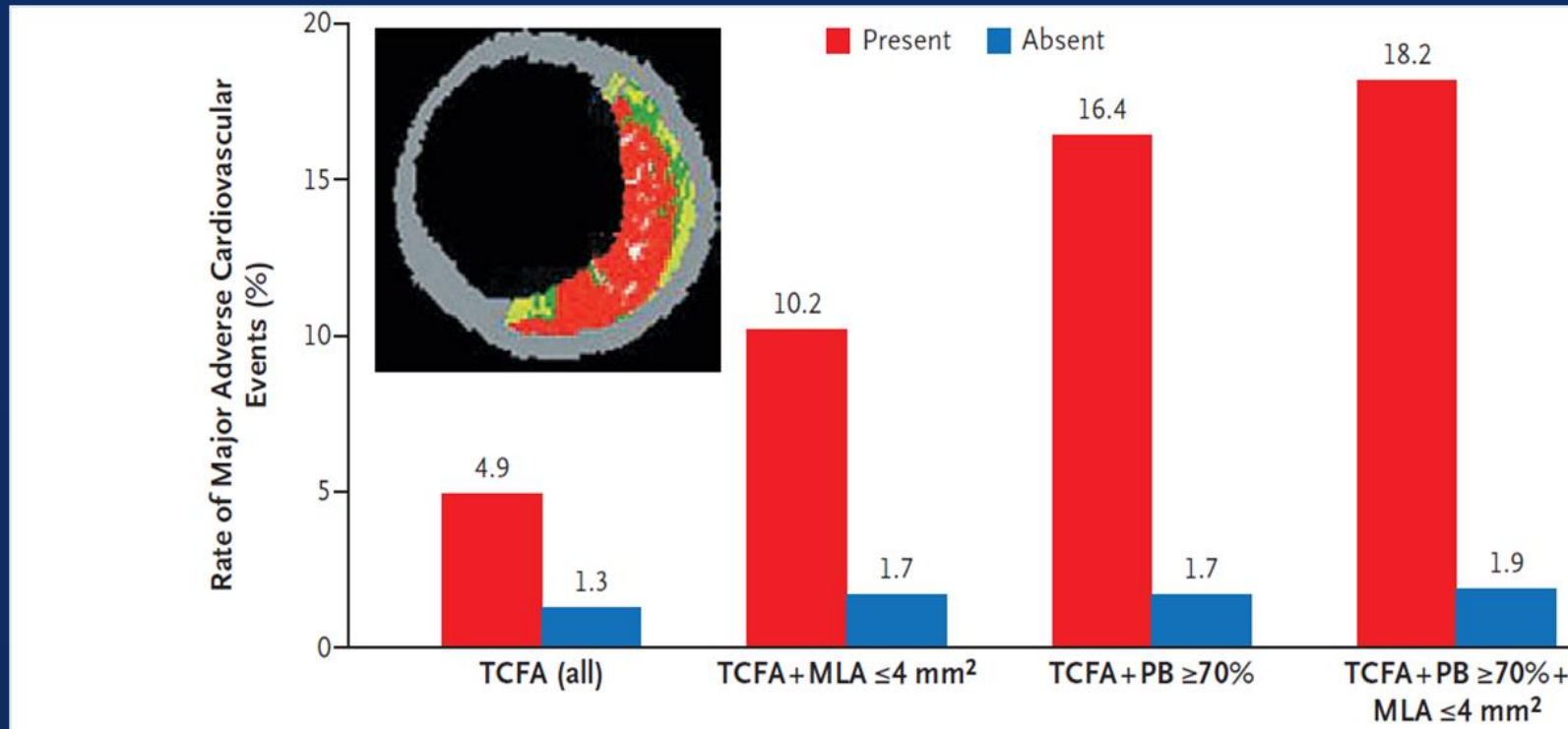

Predictors	Hazard ratio (95% CI)	p
Plaque burden $\geq 70\%$	5.03 (2.51 – 10.11)	<0.001
Thin-cap fibroatheroma	3.35 (1.77 – 6.36)	<0.001
MLA $\leq 4.0 \text{ mm}^2$	3.21 (1.61 – 6.42)	0.001

PROSPECT II Study

900 pts with ACS at up to 20 hospitals
in Sweden, Denmark and Norway (SCAAR)

NSTEMI or STEMI $>12^{\circ}$

IVUS + NIRS (blinded) performed in culprit vessel(s)

Successful PCI of all intended lesions (by angio \pm FFR/iFR)



Formally enrolled



3-vessel imaging post PCI

Culprit artery, followed by non-culprit arteries

Angiography (QCA of entire coronary tree)

IVUS + NIRS (blinded) (prox 6-8 cm of each coronary artery)



PROSPECT II Study

PROSPECT ABSORB RCT

900 pts with ACS after successful PCI

3 vessel IVUS + NIRS (blinded)

≥1 IVUS lesion with ≥65% plaque burden present?

Yes

(N=300)

No

(n=600)

R
1:1

**ABSORB BVS +
GDMT** (N~150)

GDMT
(N=150)

Routine angio/3V IVUS-NIRS FU at 2 years

Clinical FU for up to 15 years

The Preventive Coronary Intervention on Stenosis With Functionally Insignificant Stenosis
With Vulnerable Plaque Characteristics

PREVENT Trial

Symptomatic or Asymptomatic CAD patients

Any epicardial coronary stenosis
with **FFR ≥ 0.80** and with **Two** of the following

- IVUS MLA $\leq 4.0\text{mm}^2$
- IVUS Plaque Burden $>70\%$
- TCFA by OCT or VH-IVUS
- Lipid-Rich Plaque on NIRS ($_{\text{max}}\text{LCBI}_{4\text{mm}} > 400$)

R

XIENCE+OMT
N=800

OMT
N=800

Primary endpoint at 2 years: CV death, MI, Hospitalization d/t unstable angina

OCT sub-study/ NIRS sub-study (300 patients in each arm at 2 years)

The Preventive Coronary Intervention on Stenosis With Functionally Insignificant Stenosis With Vulnerable Plaque Characteristics

PREVENT Trial

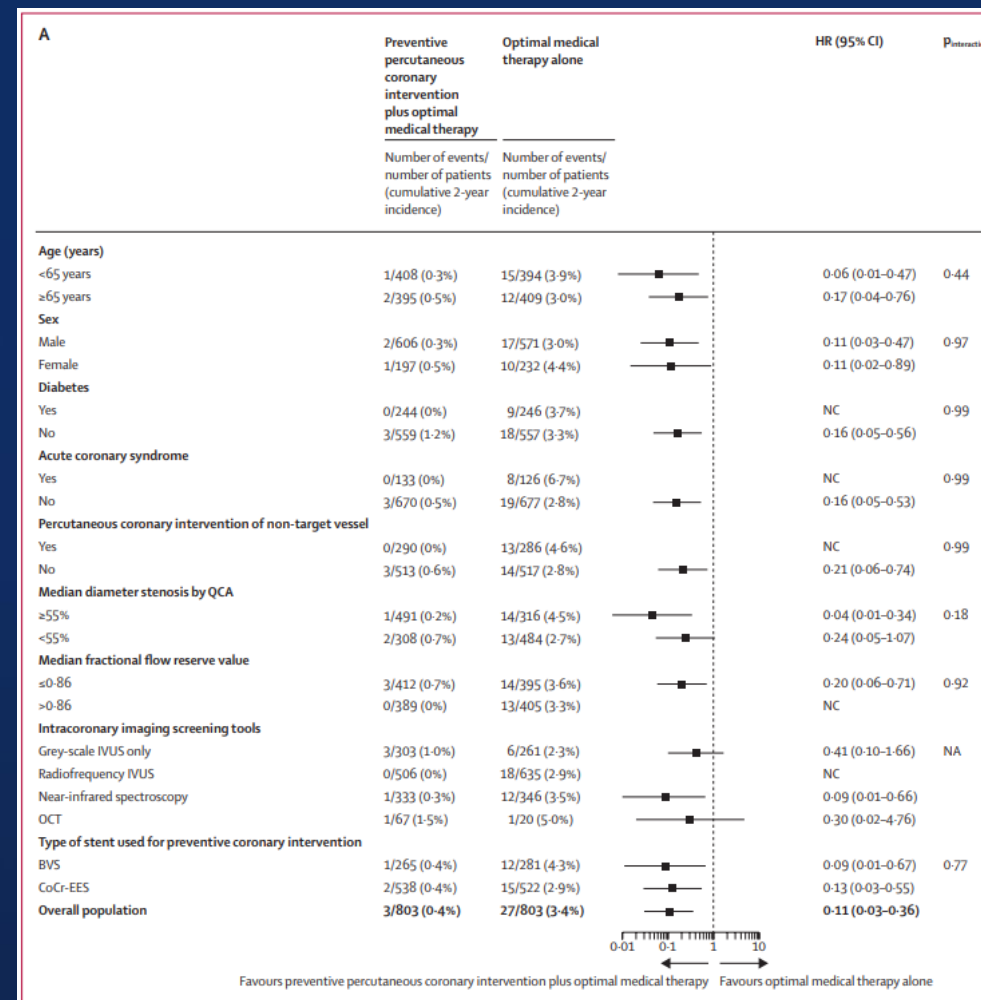
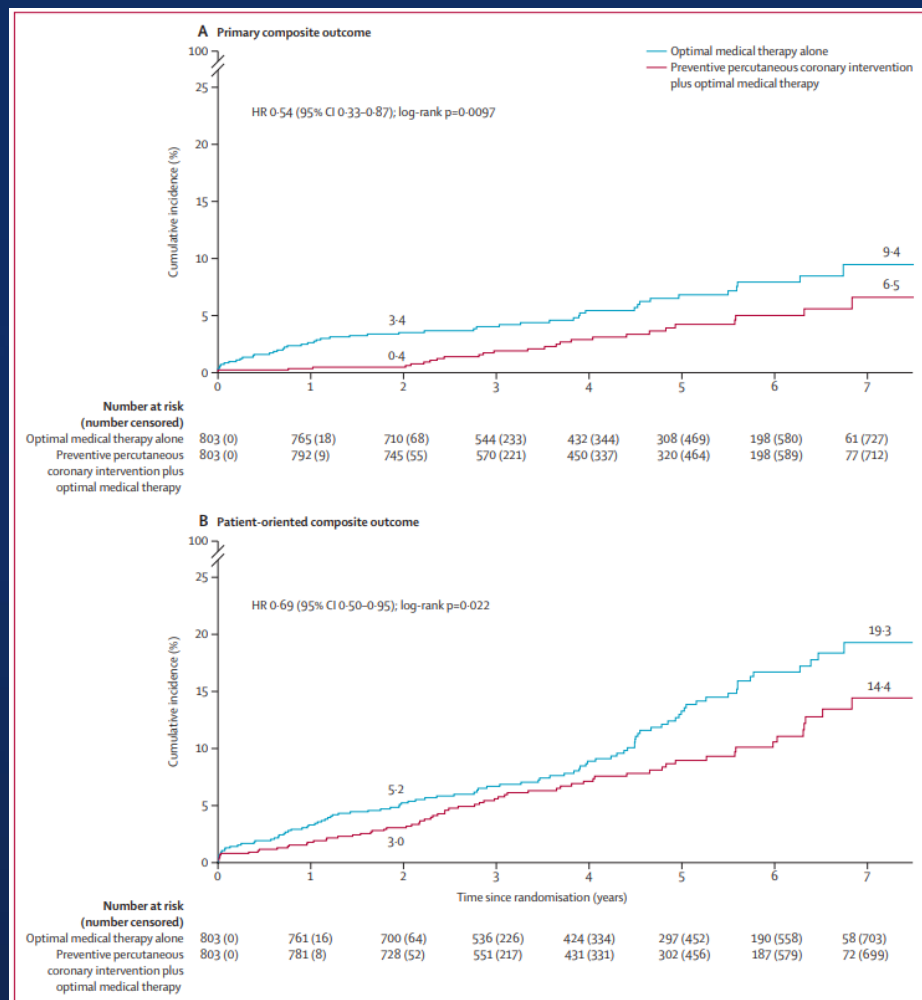

Imaging guided PCI

Angiography is a 'Luminography'

Lesion Orientation

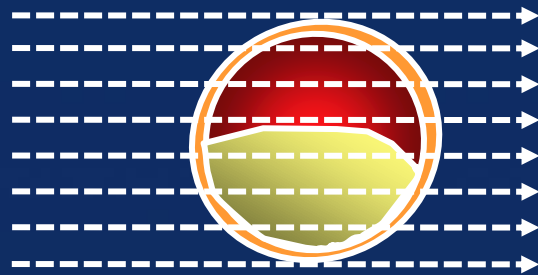

Angiographic Image of Eccentric Lesion

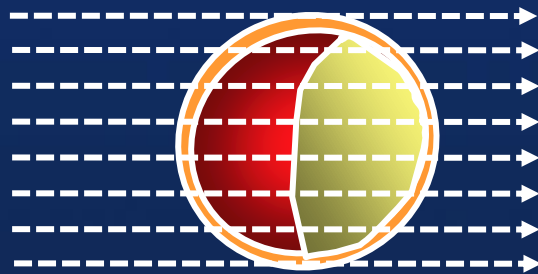
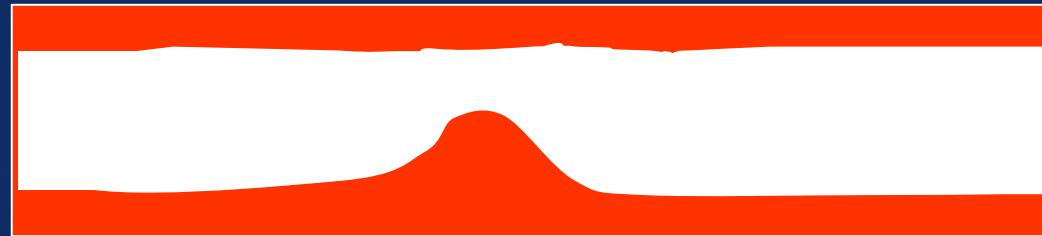

Intracoronary Imaging Visualizes the “Real” Vessel

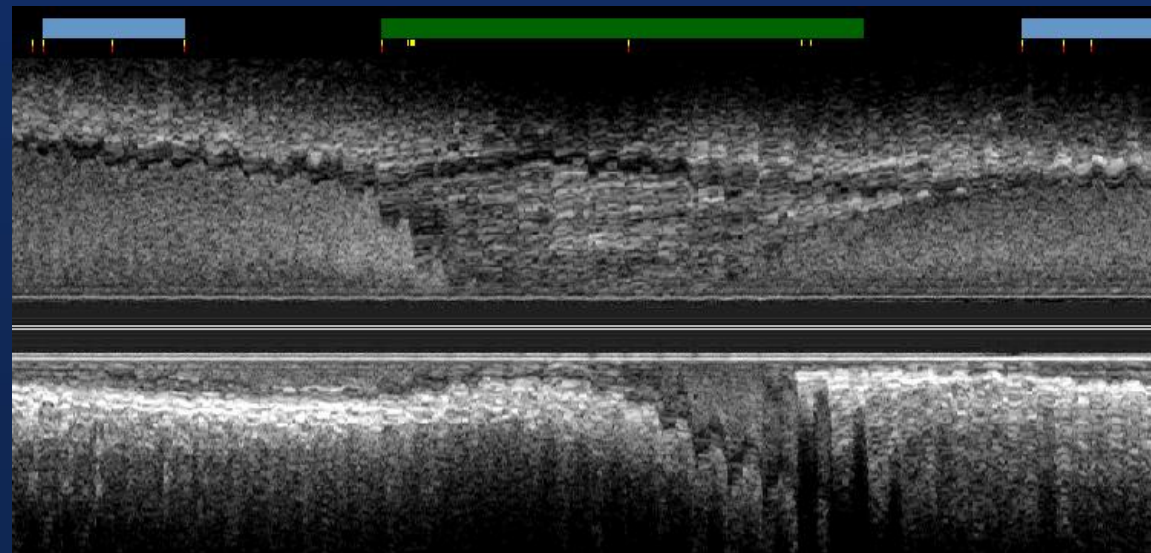
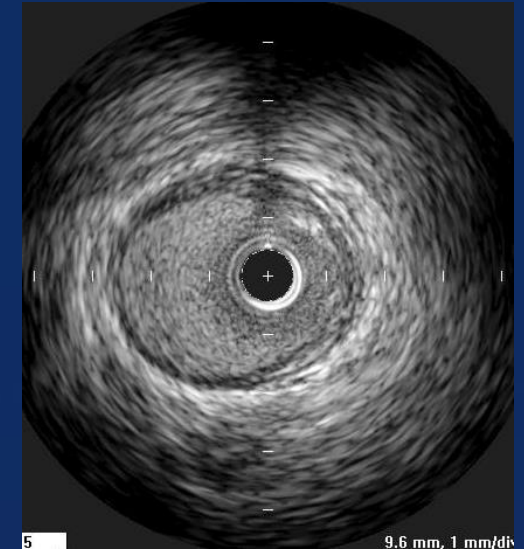
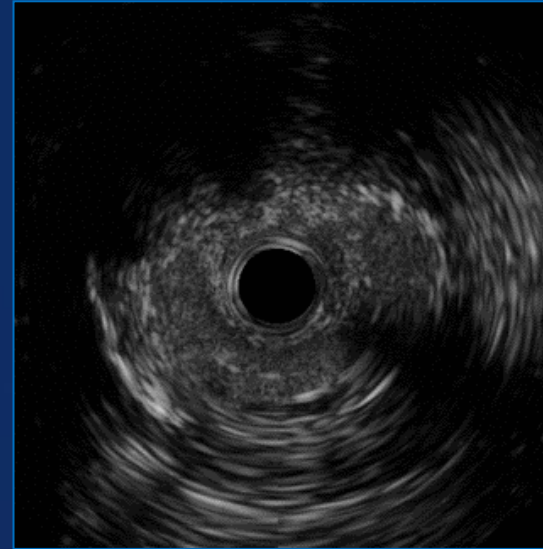
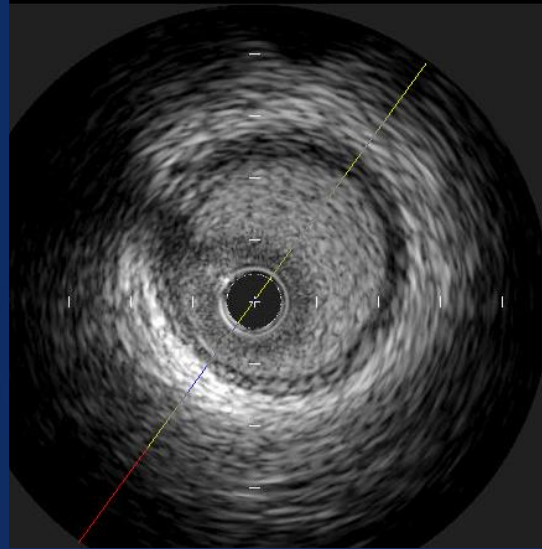
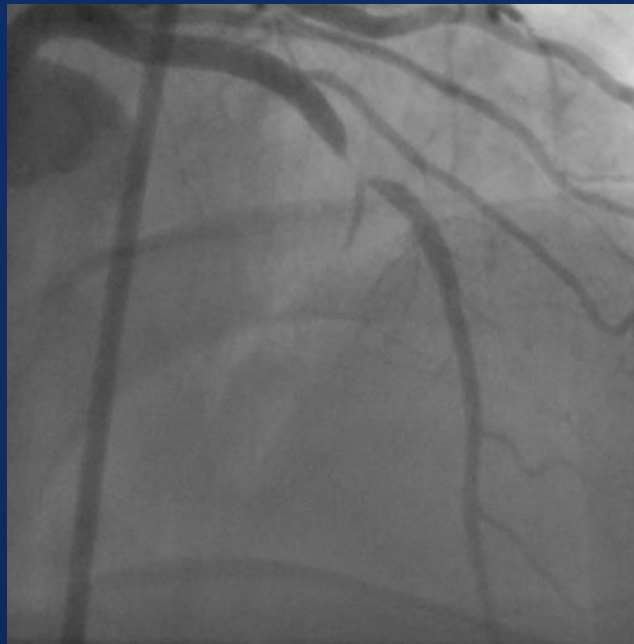

Assess Optimal Balloon / Stent Size & Landing Zone (Length)

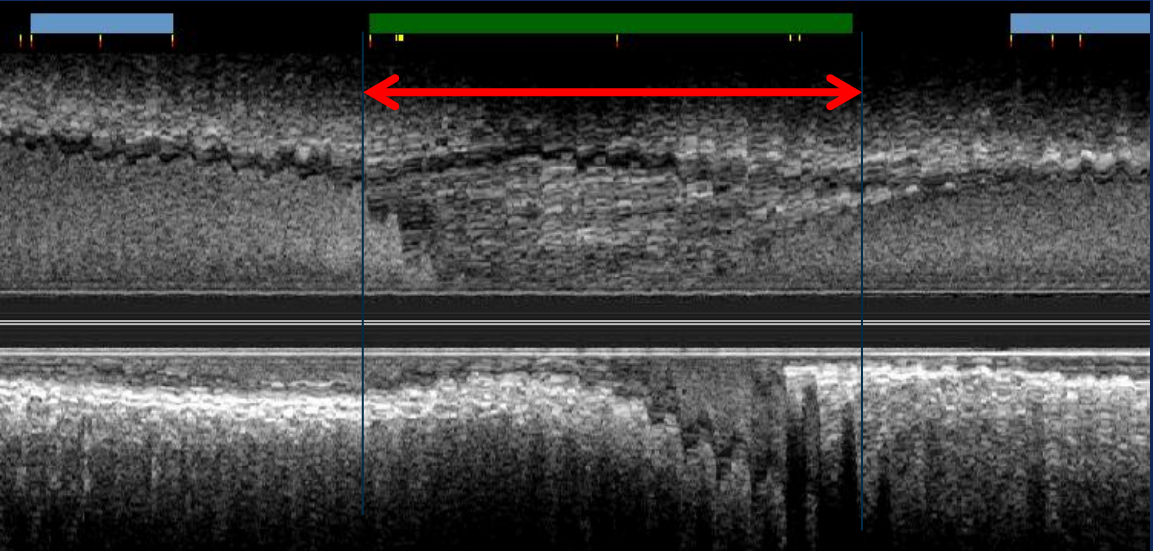

Review of Post-stenting Results (Apposition / Expansion)

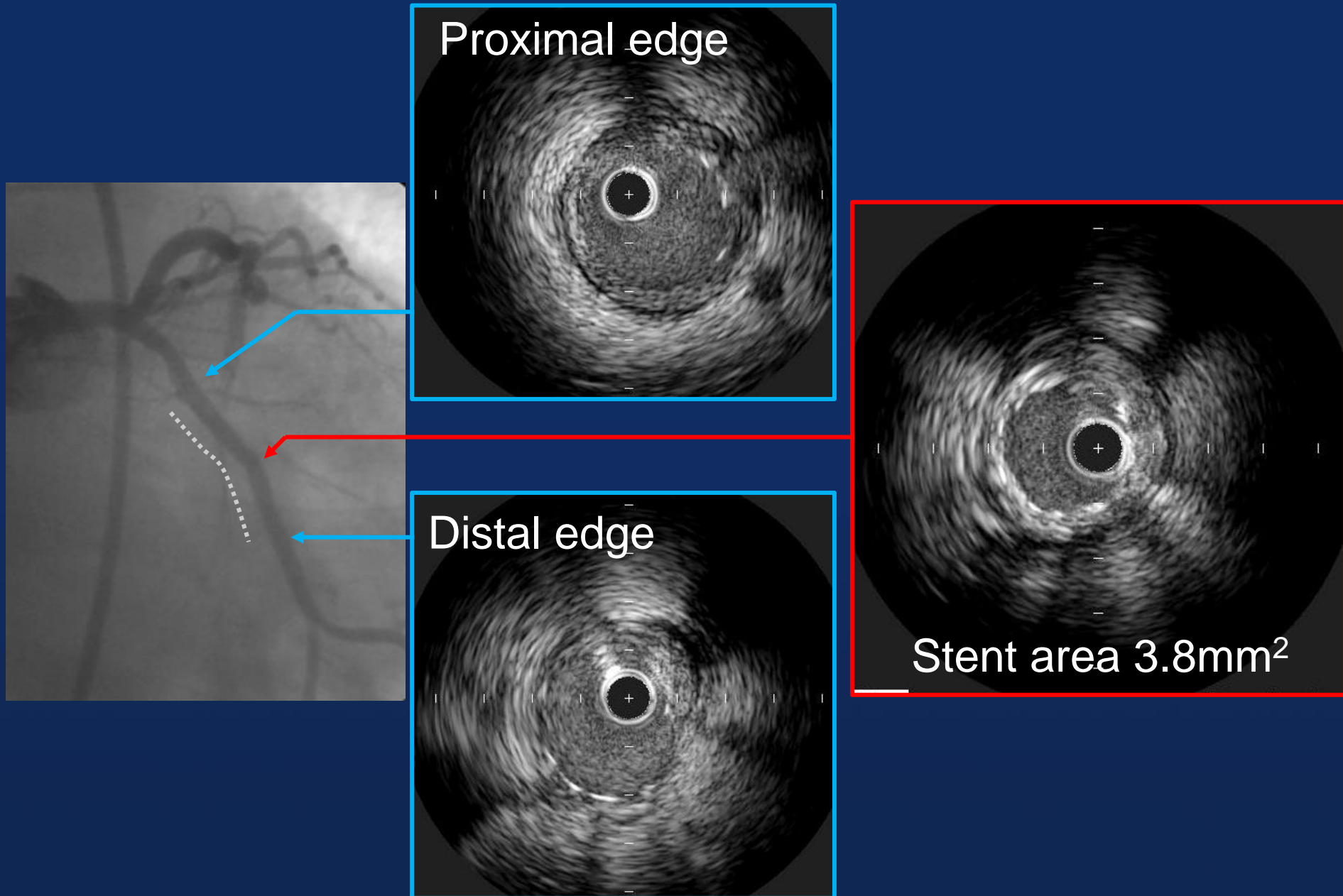

Identify Edge Problems – Dissections, Hematoma

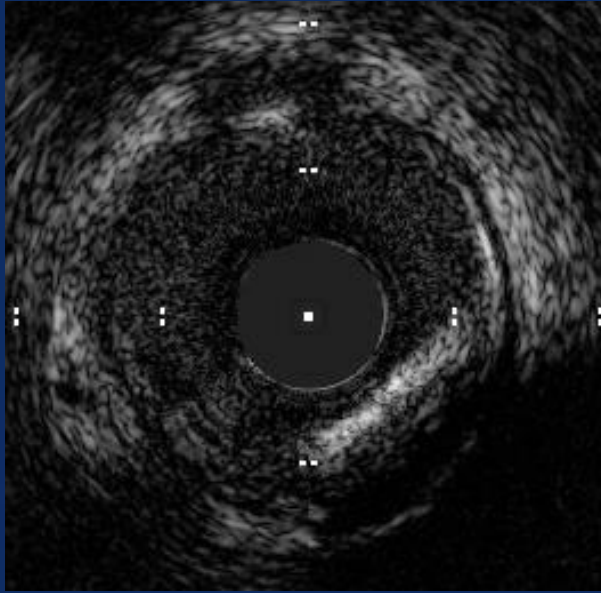

Intimal

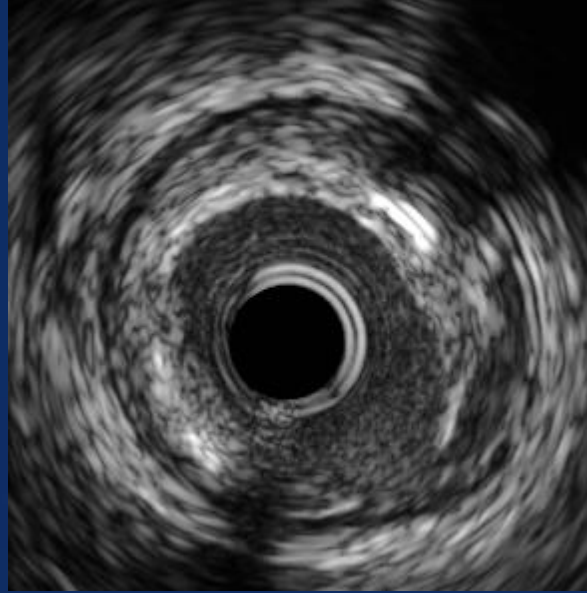

Medial

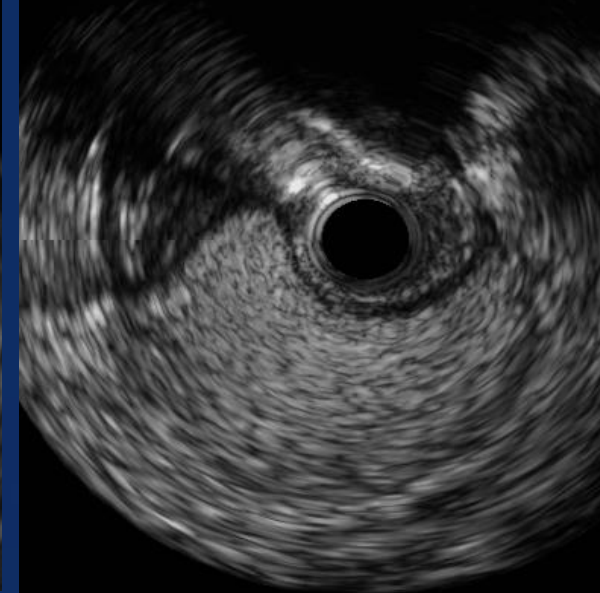

Intramural Hematoma

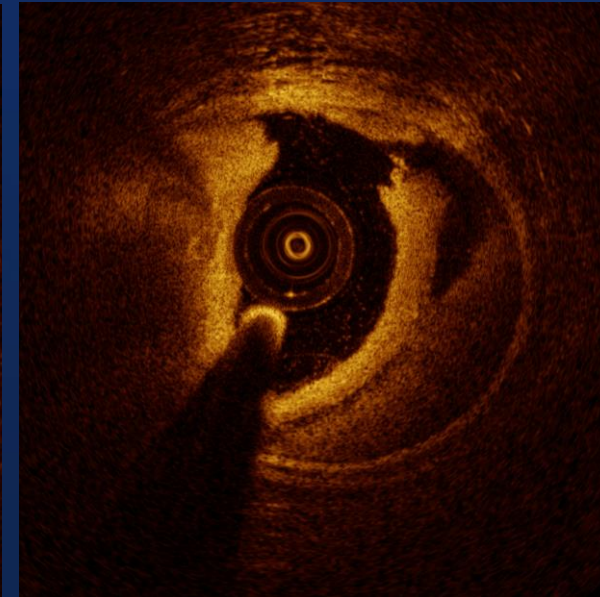
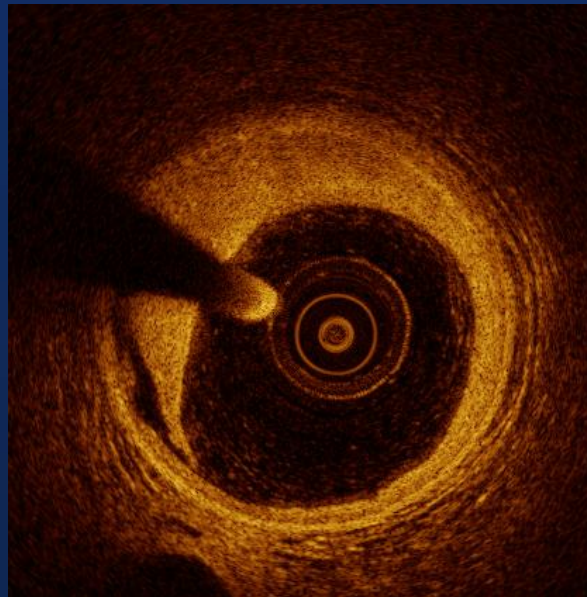
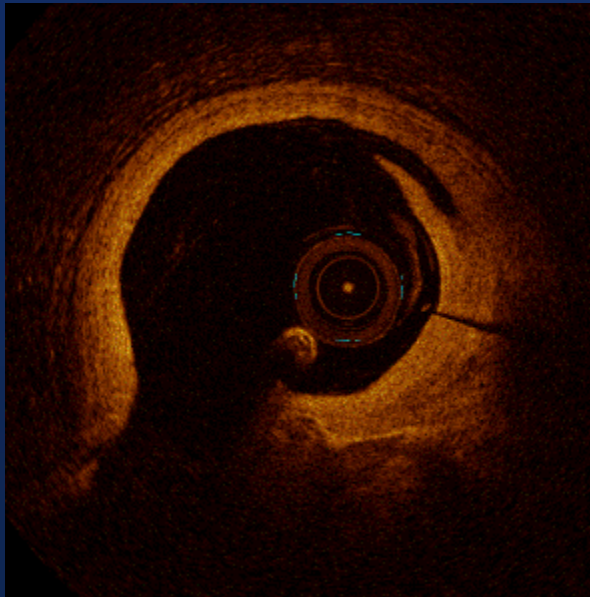

Use of intracoronary imaging

CENTRAL ILLUSTRATION Best Practice Summary for Use of Intracoronary Imaging

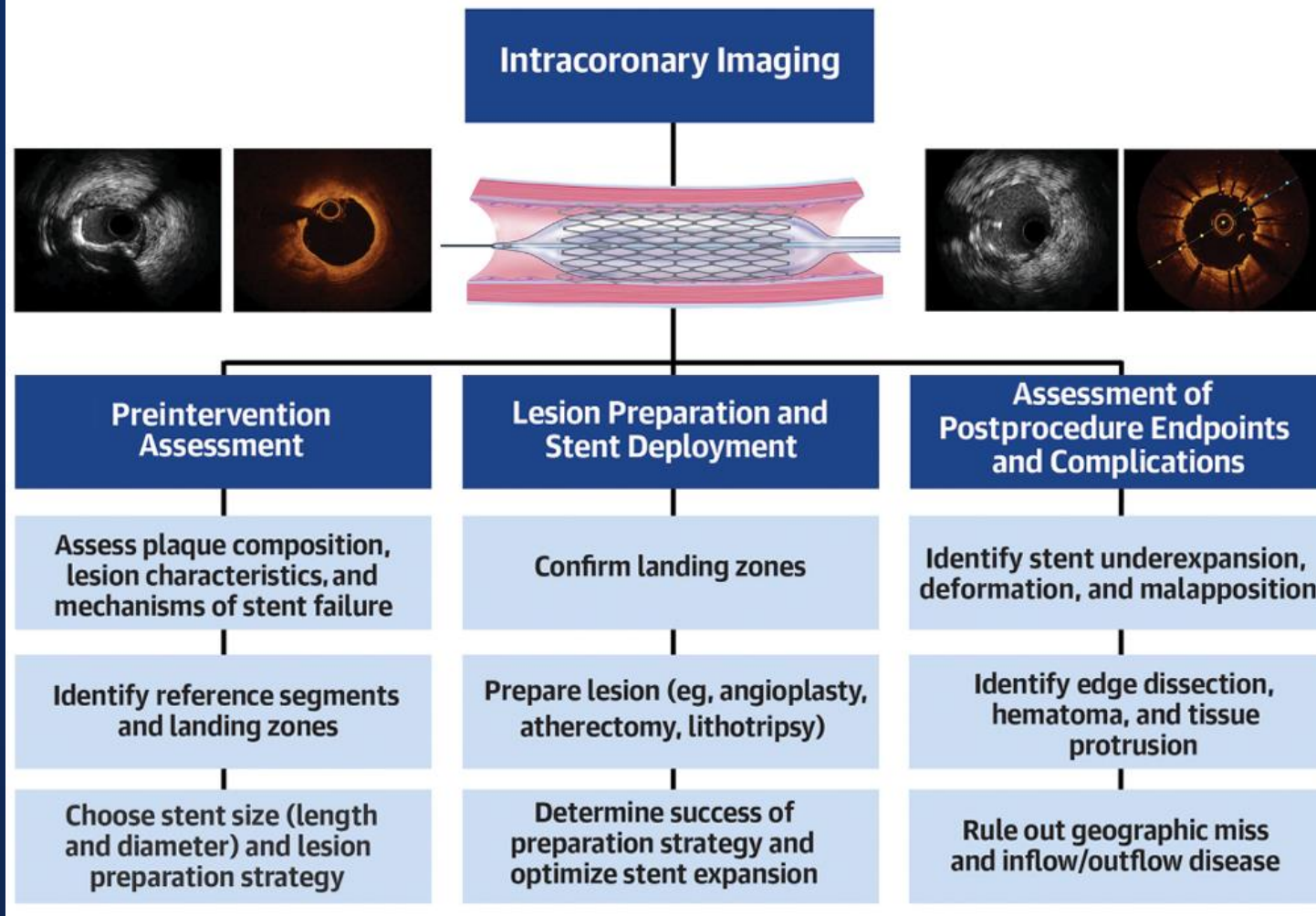

How Intravascular Imaging Changed Procedure?

ADAPT-DES: Procedural Changes After IVUS in 74%

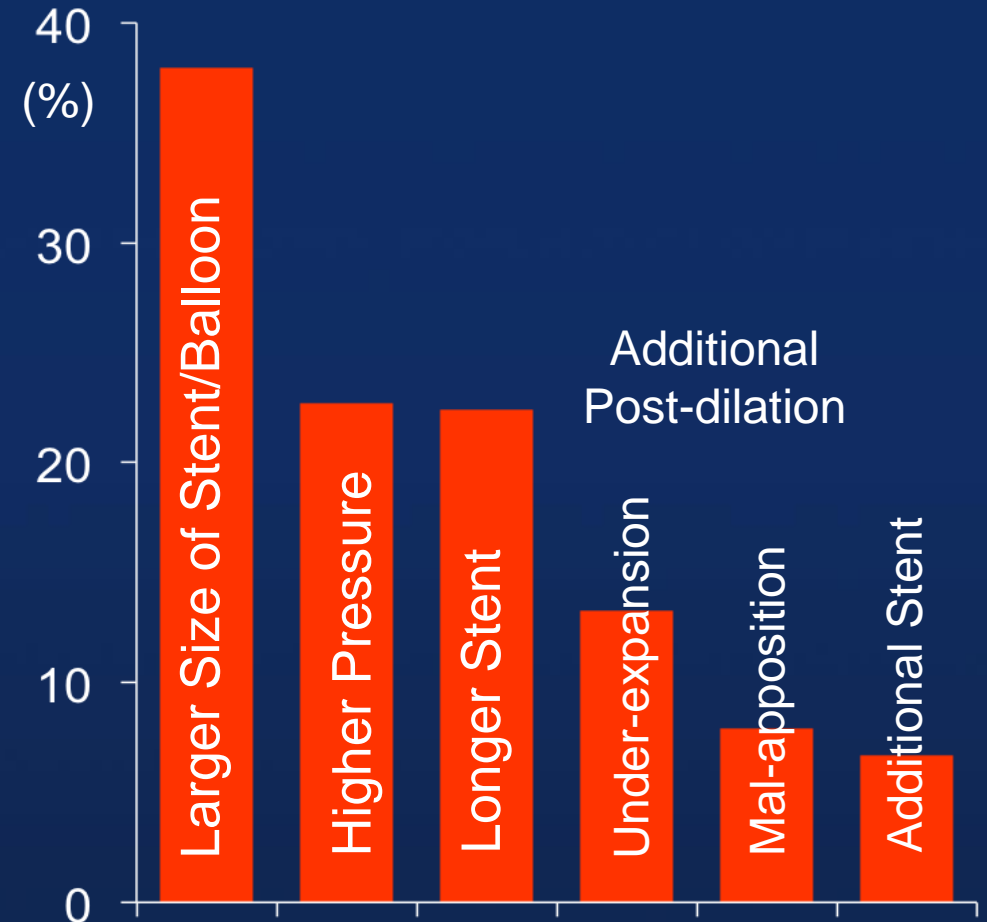
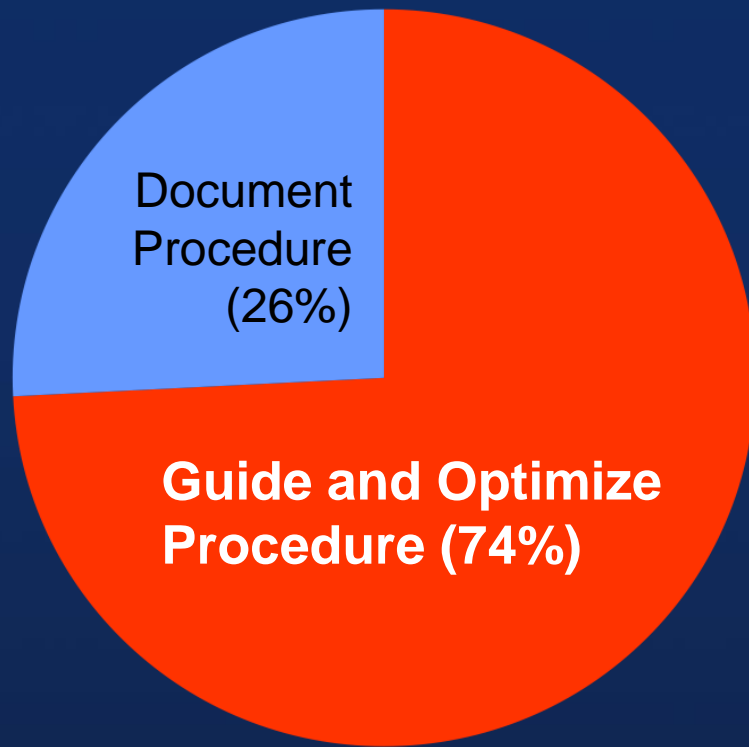

IVUS Improved Clinical Outcomes in Large RCTs

IVUS-XPL (Long lesions)

MACE (CD+TL-MI+ID-TLR)

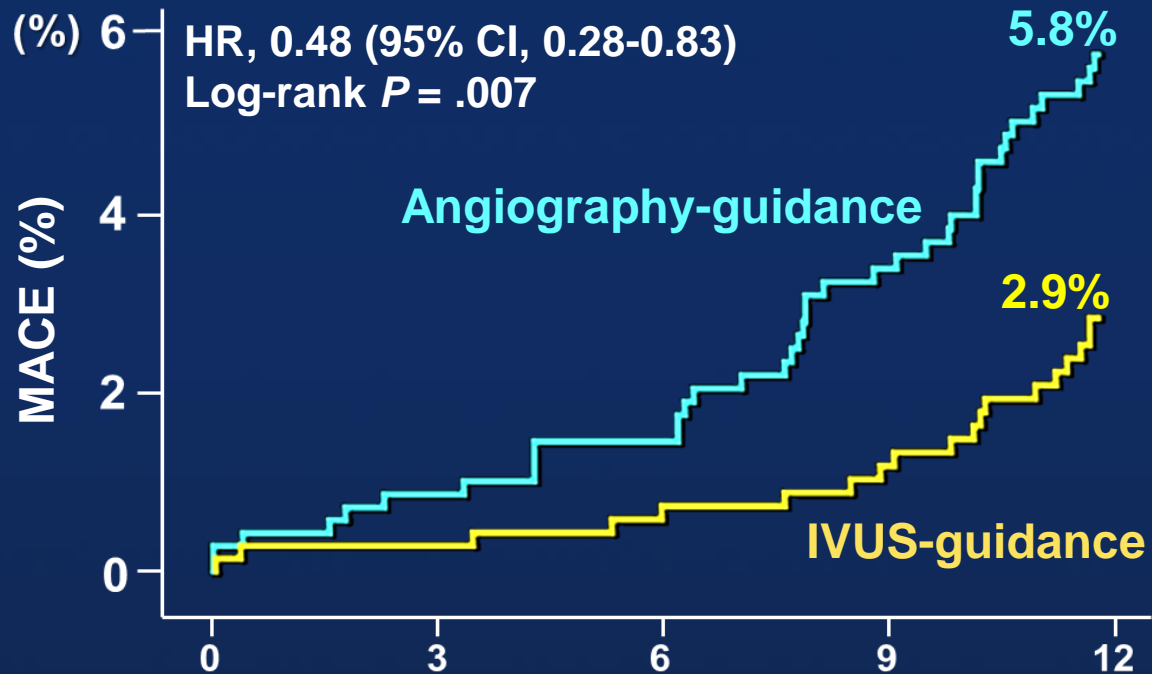

No. at risk	Time Since Randomization, mo				
	0	3	6	9	12
Angiography arm	700	673	660	643	624
IVUS arm	700	671	665	654	641

ULTIMATE (All-comer)

TVF (CD+TV-MI+CD-TVR)

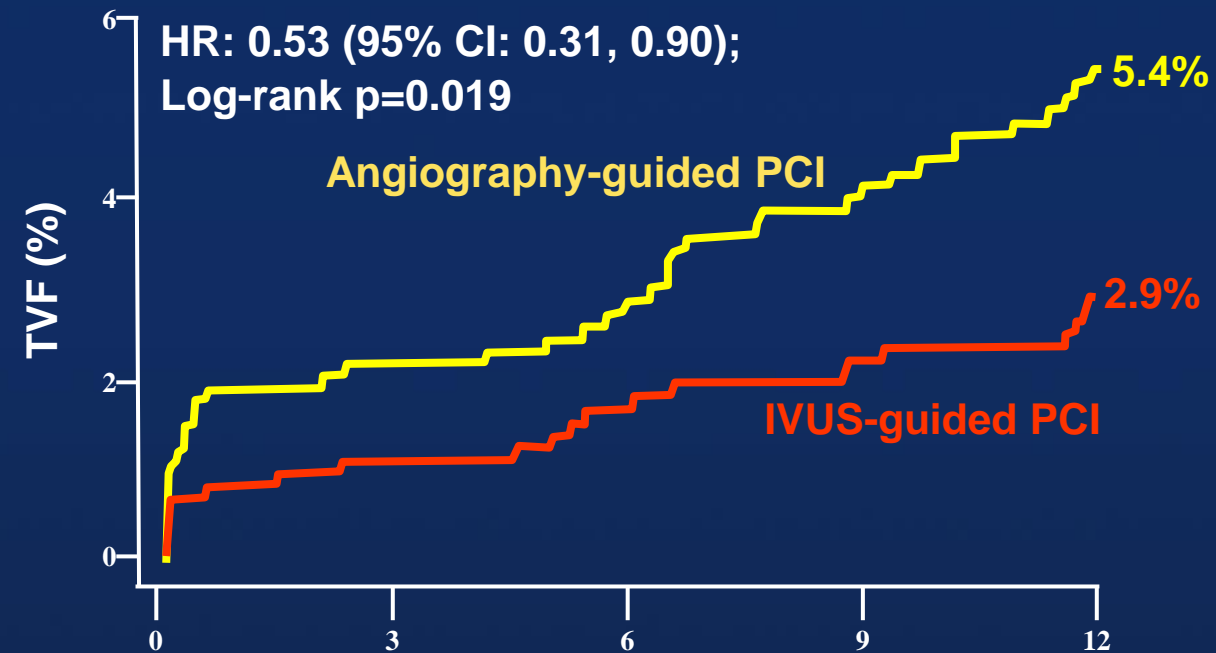

No. at risk	Time (months)				
	0	3	6	9	12
Angiography	724	706	698	685	676
IVUS	724	715	710	704	696

IVUS Improved Clinical Outcomes in CTO PCI

RCT (n=402), Primary endpoint : Cardiac death, MI, and TVR

Intention-to-Treat

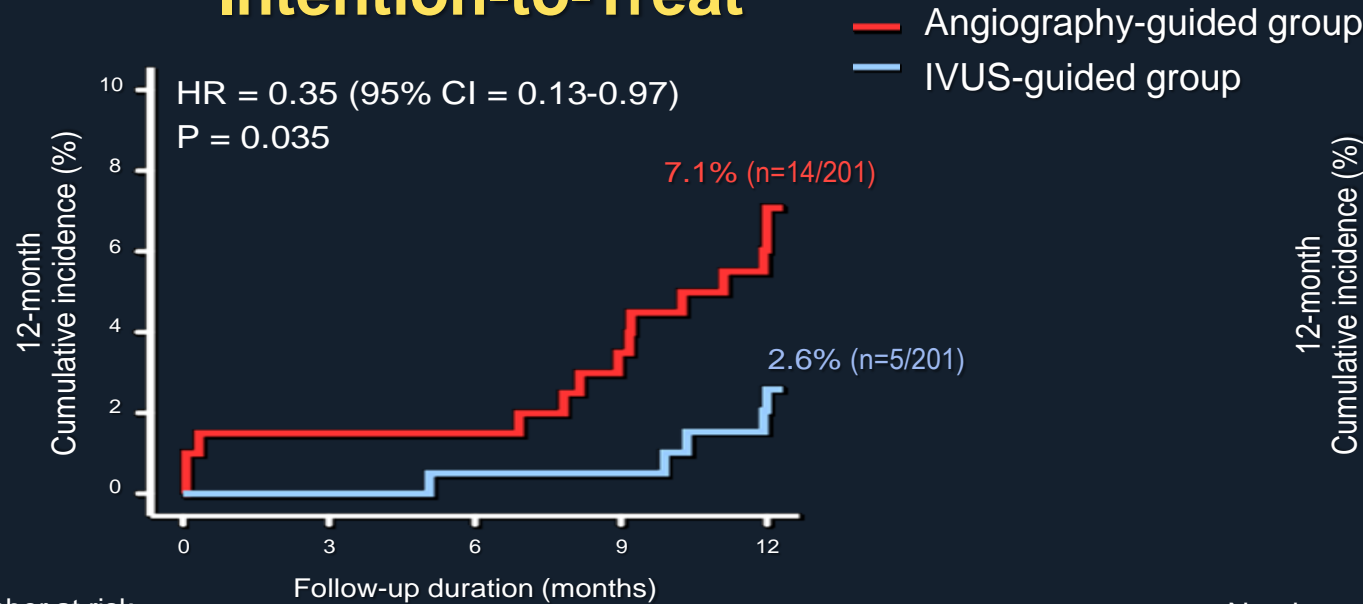

Number at risk			
	0	6	12
Angiography	201	198	179
IVUS	201	198	186

	IVUS	Angio	P-value
Cardiac death/MI	0%	2%	0.045
TVR	2.6%	5.2%	0.186

Per Protocol

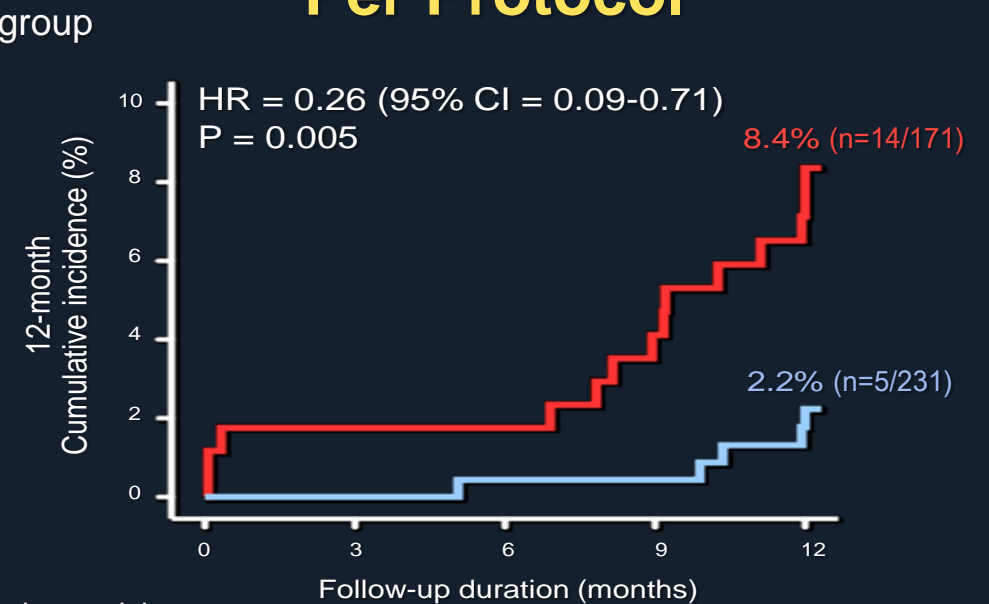

Number at risk			
	0	6	12
Angiography	171	167	151
IVUS	231	229	214

	IVUS	Angio	P-value
Cardiac death/MI	0%	2.3%	0.019
TVR	2.2%	6.1%	0.049

IVUS Use was Associated with Better 10-yr Outcomes after LM PCI

MAIN-COMPARE Registry

Left Main Disease



10-Year
Follow-up



IVUS-guided PCI

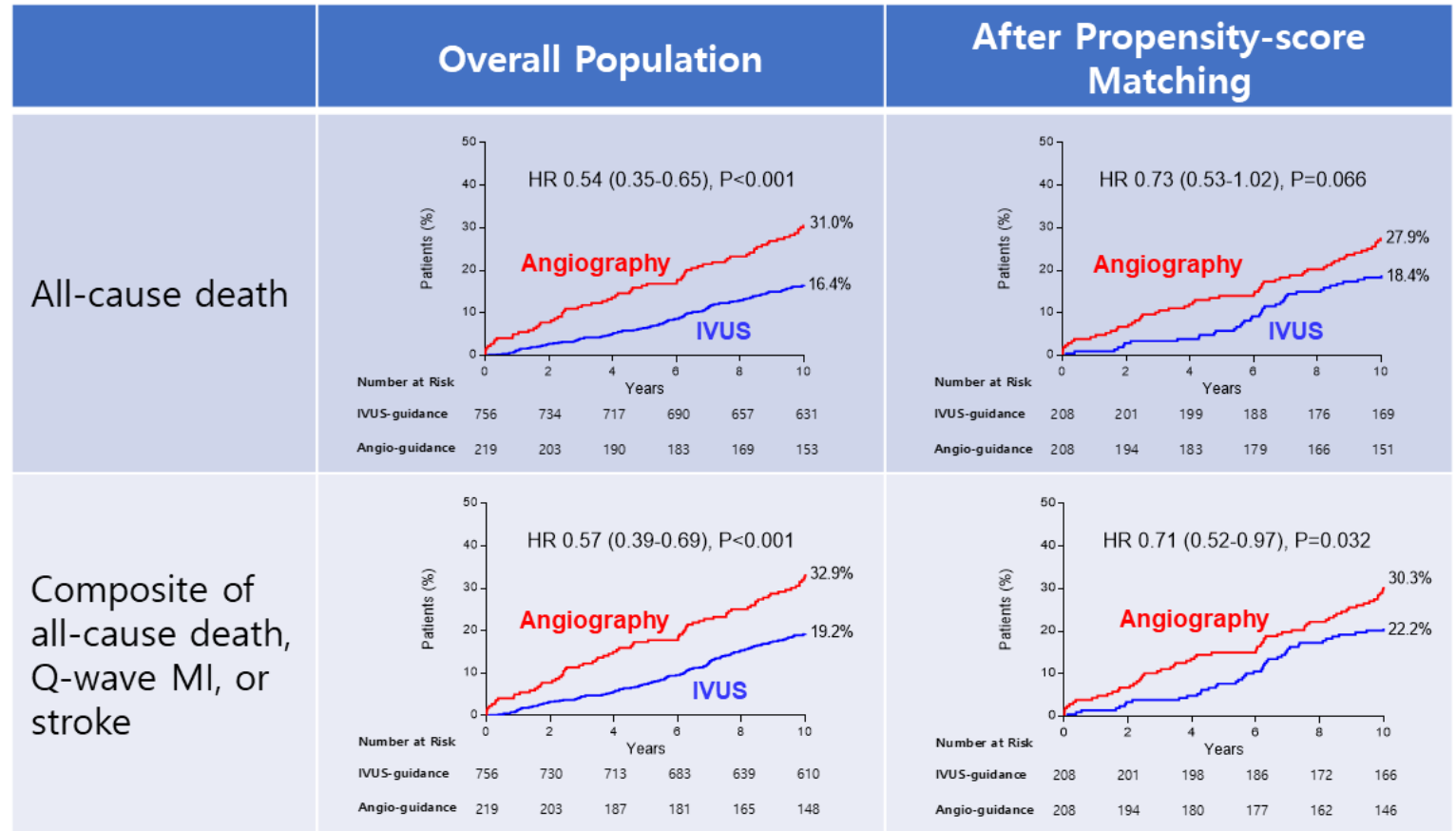
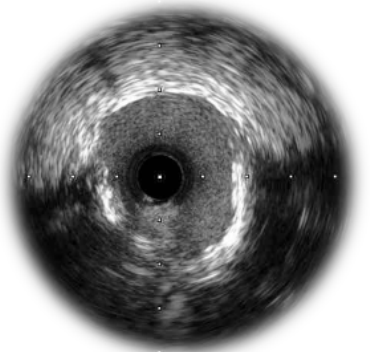

Updated Meta-analysis of 10 RCTs

IVUS use was associated with Better Clinical Outcomes (N=5160)

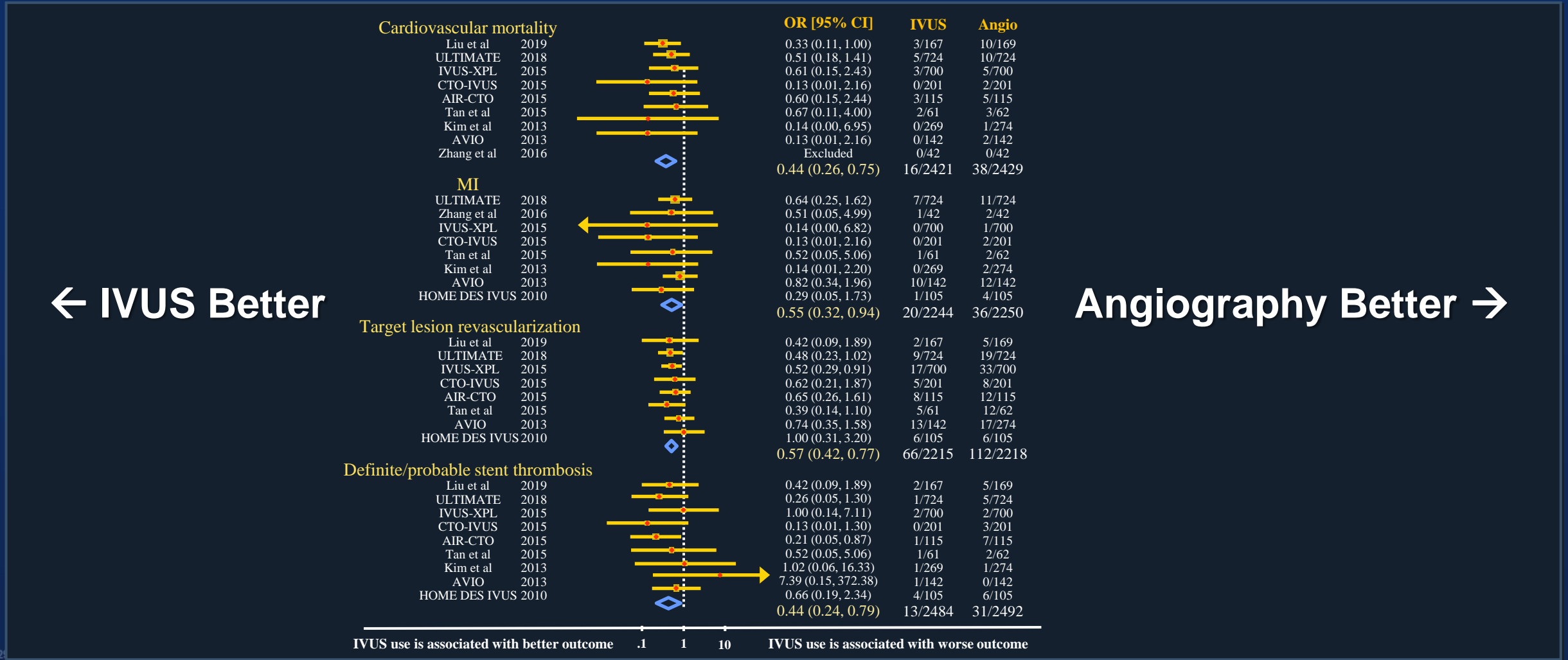

← IVUS Better

Angiography Better →

IVUS use is associated with better outcome .1 1 10 IVUS use is associated with worse outcome

2021 ACC/AHA PCI Guideline for Intracoronary Imaging

	COR	LOE
➤ In patients undergoing coronary stent implantation, IVUS can be useful for procedural guidance, particularly in cases of left main or complex coronary artery stenting, to reduce ischemic events	Ia	B
➤ In patients undergoing coronary stent implantation, OCT is a reasonable alternative to IVUS for procedural guidance, except in ostial left main disease	Ia	B
➤ In patients with stent failure, IVUS or OCT is reasonable to determine the mechanism of stent failure	Ia	C

The Best Cut-off of Edge Restenosis

Plaque Burden <55%

433 E-ZES

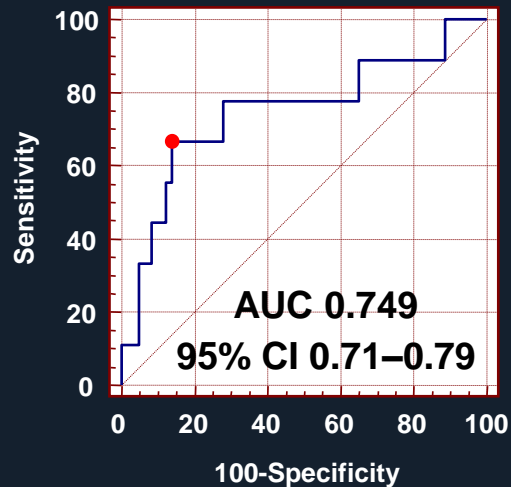

PB 56.3%

Sensitivity 67%

Specificity 86%

422 R-ZES

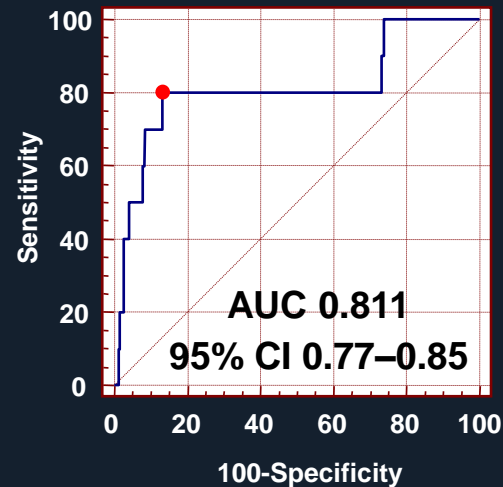

PB 57.3%

Sensitivity 80%

Specificity 87%

813 EES

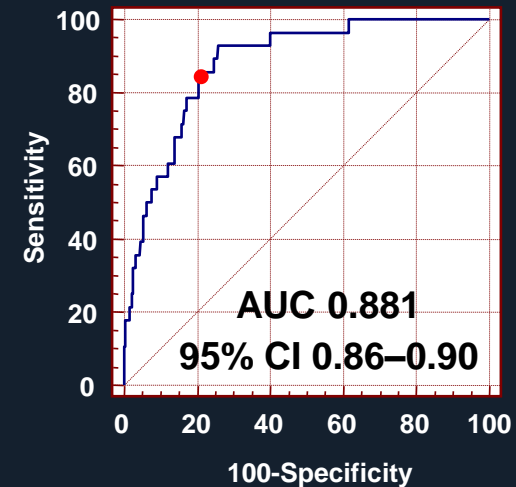

PB 54.2%

Sensitivity 86%

Specificity 80%

Effective Stent Area (> 5.0 mm²), Can Lower TLR <2%

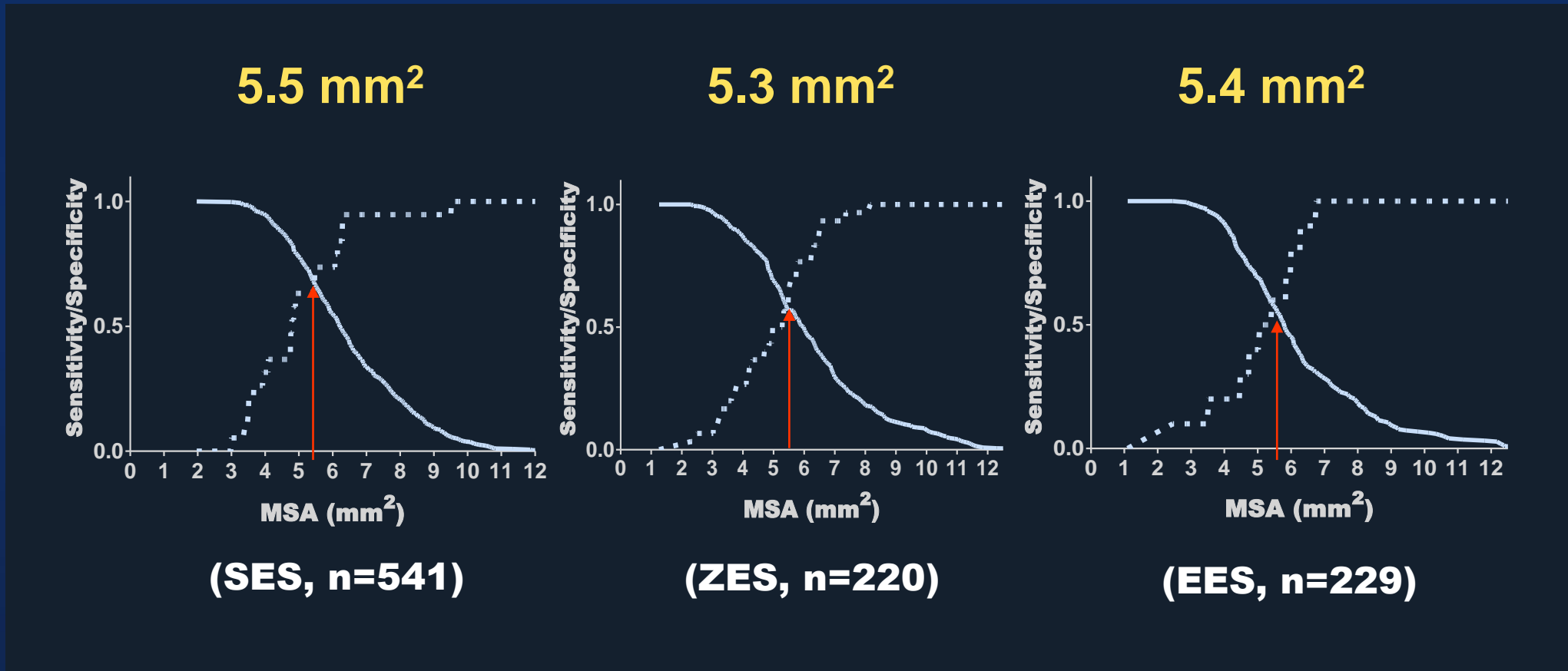

Stent Area after LM Bifurcation PCI : the Bigger the Better

Rule of 5, 6, 7, 8

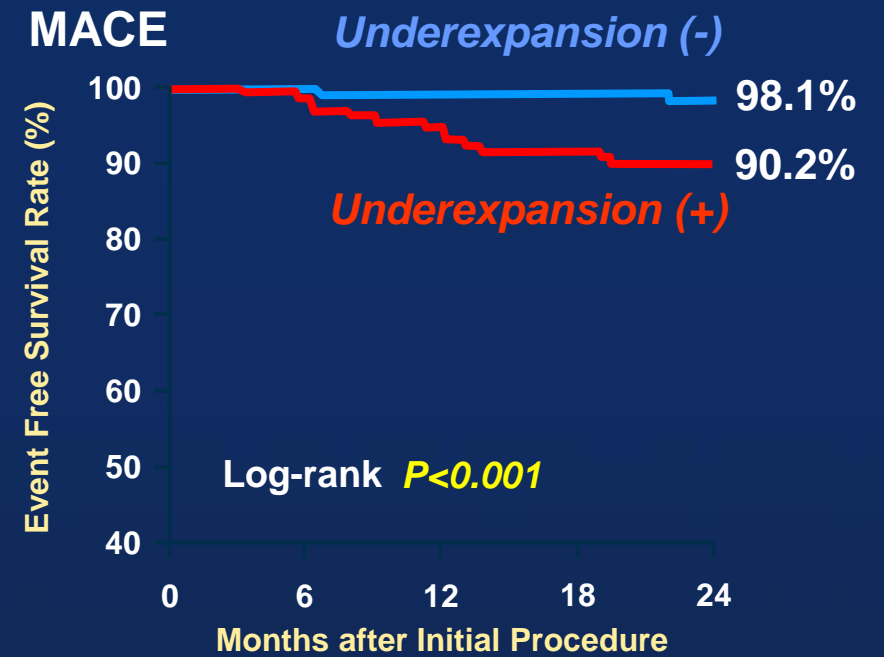
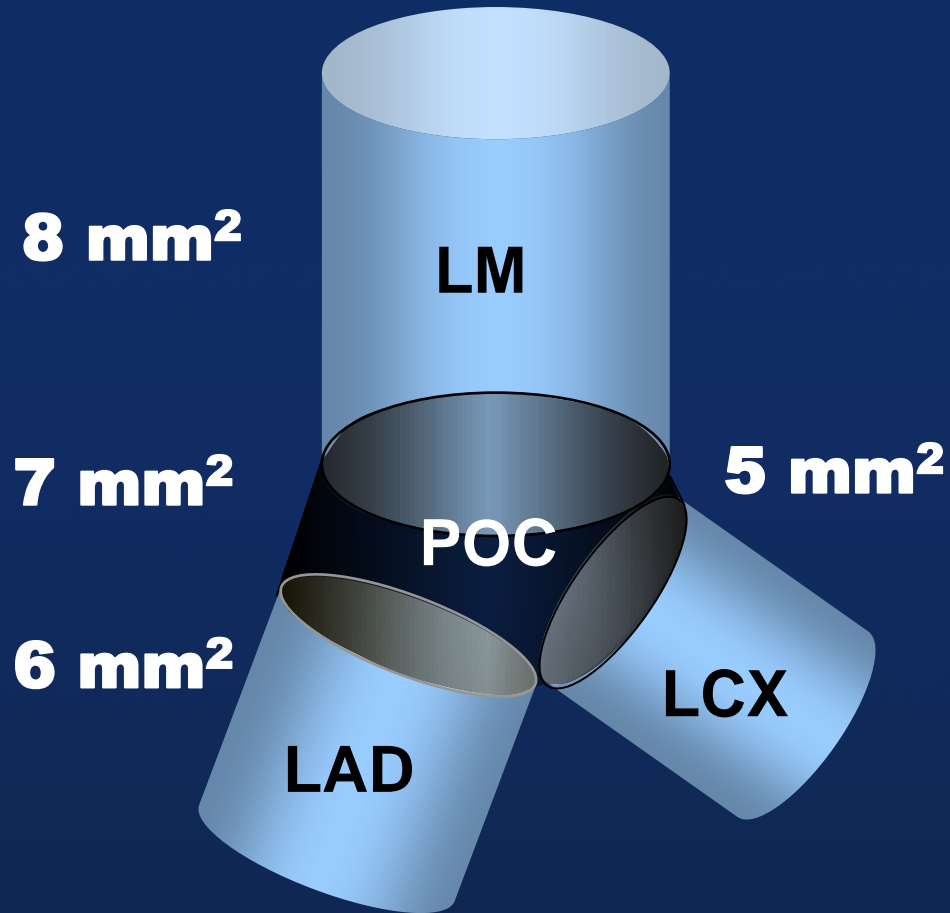

No. at risk	0	6	12	18	24
Underexpansion (+)	133	131	126	121	75
Underexpansion (-)	260	260	255	246	129

Imaging-Guided PSP

Under the Intracoronary Imaging Guidance

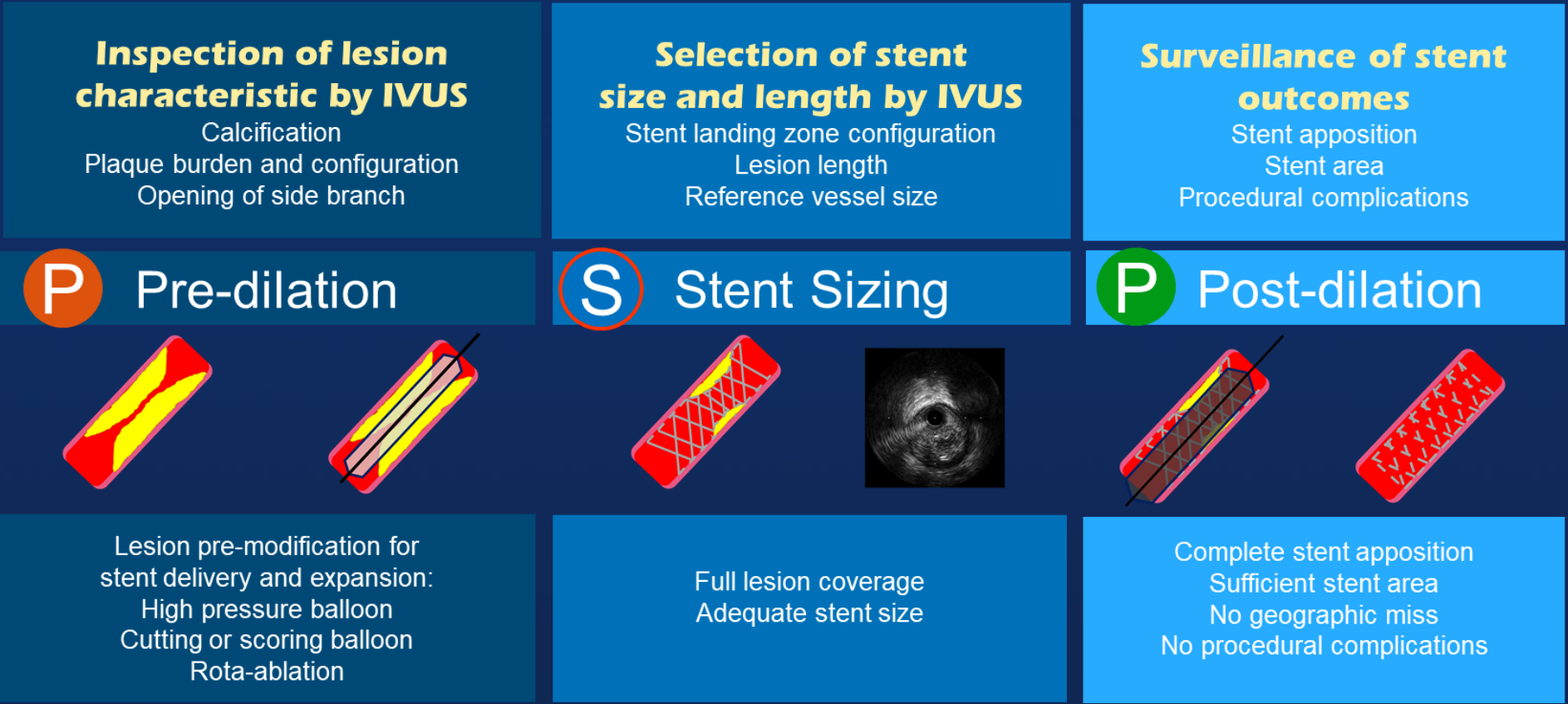

Imaging-Guided PSP, What Is Different?

Stent Number

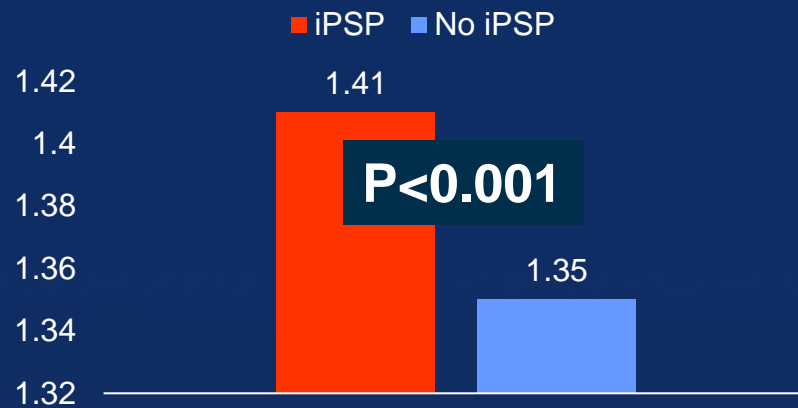

Stent Length (mm)

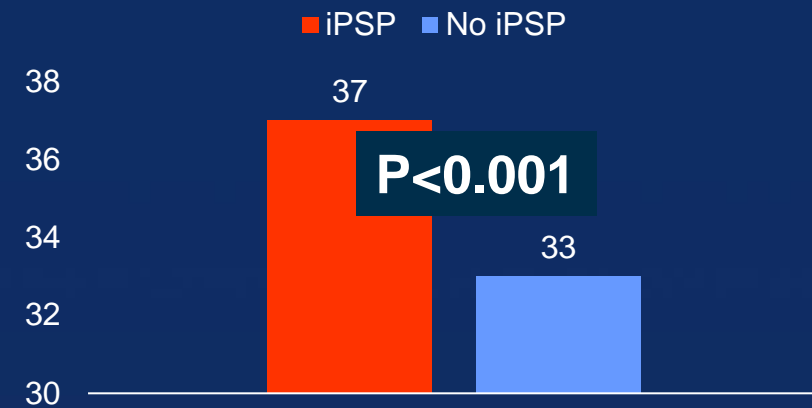

Stent Diameter (mm)



Final Balloon Size (mm)



Imaging-Guided Complex PCI – Better Clinical Outcome

	Crude cumulative incidence (%)			Multivariate analysis		PS matching		IPTW	
	iPSP	No iPSP	P	HR (95% CI)	P	HR (95% CI)	P	HR (95% CI)	P
Primary outcome	5.7	8.0	0.001	0.74 (0.61-0.90)	0.003	0.71 (0.56-0.90)	0.005	0.71 (0.63-0.81)	<0.001
Cardiac death	2.3	3.6	0.003	0.73 (0.53-0.99)	0.047	0.78 (0.53-1.15)	0.20	0.62 (0.51-0.75)	0.003
Target vessel MI	0.2	0.5	0.19	0.68 (0.30-1.55)	0.36	0.78 (0.29-2.09)	0.62	0.65 (0.38-1.10)	0.10
TVR	3.4	4.6	0.02	0.73 (0.57-0.94)	0.02	0.68 (0.50-0.92)	0.01	0.74 (0.63-0.87)	<0.001

Post-dilation was the Most Significant Event Predictor Among 3 Components of iPSP

	Univariate analysis		Multivariate analysis*	
	HR (95% CI)	P value	HR (95% CI)	P value
Pre-dilation	0.89 (0.69-1.15)	0.374	0.84 (0.64-1.11)	0.216
Stent-sizing	0.79 (0.67-0.93)	0.004	0.89 (0.74-1.07)	0.219
Post-dilation	0.79 (0.67-0.94)	0.006	0.80 (0.67-0.96)	0.016

Post-Balloon Size was Larger With IVUS

Pre-dilation	IVUS	Post-dilation	No. of patients (%)	Stent diameter (mm)	Post balloon size (mm)	Annualized event rate	Adjusted HR (95% CI)	P value
No	No	Yes	129 (1.4)	3.04 ± 0.41	3.10 ± 0.81	3.04 %	0.81 (0.35-1.85)	0.613
				Δ +0.05 (P=0.550)				
Yes	No	Yes	1719 (18.0)	3.08 ± 0.38	3.12 ± 0.86	3.07 %	0.80 (0.53-1.21)	0.297
				Δ +0.04 (P=0.104)				
No	Yes	Yes	309 (3.2)	3.43 ± 0.41	3.79 ± 0.70	2.04%	0.72 (0.39-1.35)	0.306
				Δ +0.35 (P<0.001)				
Yes	Yes	Yes	3374 (35.4)	3.26 ± 0.39	3.58 ± 0.60	1.98%	0.63 (0.42-0.93)	0.022
				Δ +0.32 (P<0.001)				

OCT vs. IVUS

OCT vs. IVUS

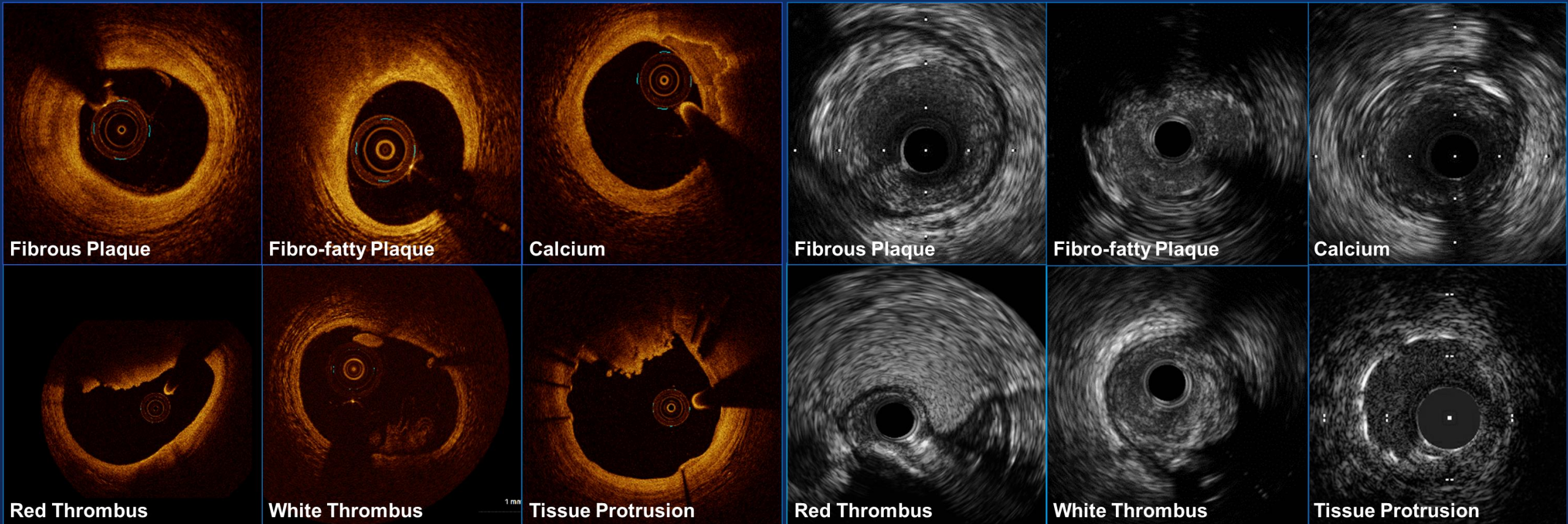

OCT vs. IVUS

	OCT	IVUS
Wave source	Near-infrared light	Ultrasound
Axial resolution, μm	1-2	38-46
Penetration depth in soft tissue, mm	1-2	>5
Blood clearance	Needs Contrast	Not required
Plaque burden at lesion	-	+
Aorto-ostial visualization	-	+
Cross-sectional calcium evaluation	Thickness, angle	Angle only
Lipidic plaque evaluation	Lipidic plaque, cap thickness	Attenuated plaque

ILUMIEN III – OPTIMIZE PCI

Randomized OCT vs. IVUS vs. Angiography

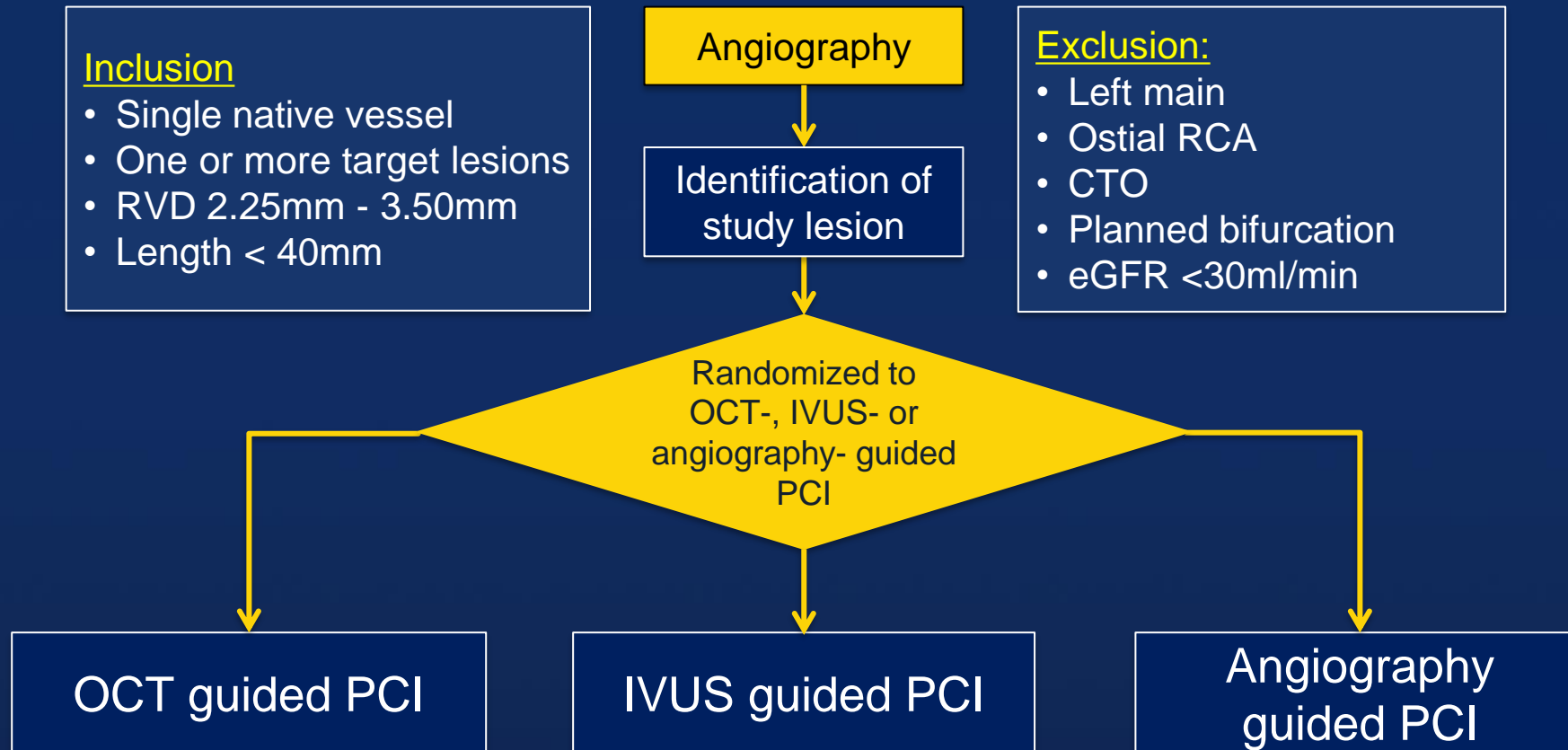

ILUMIEN III – OPTIMIZE PCI

Randomized OCT vs. IVUS vs. Angiography

Primary endpoint: Final post-PCI MSA by OCT

OCT 5.79 mm² [4.54, 7.34]

IVUS 5.89 mm² [4.67, 7.80]

97.5% one-sided CI: [-0.70, -]

$P_{noninferiority} = 0.001$

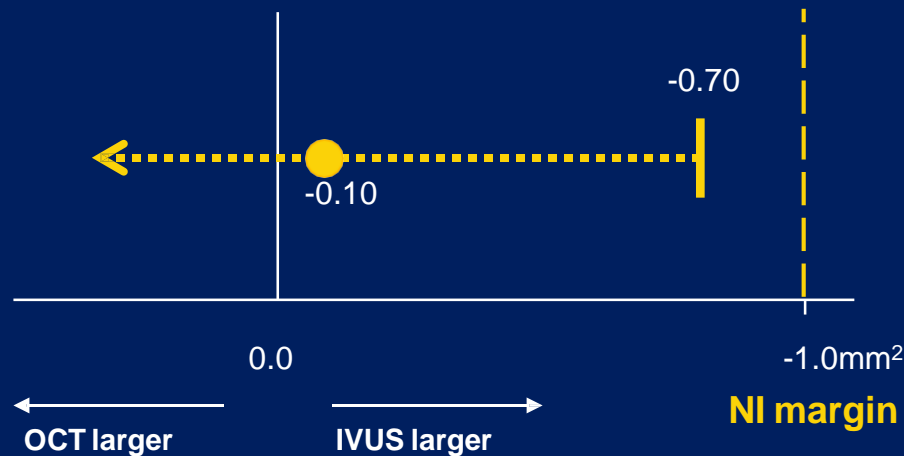

IVUS vs OCT vs Angiography : ILUMIEN III





Outcomes of optical coherence tomography compared with intravascular ultrasound and with angiography to guide coronary stent implantation: one-year results from the ILUMIEN III: OPTIMIZE PCI trial

EuroIntervention 2021;16:1085-1091. DOI: 10.4244/EIJ-D-20-00498



- 450 patients (1:1:1 randomization)
- Non complex lesions
- Primary outcome
 - TLF
 - Composite of death from cardiac causes,
target-vessel-related MI
clinical driven target-vessel revascularization

IVUS vs OCT vs Angiography : ILUMIEN III

OCT- Versus IVUS- and Angiography-Guided Coronary Stent Implantation			
PROSPECTIVE, THREE-ARM, SINGLE-BLIND, MULTICENTER, RANDOMIZED TRIAL			
 431 Patients undergoing PCI of non-complex lesions	OCT-Guided	IVUS-Guided	Angio-Guided
	 N=153	 N=136	 N=142
Target lesion failure at 12 months	2.0%	3.7%	1.4%
OCT vs IVUS: P=0.54; OCT vs Angiography: 0.94			
MACE	9.8%	9.1%	7.9%
In this underpowered study, OCT-guided PCI did not show a significant difference in clinical outcomes at 1 year			

No Significant difference

The OPINION RCT: Design

Prospective, multi-center (n=42), randomized (1:1), non-inferiority trial comparing OCT-guided PCI with IVUS-guided PCI

Patients scheduled for PCI using DES*
n = 800

1:1

OCT-guided PCI
n = 400

*DES: NOBORI
biolimus-eluting stent

IVUS-guided PCI
n = 400

8 months: Follow-up coronary angiography

12 months: Clinical follow-up

Primary Endpoint: Target Vessel Failure (TVF) at 12 months after PCI

RCT: OPINION Trial: OCT vs. IVUS

1-Year TVF (Cardiac Death, TV-MI, or ID-TVR)

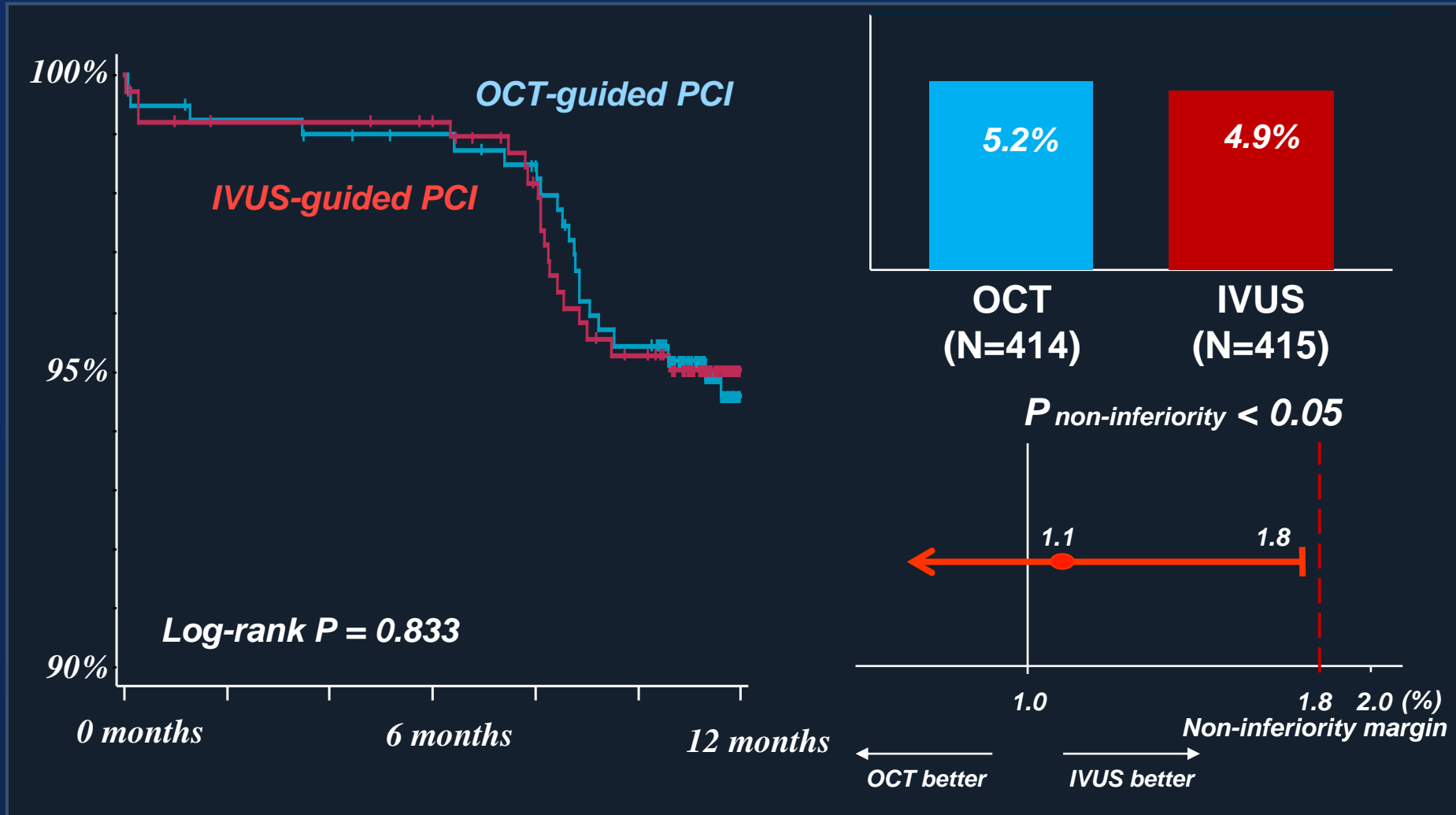

MISTIC-1 RCT: Design

Prospective, multi-center, randomized (1:1), non-inferiority trial comparing OCT-guided PCI with IVUS-guided PCI

Patients scheduled for PCI using DES*
Jun 2014 – Aug 2016, n = 109

1:1

OCT-guided PCI
n = 54

*DES: NOBORI
biolimus-eluting stent

IVUS-guided PCI
n = 55

8 months: Follow-up coronary angiography

36 months: Clinical follow-up

Primary Endpoint: In-segment MLA by OCT at 8 months

Exclusion:

- ACS within 7 days
- Lesion Length >28mm
- LM disease
- CTO
- Bifurcation requiring SB treatment
- Severely calcified lesion
- In-stent restenosis
- LV EF <30%
- eGFR <45ml/min

RCT: MISTIC-1: OCT vs. IVUS

8-month In-segment MLA

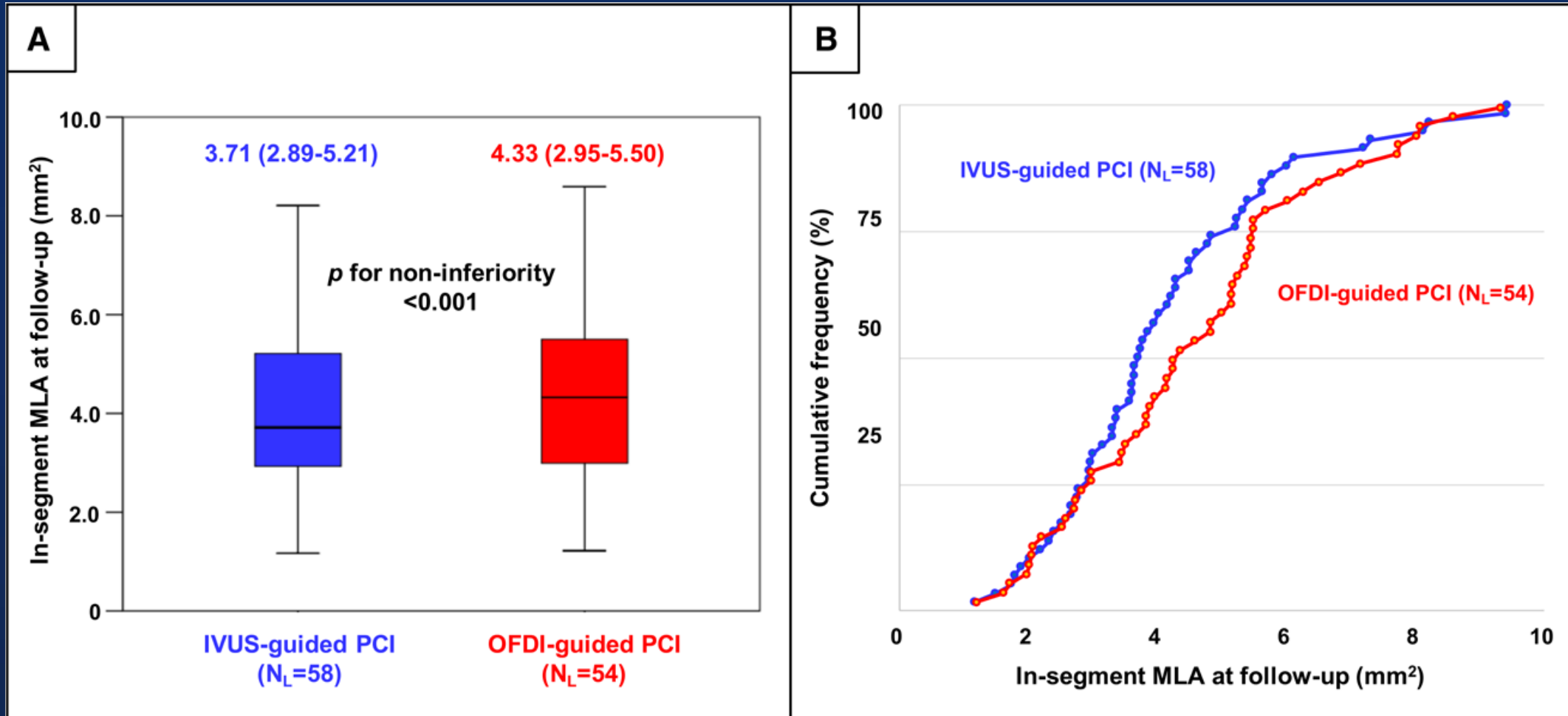

RCT: MISTIC-1: OCT vs. IVUS

36-month Clinical Outcomes

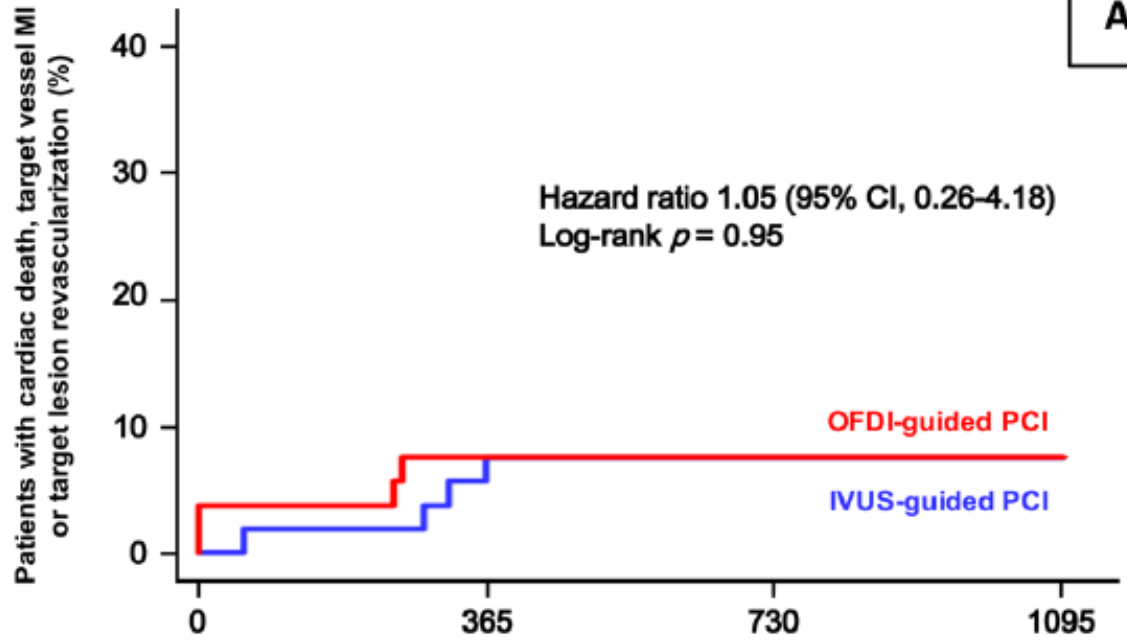

Patients at risk, n

Time since randomization (days)	0	365	730	1095
IVUS	55	49	48	47
OFDI	54	48	45	44

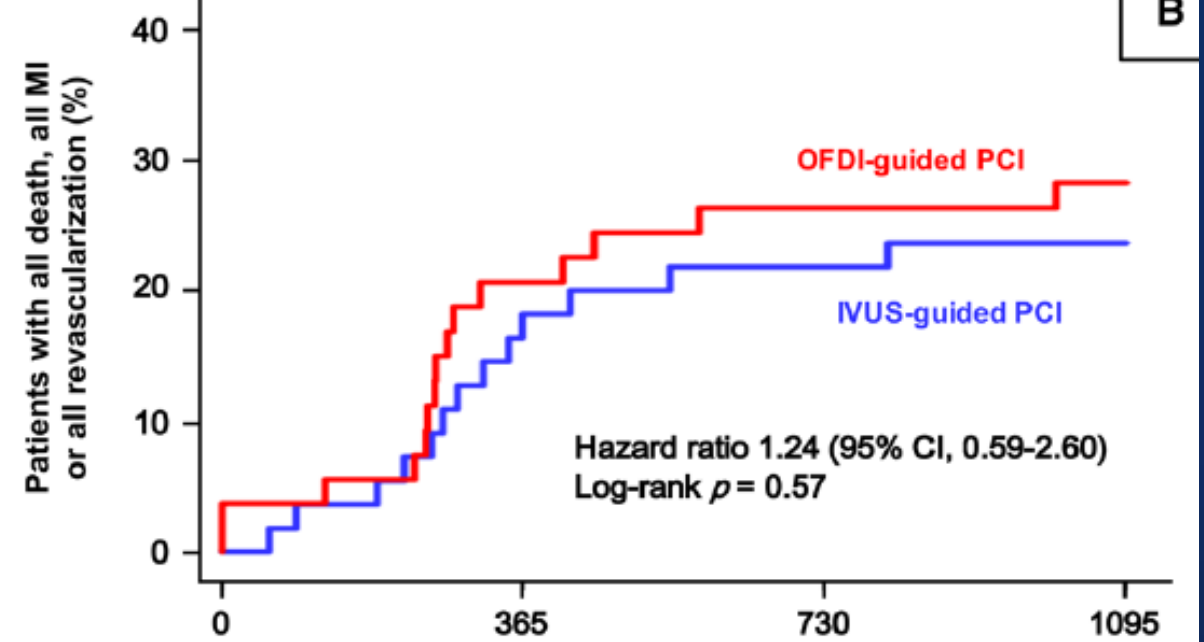

Patients at risk, n

Time since randomization (days)	0	365	730	1095
IVUS	55	45	43	42
OFDI	54	42	39	37

Limitations of Prior RCTs

- **ILUMIEN III**
 - Not powered to detect clinical endpoint
 - Vessel diameter limited to 2.25-3.5 mm, length <40mm
 - **Complex lesions excluded**
(LM, RCA os, graft, CTO, ISR, planned 2-stent bifurcation)
- **OPINION**
 - **Complex lesions excluded**
(LM or 3VD, ostial lesion, CTO, ISR, bypass graft)

OCTIVUS Trial

Pragmatic RCT Comparing OCT vs. IVUS-guided PCI

Optical Coherence Tomography versus Intravascular Ultrasound
Guided Percutaneous Coronary Intervention

OCTIVUS Trial

Patients with CAD undergoing PCI (N=2,000)

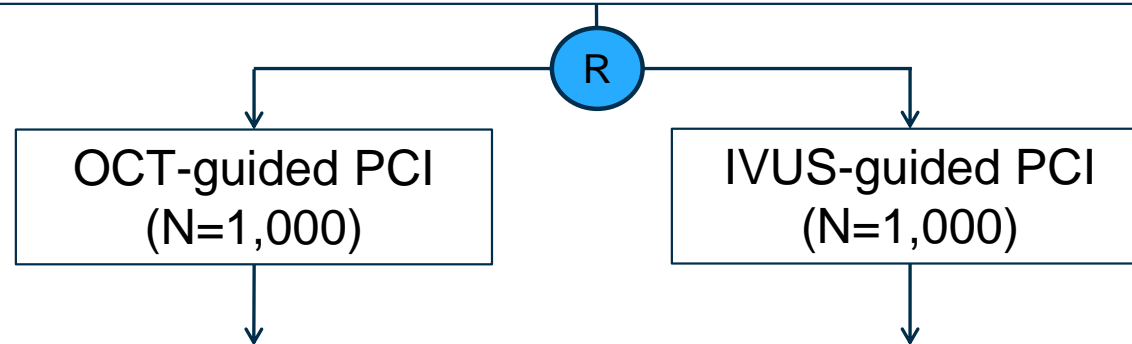

Primary Endpoint: Target Vessel Failure at 1 year
(Composite of cardiac death, target-vessel MI and ischemia-driven TVR)

Clinical follow-up at 1, 6, 12 months, then 3 and 5 years

PI:
Seung-Jung Park, MD.
Duk-Woo Park, MD.

Study Participants

- Inclusion Criteria

- Patients at least 19 years of age
- Subjects with coronary artery disease undergoing PCI

- Exclusion Criteria

- ST-elevation myocardial infarction
- Acute or chronic kidney disease (eGFR <30 ml/min/1.73 m²) without hemodialysis
- Cardiogenic shock or decompensated HF c severe LV dysfunction (LV EF $<30\%$)
- Life expectancy < 1 year

Primary Endpoint

- Target Vessel Failure at 1 year
 - A composite of Cardiac Death, Target Vessel-related MI, and Ischemia-driven Target Vessel Revascularization
 - Periprocedural MI by SCAI definition
- Hypothesis: OCT would be non-inferior to IVUS

OCTIVUS Trial

Pragmatic RCT Comparing OCT vs. IVUS-guided PCI

Optical Coherence Tomography versus Intravascular Ultrasound
Guided Percutaneous Coronary Intervention

OCTIVUS Trial

Patients with CAD undergoing PCI (N=2,000)

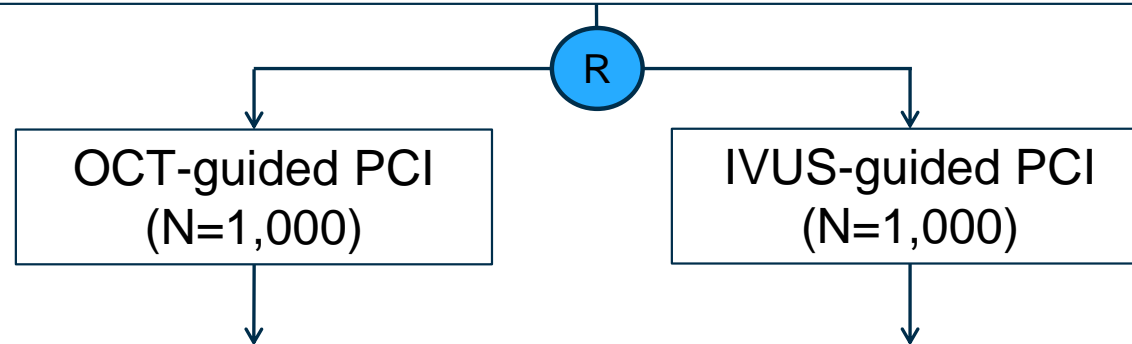

Primary Endpoint: Target Vessel Failure at 1 year
(Composite of cardiac death, target-vessel MI and ischemia-driven TVR)

Clinical follow-up at 1, 6, 12 months, then 3 and 5 years

PI:
Seung-Jung Park, MD.
Duk-Woo Park, MD.

OCTIVUS Trial

Pragmatic RCT Comparing OCT vs. IVUS-guided PCI

Primary Endpoint

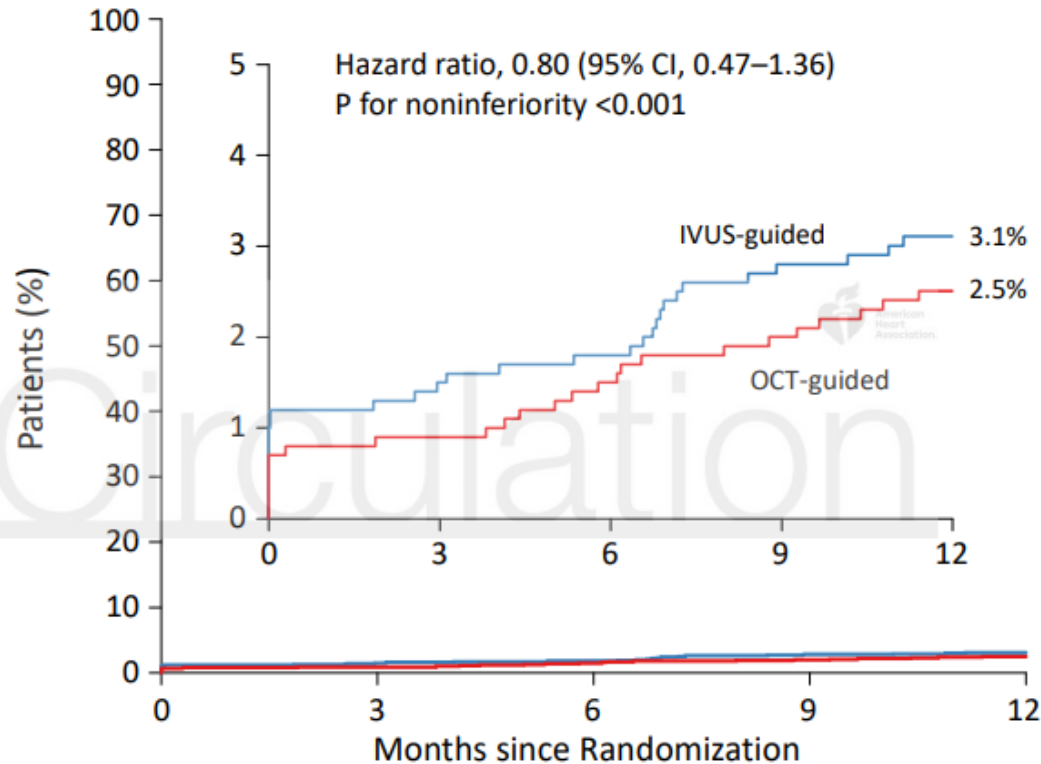

Downloaded from <https://ahajournals.org> by on September 24, 2023

No. at Risk	0	3	6	9	12
OCT-guided PCI	1005	990	984	979	912
IVUS-guided PCI	1003	985	981	969	893

- 2008 patients
- OCT-guided PCI vs IVUS-guided PCI
- DES implantation

Primary outcome

→ TVF at 1 years

(cardiac death, TVMI, ischemia-driven TLR)

OCT

Optical coherence tomography imaging during percutaneous coronary intervention impacts physician decision-making: ILUMIEN I study

William Wijns^{1*}, Junya Shite², Michael R. Jones³, Stephen W.-L. Lee⁴, Matthew J. Price⁵, Franco Fabbiocchi⁶, Emanuele Barbato¹, Takashi Akasaka⁷, Hiram Bezerra⁸, and David Holmes⁹

A prospective, non-randomized study to see the impact of OCT on physician decision-making, post-PCI residual ischemia, and clinical outcomes

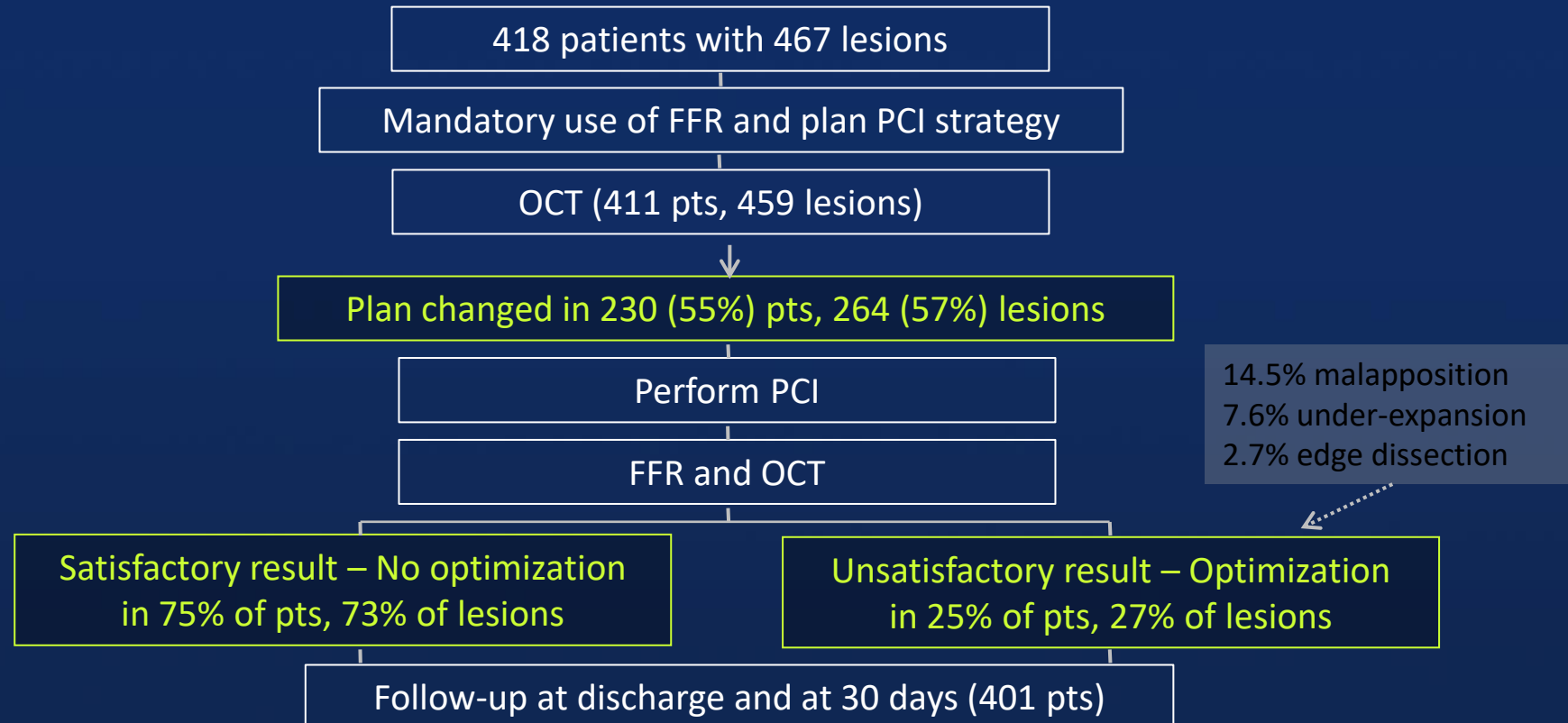

ILUMIEN I study

	PCI optimiz, without change	PCI optimiz based on pre- PCI OCT	PCI optimiz, based on post- PCI OCT	PCI optimiz, based on pre- and post-PCI OCT	p
Pre-PCI FFR	0.72±0.14	0.73±0.14	0.72±0.14	0.72±0.14	0.93
Post-PCI FFR	0.89±0.07	0.89±0.07	0.89±0.08	0.86±0.09	0.003
Final FFR			0.90±0.10	0.90±0.10	0.24
In-hos MACE	8.8%	6.7%	12.2%	1.5%	0.118
1-mo MACE	8.8%	8%	12.5%	1.5%	0.127

- Following OCT-guided PCI, the rates of MACEs at 30 days were very low (death 0.25%, MI 7.7%, TLR 1.7%, ST 0.25%)
- Physician decision-making was affected by OCT imaging prior to PCI in 57% and post-PCI in 27% of all cases

Wijins et al. *Eur heart j*, 2015

ILUMIEN II study

Comparison of Stent Expansion Guided by Optical Coherence Tomography Versus Intravascular Ultrasound



The ILUMIEN II Study (Observational Study of Optical Coherence Tomography [OCT] in Patients Undergoing Fractional Flow Reserve [FFR] and Percutaneous Coronary Intervention)

Akiko Maehara, MD,*† Ori Ben-Yehuda, MD,*† Ziad Ali, MD,*† William Wijns, MD, PhD,‡ Hiram G. Bezerra, MD,§ Junya Shite, MD,|| Philippe Généreux, MD,*†¶ Melissa Nichols, MS,† Paul Jenkins, PhD,† Bernhard Witzenbichler, MD,# Gary S. Mintz, MD,† Gregg W. Stone, MD*†

Design: A post-hoc analysis of the outcome of OCT- vs. IVUS-guided PCI from the ILUMIEN I and ADAPT-DES

Aim: To compare a degree of stent expansion achieved by OCT- vs. IVUS-guidance

Primary endpoint: Final post-PCI stent expansion defined as the MSA divided by the mean of the proximal and distal RLA

Maehara A. J Am Coll Cardiol Intv 2015;8:1704–14

ILUMIEN II study

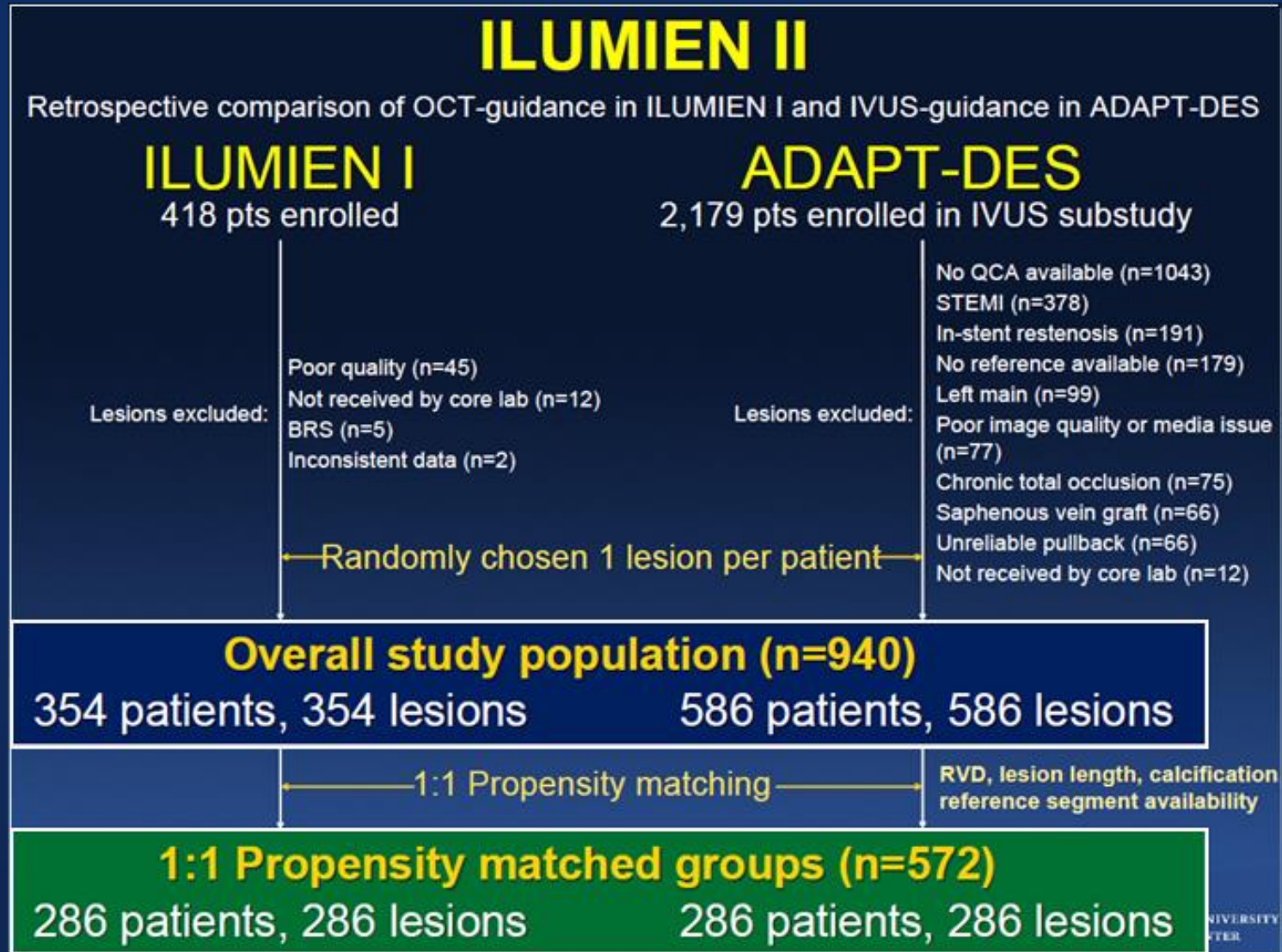

ILUMIEN II study

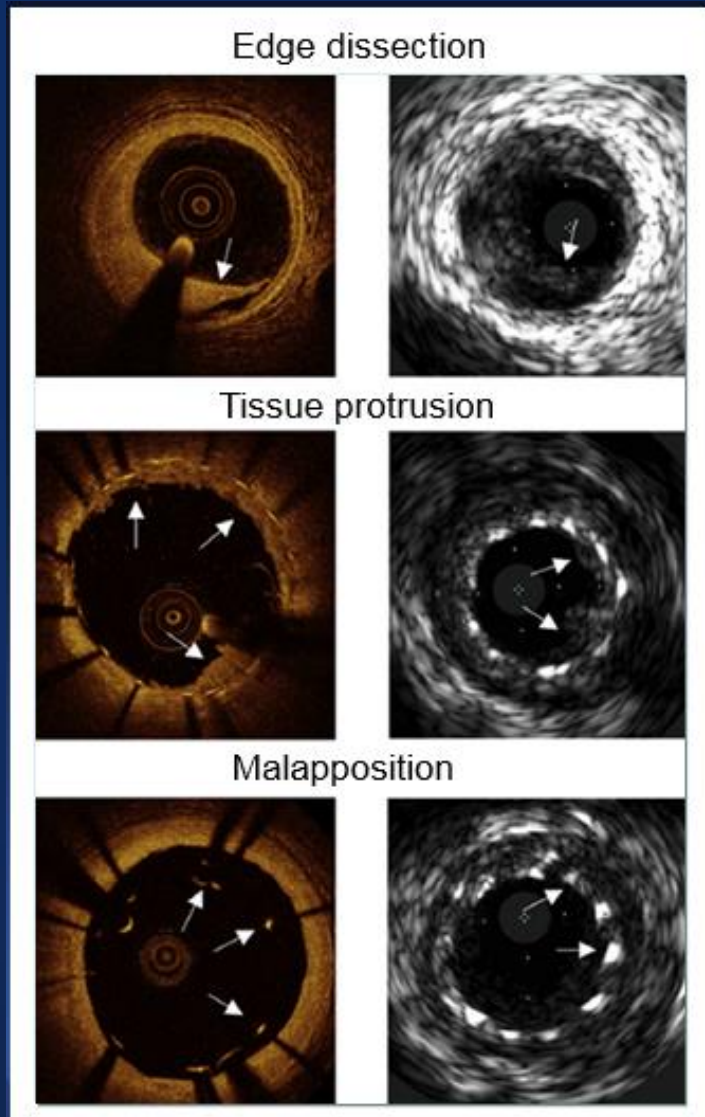

Qualitative Data in the Propensity-Matched Groups

	OCT	IVUS	p
Any <u>malapposition</u>	27%	14%	0.002
<u>distance/MLD</u> >20%	1%	1%	0.69
Any tissue protrusion	64%	27%	<0.001
protrusion CSA>10%	12%	8%	0.17
Any edge dissection	23%	5%	<0.001
<u>dissec</u> length \geq 3mm	2%	1%	0.29

Meahara A. *J Am Coll Cardiol Intv* 2015;8:1704–14

ILUMIEN II study

TABLE 5 Multivariable Analysis in the Entire Study Population (N = 940)

	Endpoints			
	Stent Expansion, %	Mean Stent Expansion, %	Diameter Stenosis In-Stent, %	Diameter Stenosis In-Segment, %
Measurement by OCT (N = 354)	72.6 (63.5, 81.4)	89.6 (79.2, 98.5)	6.4 (2.7, 9.9)	13.3 (8.9, 20.2)
Measurement by IVUS (n = 586)	70.5 (62.1, 79.5)	86.8 (77.1, 96.8)	6.4 (3.0, 10.7)	11.2 (7.6, 17.2)
	Adjusted p Values			
OCT vs. IVUS	0.84	0.30	0.19	0.009

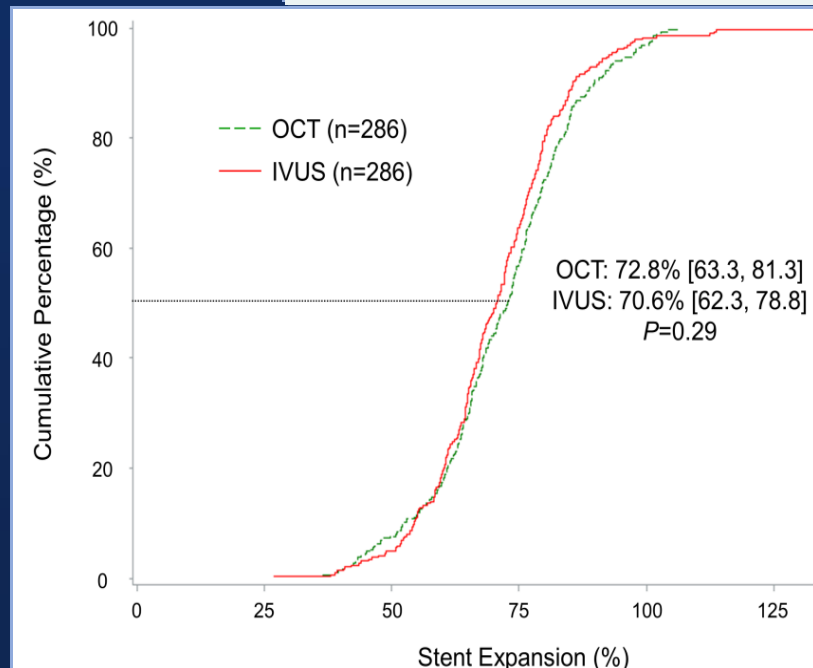

Conclusion

OCT-guidance was related to comparable stent expansion, and similar rates of major edge dissection, stent malapposition, and tissue protrusion as compared to IVUS-guidance

ILUMIEN III : OPTIMIZE PCI

OCT-Guided vs IVUS-Guided vs Angio-Guided PCI

- Randomly allocated 450 patients (1:1:1)
 - OCT guidance ; 158 [35%]
 - IVUS guidance ; 146 [32%]
 - Angiography guidance ; 146 [32%]
- All patients underwent final OCT imaging
- Primary efficacy endpoint ; post-PCI minimum stent area
- Primary safety endpoint ; procedural MACE

ILUMIEN III : OPTIMIZE PCI

OCT-Guided vs IVUS-Guided vs Angio-Guided PCI

Efficacy Endpoints

	OCT (n=140)	IVUS (n=135)	Angio (n=140)	P (OCT vs IVUS)	P (OCT vs Angio)
Minimal stent area(mm ²)	5.79 [4.54-7.34]	5.89 [4.67-7.80]	5.49 [4.39-6.59]	0.42	0.12
Minimum stent expansion(%)	88±17	87±16	83±13	0.77	0.02
Mean stent expansion(%)	106 [98-120]	106 [97-117]	101 [92-110]	0.63	0.001

OCT guidance was non-inferior to IVUS guidance (one-sided 97.5% lower CI -0.70 mm²; $p=0.001$), but not superior ($p=0.42$).

OCT guidance was also not superior to angiography guidance ($p=0.12$).

ILUMIEN III : OPTIMIZE PCI

OCT-Guided vs IVUS-Guided vs Angio-Guided PCI

Primary Safety Endpoints

	OCT (n=158)	IVUS (n=146)	Angio (n=146)	P (OCT vs IVUS)	P (OCT vs Angio)
Procedural MACE(%)	2.5	0.7	0.7	0.37	0.37
Complication					
Dissection(%)	1.3	0.0	0.7	0.50	1.00
Perforation	0.0	0.7	0.0	0.48	-
Thrombus	1.3	0.0	0.0	0.50	0.50
Acute closure	0.6	0.0	0.0	1.00	1.00

Procedural MACE was infrequent and not significantly different between the three groups.

ILUMIEN III : OPTIMIZE PCI

OCT-Guided vs IVUS-Guided vs Angio-Guided PCI

Postprocedure OCT measure

	OCT (n=140)	IVUS (n=135)	Angio (n=140)	P (OCT vs IVUS)	P (OCT vs Angio)
Any dissection(%)	39(28)	53(40)	64(44)	0.04	0.006
Major(%)	19(14)	35(26)	26(19)	0.009	0.25
Minor(%)	20(14)	18(13)	35(25)	0.84	0.02
Any malposition(%)	58(41)	52(39)	83(59)	0.62	0.003
Major(%)	15(11)	28(21)	44(31)	0.02	<0.001
Minor(%)	43(31)	24(18)	39(28)	0.01	0.60

OCT-guided PCI resulted in the fewest untreated major dissection and areas of major stent malapposition.

Post-stent OCT Findings

From MGH OCT registry, 900 lesions in 786 patients with post-stenting OCT were analyzed to identify the OCT predictors for device-oriented clinical end points (cardiac death, target vessel-related MI, TLR and stent thrombosis)

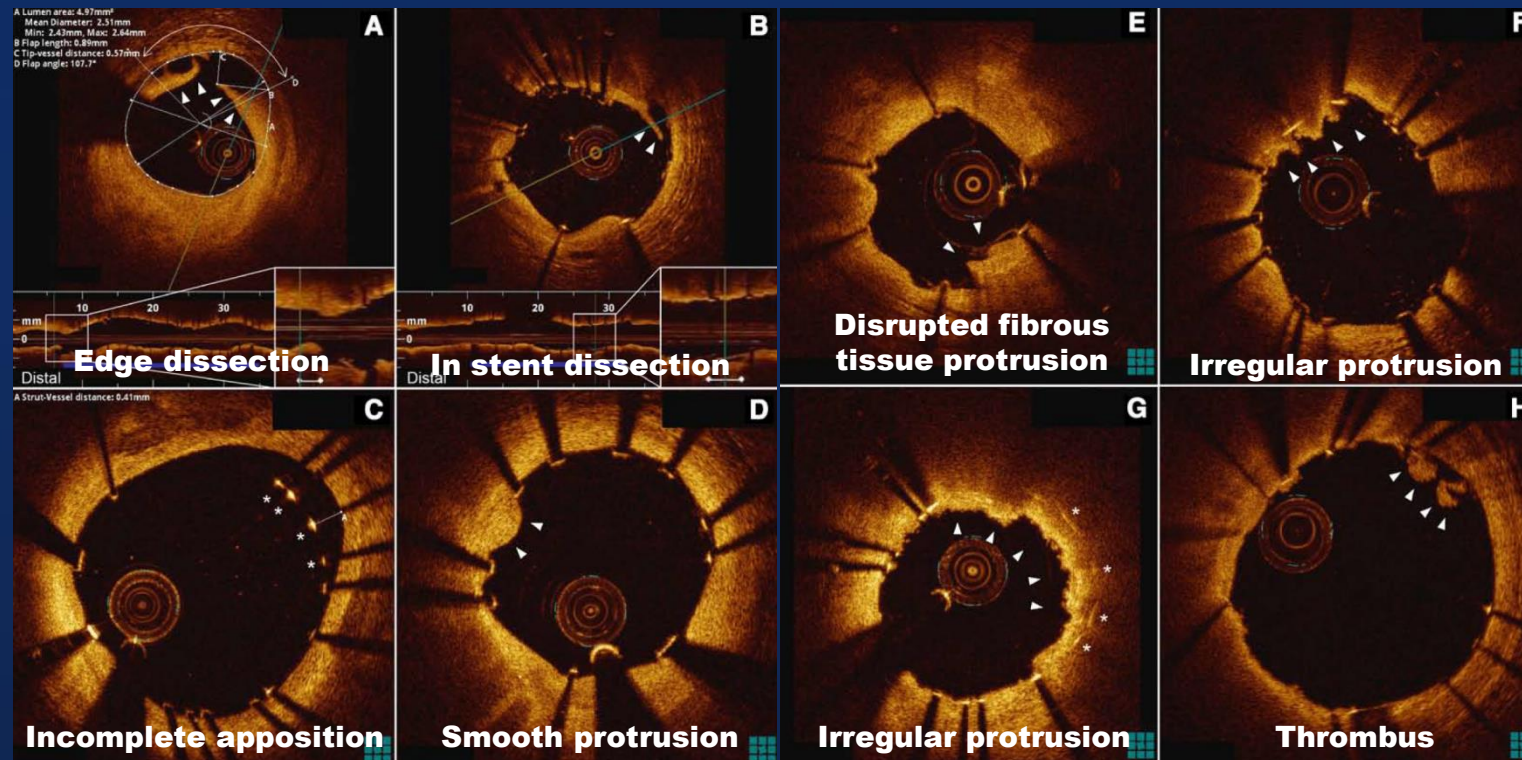

Soeda T, Jang IK et al. *Circulation* 2015;132:1020-9

Post-stent OCT Findings

Incidence of Post-stent Qualitative and Quantitative OCT Findings (Lesion-Level)

	No MACE	MACE	p
N	795	39	
Edge dissection	29%	31%	0.78
Malapposition	38%	36%	0.76
Tissue protrusion	97%	100%	0.63
Irregular protrusion	52%	74%	0.003
Thrombus	38%	51%	0.13
Small MSA*	40%	59%	0.039

*Small MSA : <5.0 mm² for DES and <5.6 mm² for BMS

Soeda T, Jang IK et al. Circulation 2015;132:1020-9

Post-stent OCT Findings

Multivariable Predictors of
Device-oriented MACE and TLR

	MACE		TLR	
	OR (95% CI)	p	OR (95% CI)	p
Age, year	NA		0.98 (0.95-1.02)	
Male	3.13 (0.92-10.69)	0.068	NA	
BMS	1.75 (1.19-2.58)	0.005	1.80 (1.23-2.63)	0.002
Irregular protrusion	2.64 (1.40-5.01)	0.003	2.66 (1.40-5.05)	0.003
Small MSA*	2.54 (1.23-5.25)	0.012	2.54 (1.24-5.21)	0.011

*Small MSA : <5.0 mm² for DES and <5.6 mm² for BMS

Patient-level analysis

Soeda T, Jang IK et al. Circulation 2015;132:1020-9

Post-stent OCT Findings

Rates of Device-oriented MACE and TLR
from multivariable models

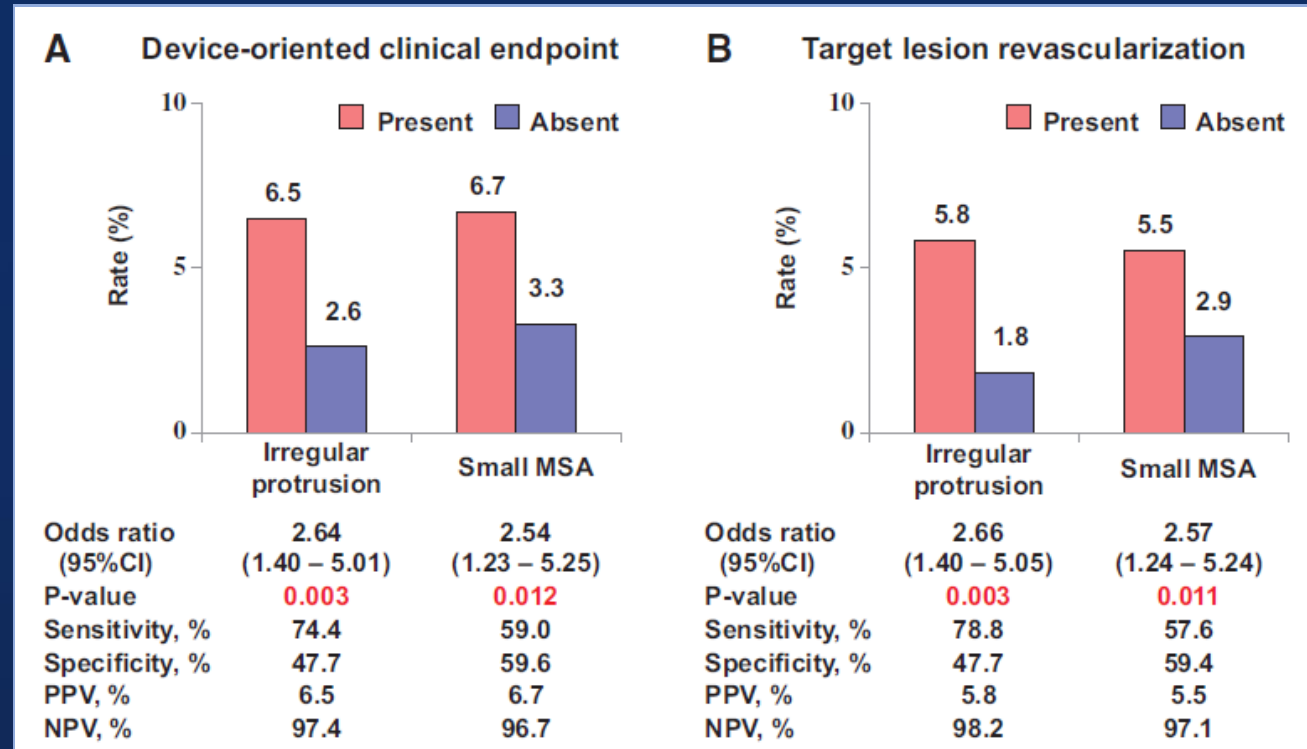

Irregular protrusion and small MSA were the independent OCT predictors of MACE, which were primarily driven by TLR

Soeda T, Jang IK et al. Circulation 2015;132:1020-9

Plaque rupture and prognosis in ACS

Plaque rupture and intact fibrous cap assessed by optical coherence tomography portend different outcomes in patients with acute coronary syndrome

Giampaolo Niccoli^{1*}, Rocco A. Montone¹, Luca Di Vito^{2,3}, Mario Gramegna¹, Hesham Refaat^{1,4}, Giancarla Scalone¹, Antonio M. Leone¹, Carlo Trani¹, Francesco Burzotta¹, Italo Porto¹, Cristina Aurigemma¹, Francesco Prati^{2,3}, and Filippo Crea¹

- To evaluate the prognostic value of plaque rupture vs. intact fibrous cap in 139 ACS patients undergoing PCI
- No differences in clinical, angiographic, or procedural data

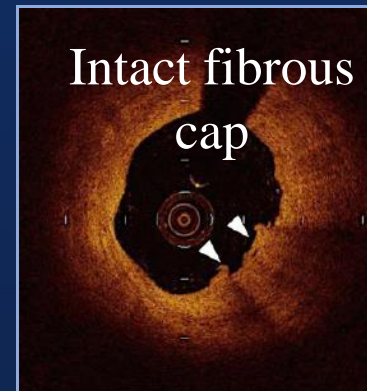
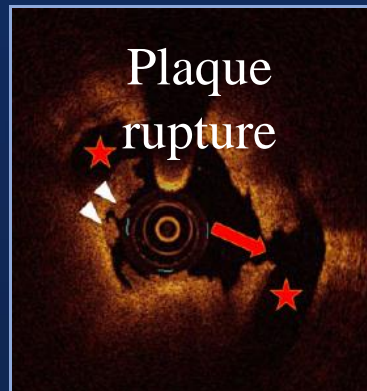

Plaque rupture and prognosis in ACS

MACE rates

Patients with plaque rupture vs. with intact fibrous cap

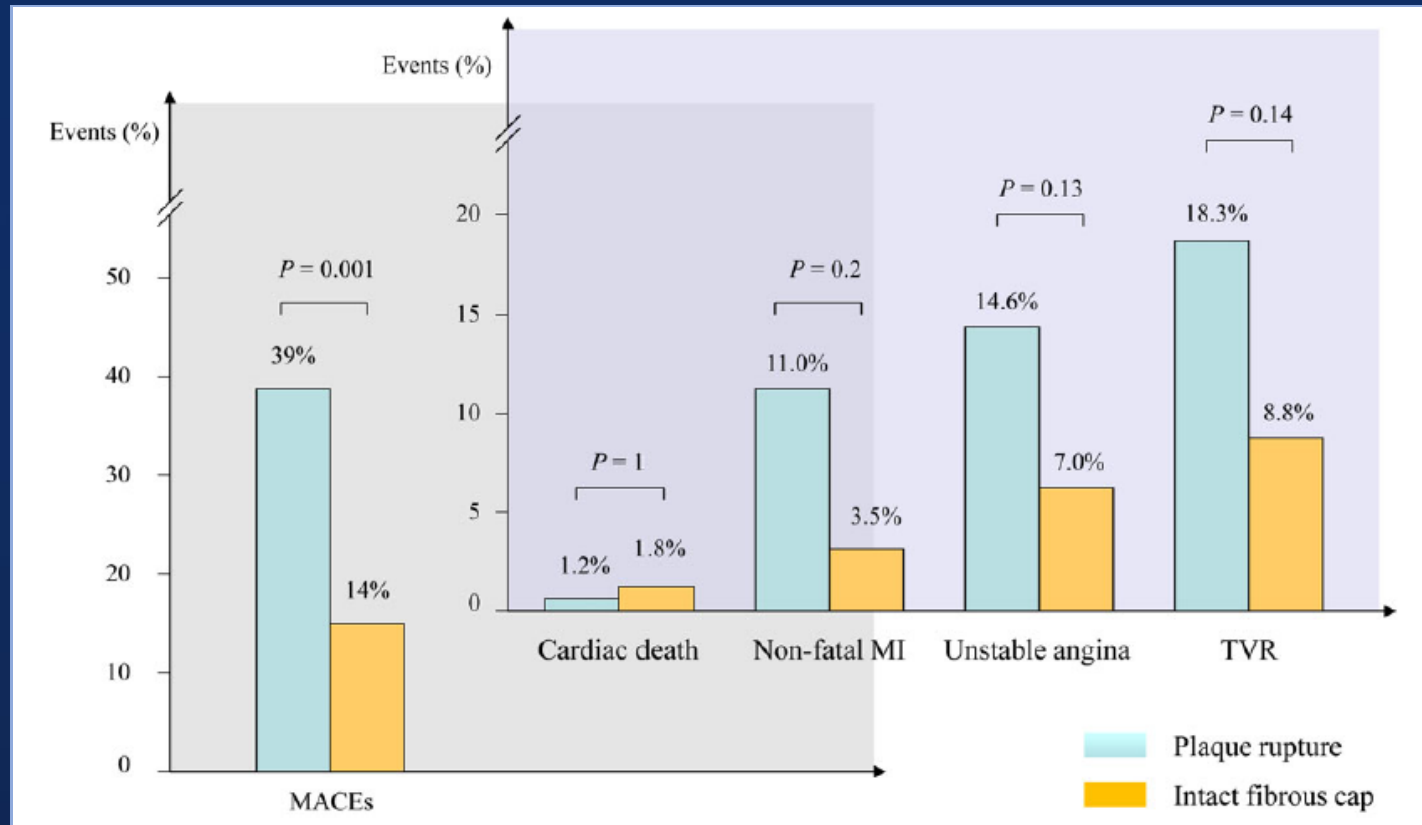

Plaque rupture and prognosis in ACS

Kaplan–Meier Analysis

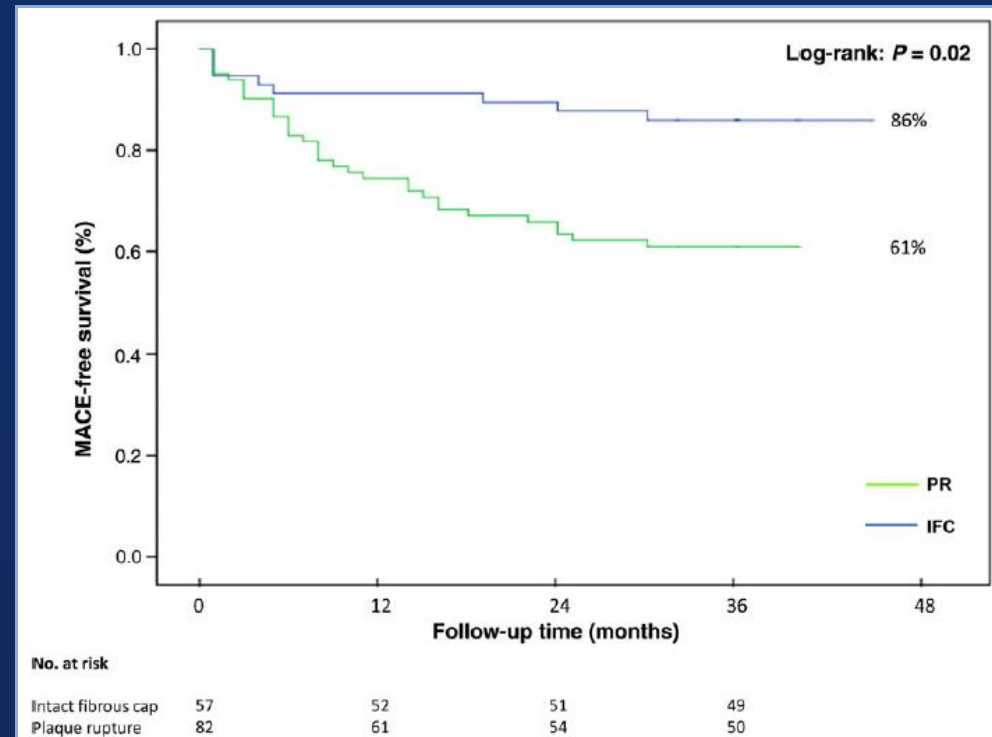

Conclusion

Patients with plaque rupture had a worse MACE-free survival (61% vs. 86%) compared with those having an intact fibrous cap

Plaque rupture and prognosis in ACS

Predictors of 3-year MACEs
Multivariable Cox regression analysis

	HR	95% CI	p
Obesity (BMI >35)	1.688	0.822-3.845	0.15
Plaque rupture	3.735	1.358-9.735	0.010
Previous PCI	1.449	0.610-4.146	0.34
Stent length	1.028	0.980-1.081	0.26
Age	1.005	0.977-1.034	0.73
Male	1.36	0.335-1.591	0.76

Conclusion

ACS patients with plaque rupture in culprit lesion have a worse prognosis compared to those with IFC, which should be taken into account in risk stratification and management of ACS

Stent coverage following OCT vs angio-guided PCI

- RCT
- 101 patients (105 lesions)
- OCT guided PCI (n=51) vs angio-guided PCI (n=54)
- 6 months follow-up OCT
- Primary endpoint : incidence of uncovered struts

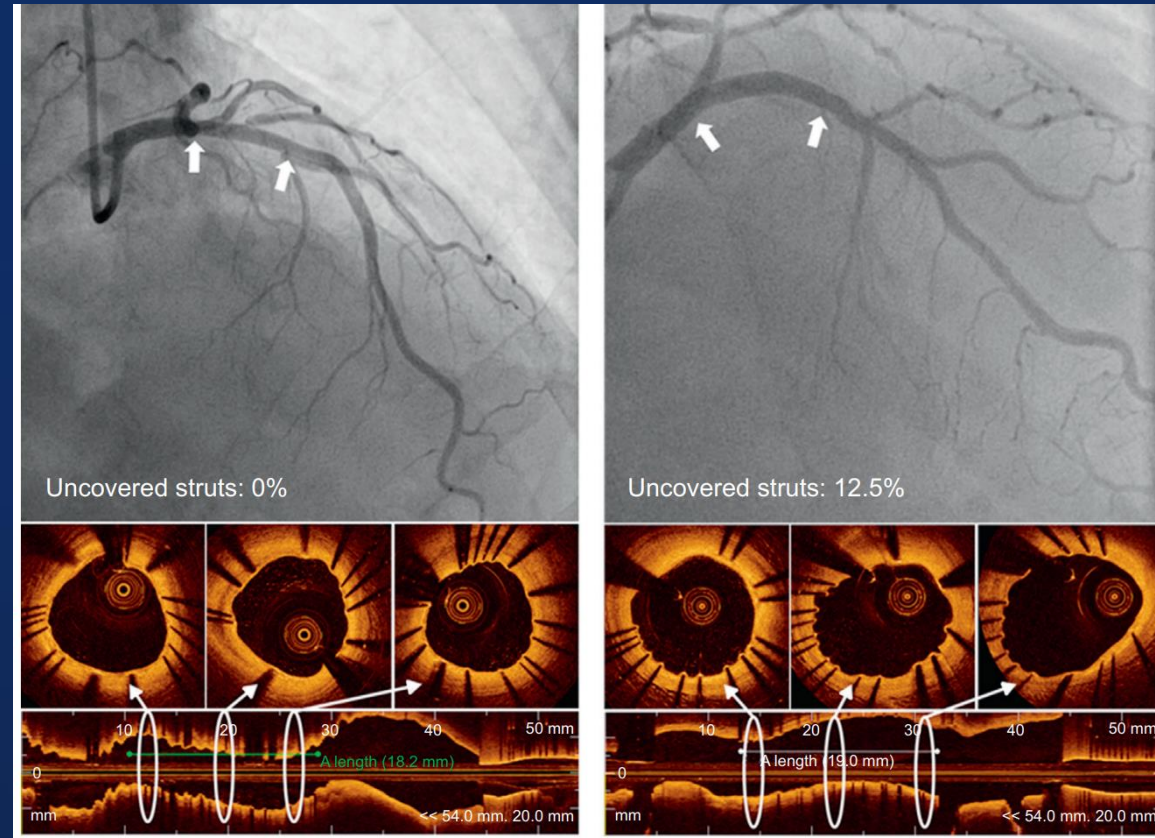

OCT-guided

Angio-guided

Hong et al. *Rev Esp Cardiol (Engl Ed)*. 2015
Mar;68(3):190-7

Stent coverage following OCT vs angio

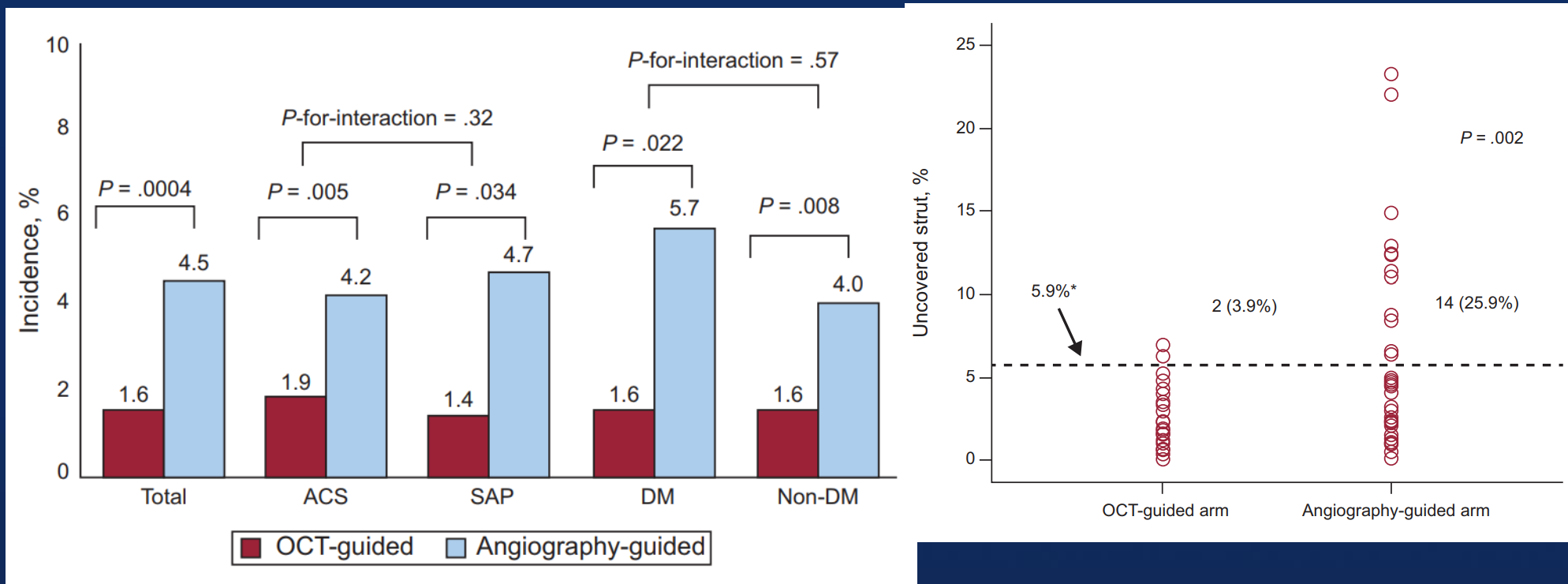

Hong et al. Rev Esp Cardiol (Engl Ed). 2015
Mar;68(3):190-7

OCT guidance vs angiographic guidance

CLI-OPCI study

One year outcome	OCT (n=335)	CAG (n=335)	P
Death	3.3%	6.9%	0.035
Cardiac death	1.2%	4.5%	0.010
MI	5.4%	8.7%	0.096
TLR	3.3%	3.3%	1
Definite ST	0.3%	0.6%	0.6
Cardiac death/MI	6.6%	13.0%	0.006
Cardiac death/MI or repeat revascularization*	9.6%	15.1%	0.034

***Even after accounting for baseline and procedural differences (OR=0.49, p=0.037)**

OCT guidance vs angiographic guidance

DOCTORS study

N=240 (120 vs 120)

Multicenter, prospective, randomized trial

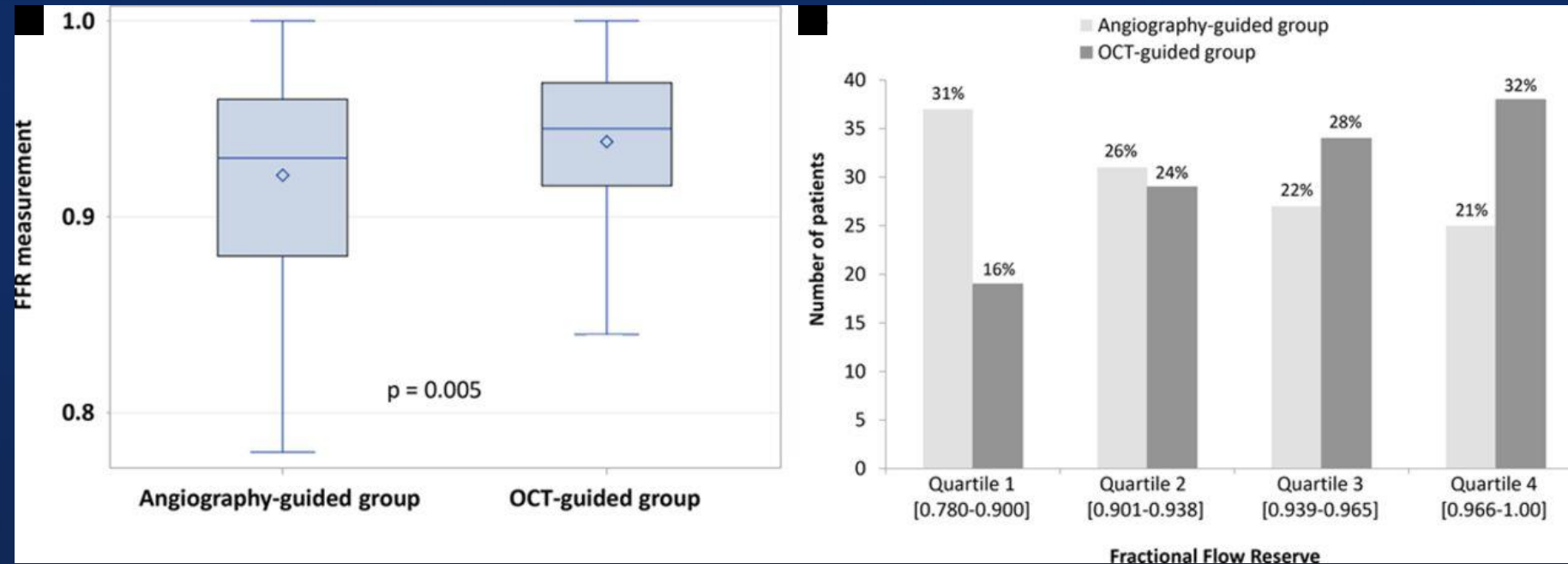

FFR after PCI in the angio vs OCT guided group

OCT guidance vs angiographic guidance

DOCTORS study

Variable	Pre-stenting	Immediately poststenting	Post-OCT optimization	p-value
Reference diameter, mm	2.92±0.53	3.10±0.45	3.11±0.48	0.27
MLD, mm	1.21±0.33	2.79±0.46	2.84±0.43	0.001
Diameter stenosis, %	58.4±10.9	9.5±6.1	8.4±3.9	<0.0001
Reference area, mm	7.0±2.23	7.62±2.42	7.72±2.43	0.10
MLA, mm ²	1.28±0.71	5.99±2.11	6.41±1.99	<0.0001
Area stenosis, %	81.1±9.82	21.1±12.4	15.9±7.3	<0.0001

OCT vs Angiographic guidance

EROSION III

226 STEMI Patient with early infarct patency

R
1:1

OCT Guided (n=112)

Angio Guided (n=114)

OCT guided reperfusion was associated with less stent implantation during primary PCI

■ Stenting ■ Nonstenting

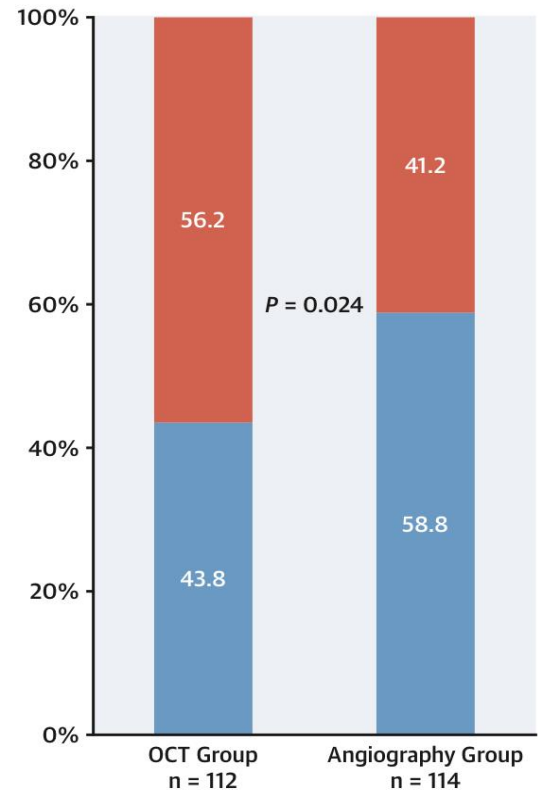
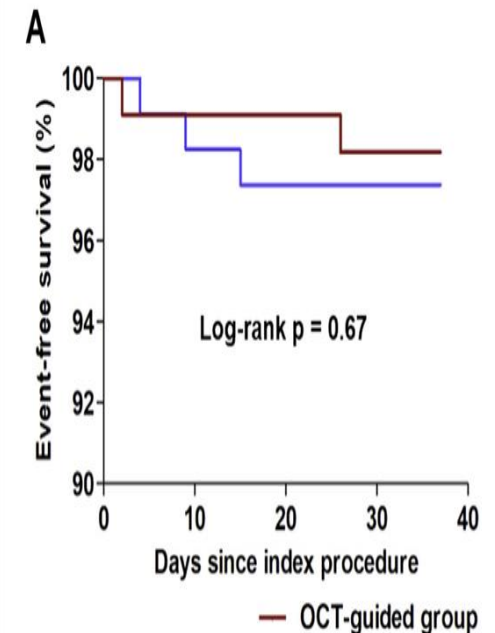

FIGURE 3 Primary Safety Endpoint



Survival rate of primary safety endpoint (A) and cardiac death (B). Abbr

OCT guidance vs Angiographic guidance

EROSION III

One year outcome	OCT (n=335)	CAG (n=335)	P
Death	3.3%	6.9%	0.035
Cardiac death	1.2%	4.5%	0.010
MI	5.4%	8.7%	0.096
TLR	3.3%	3.3%	1
Definite ST	0.3%	0.6%	0.6
Cardiac death/MI	6.6%	13.0%	0.006
Cardiac death/MI or repeat revascularization*	9.6%	15.1%	0.034

***Even after accounting for baseline and procedural differences (OR=0.49, p=0.037)**

OCT guidance vs Angiographic guidance

ILUMIEN IV

ORIGINAL ARTICLE

Optical Coherence Tomography–Guided versus Angiography-Guided PCI

- 2487 patients (80 sites in 18 countries)
- OCT-guided PCI vs angiography-guided PCI

Primary outcome

→ minimum stent area after PCI

→ Target vessel failure

(composite of cardiac cause, TVMI,
or ischemia-driven TVR)

ILUMIEN IV : OPTIMIZE PCI

OCT-Guided vs Angio-Guided PCI

Prospective, randomized, single-blind trial
comparing OCT-guided PCI with Angio-guided PCI

Inclusion:

- DM
- Lesion Length >28mm
- MV
- CTO
- Bifurcation requiring SB treatment
- Severely calcified lesion
- In-stent restenosis

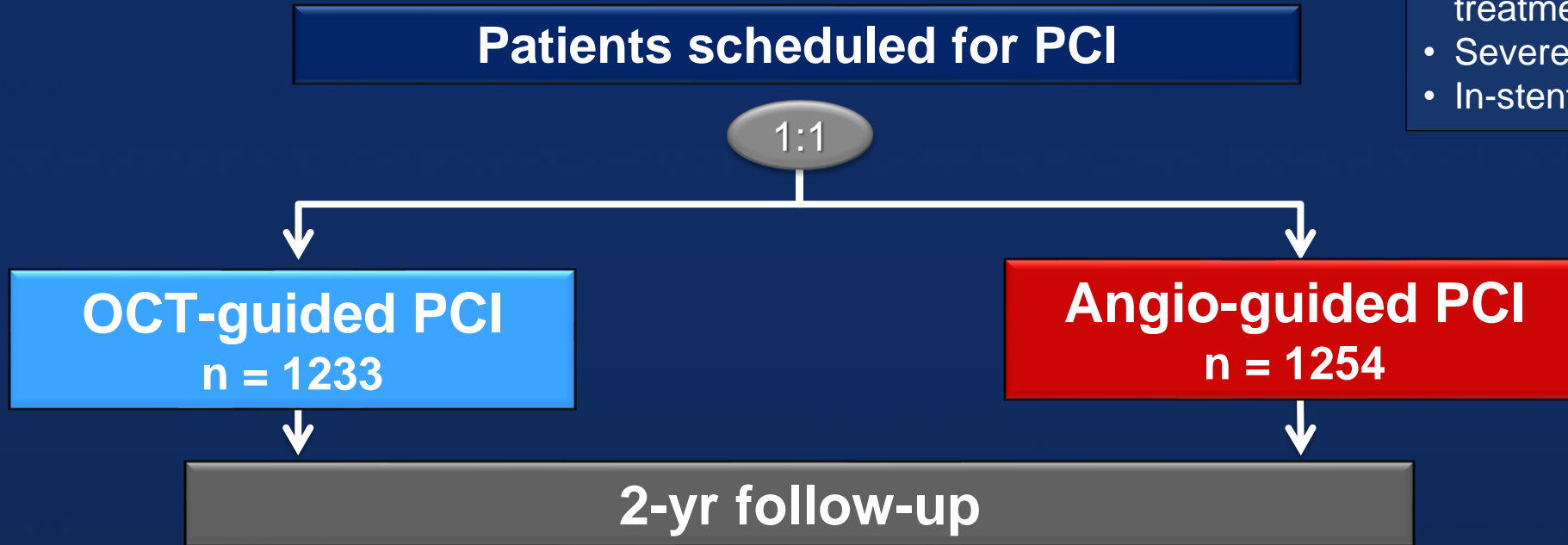

Primary Endpoint:

Minimum stent area after PCI

Target vessel failure (composite of cardiac cause, TVMI, or ischemia-driven TVR)

ILUMIEN IV : OPTIMIZE PCI

OCT-Guided vs Angio-Guided PCI

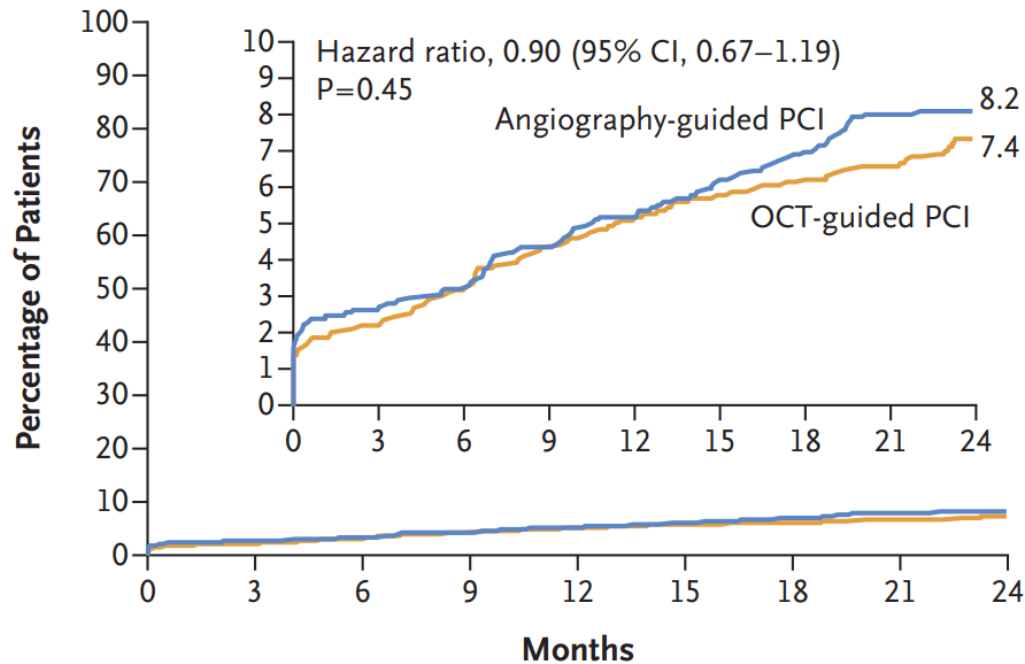

No Significant difference

No. at Risk

Angiography-guided PCI	1254	1195	1184	1168	1143	1108	1092	1070	573
OCT-guided PCI	1233	1187	1174	1157	1127	1096	1085	1077	560

Figure 2. Patients with Target-Vessel Failure.

OCT guidance vs Angiographic guidance

RENOVATE-COMPLEX

- 1639 patients (2:1 randomization)
- Complex coronary anatomy
 - : true bifurcation lesions, CTO, LM disease, long lesions with more than 38 mm length, MV, ISR, severely calcified lesion; or ostial lesions of a major epicardial coronary artery
- Primary outcome
 - Composite of death from cardiac causes,
target-vessel-related MI
clinical driven target-vessel revascularization

OCT guidance vs Angiographic guidance

RENOVATE-COMPLEX

A Target-Vessel Failure

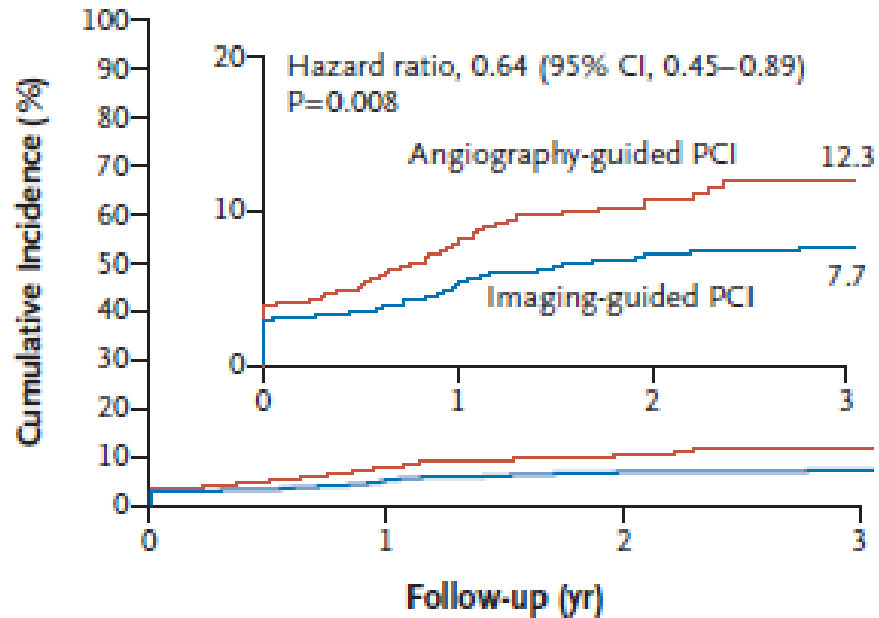

No. at Risk

Angiography-guided PCI	547	496	280	120
Imaging-guided PCI	1092	1023	591	255

B Target-Vessel Failure without Procedure-Related Myocardial Infarction

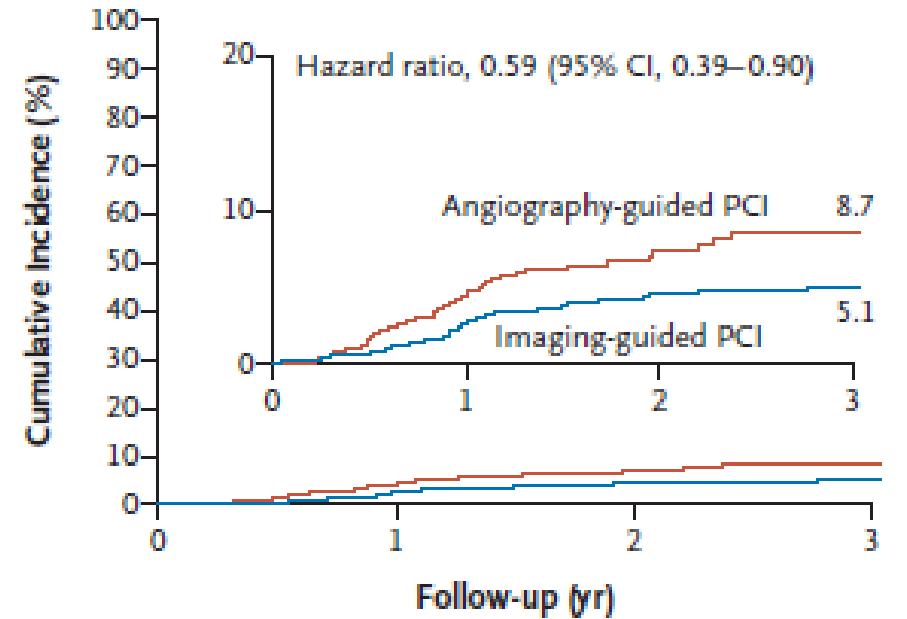

No. at Risk

Angiography-guided PCI	547	516	284	121
Imaging-guided PCI	1092	1051	596	256

OCT guidance vs Angiographic guidance

OCTOBER

ORIGINAL ARTICLE

OCT or Angiography Guidance for PCI in Complex Bifurcation Lesions

- 1201 patients (38 centers in Europe)
- OCT-guided PCI vs angiography-guided PCI
- PCI and complex bifurcation lesion

Primary outcome

→ MACE at 2 years

(cardiac death, TLMI, ischemia-driven TLR)

OCT guidance vs Angiographic guidance

OCTOBER

1201 patients with SA, UA, NSTEMI



Primary outcome
MACE (death from cardiac cause, TLMI, TVR) at a
median follow-up of 2 years

OCT guidance vs Angiographic guidance

OCTOBER

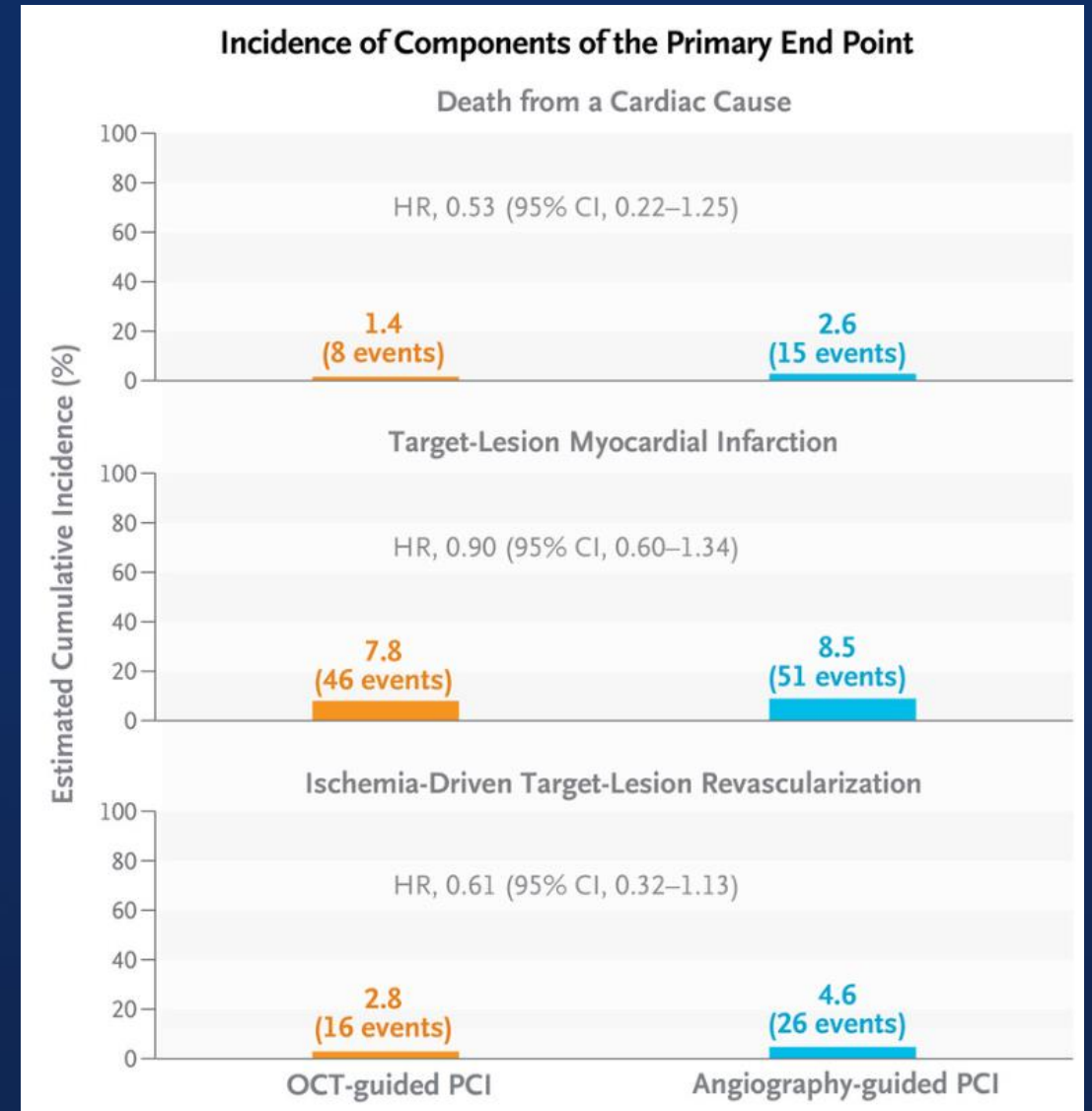
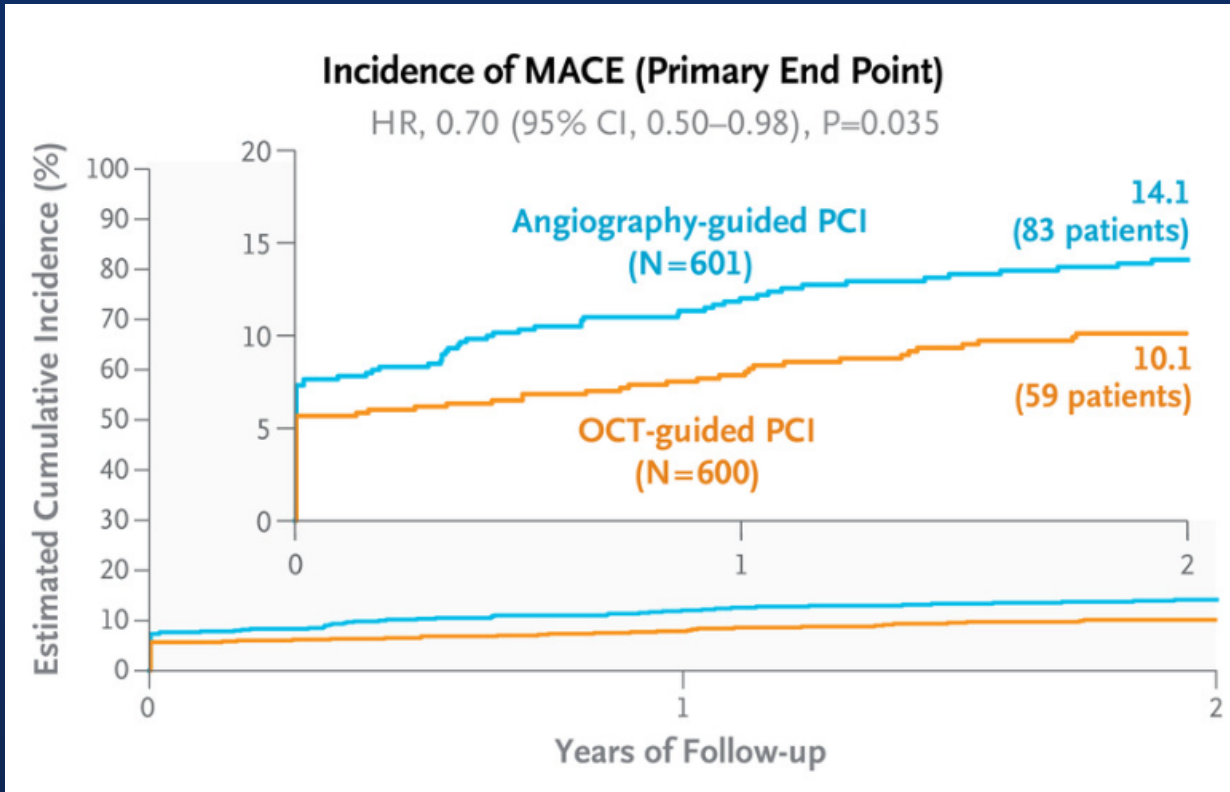

OCT guidance vs Angiographic guidance

OCTOBER

	OCT (n=600)	CAG (n=601)	HR (95% CI)
Primary end point: MACE	10.1%	14.1%	0.70 (0.50-0.98)
Clinical secondary end points			
Patient-oriented composite end point	13.6%	17.7%	0.76 (0.56-1.01)
Death from any cause	2.4%	4.0%	0.56 (0.28-1.10)
Death from a cardiac cause	1.4%	2.6%	0.53 (0.22-1.25)
Target-lesion myocardial infarction	7.8%	8.5%	0.90 (0.60-1.34)
Ischemia-driven target-lesion revascularization	2.8%	4.6%	0.61 (0.32-1.13)
Stent thrombosis	2.1%	3.0%	0.70 (0.34-1.47)

OCT guided PCI



Stent underexpansion

PLUS...

(Minor) findings not seen on IVUS

Malapposition

Tissue protrusion

Edge dissection

Stent underexpansion

PLUS...

Geographical miss
(major edge dissections,
Plaque burden >50%)

Characteristics of devices

	IVUS	OCT
Energy source	US	NIR laser
Resolution	100-200 um	10-20 um
Frame rate	30 fps	160 fps
Pullback velocity	0.5-2.0 mm/sec	0.5-40 mm/sec
Catheter type	RX 2.4 Fr	RX 2.4 Fr
Penetration depth	5 mm	1-2 mm
Scan diameter	20 mm	10 mm
Blood evacuation	-	Lactate Ringer and/or Contrast medium flush

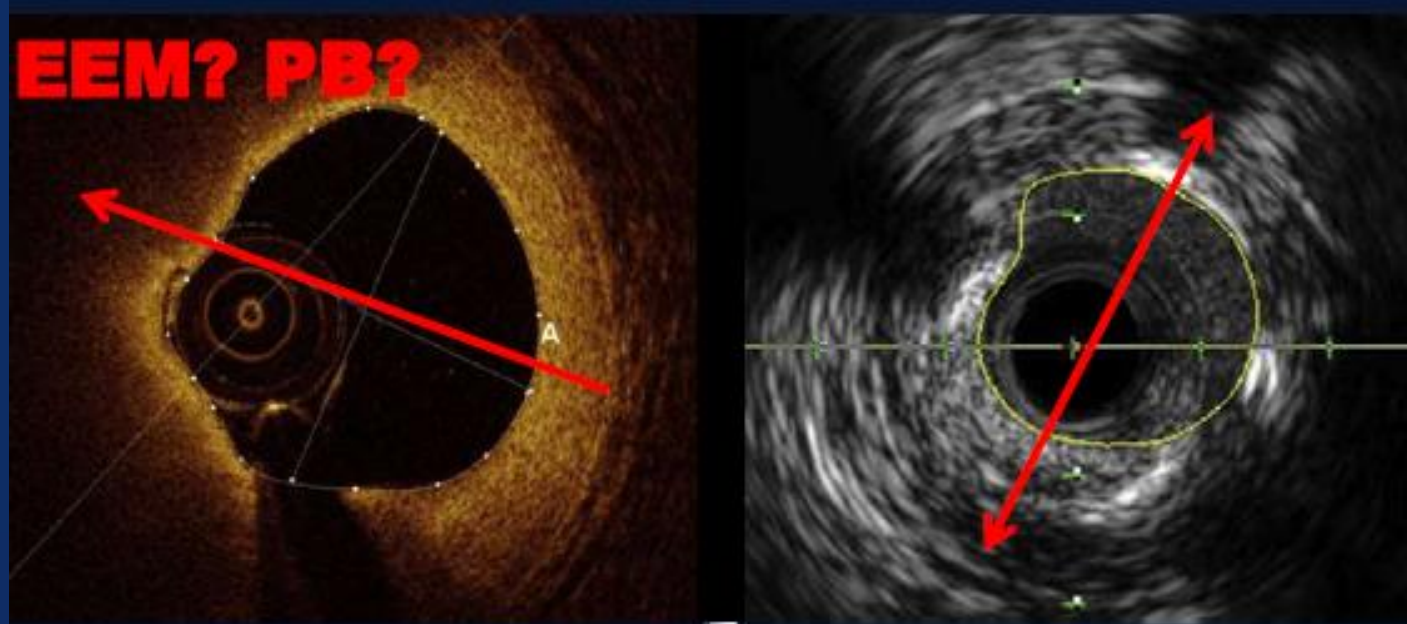

Ability to Detect Suboptimal Findings (OPUS-CLASS)

Post-PCI	IVUS	OCT	P
Malapposition	14%	39%	< 0.001
Tissue protrusion	18%	95%	< 0.001
Dissection	0%	13%	0.013
Thrombus	0%	13%	0.013

IVUS vs OCT guided PCI

OPINION Trial

- Multicenter, Prospective, Randomized trial
- Optical frequency domain imaging (OFDI) vs IVUS
- Primary endpoint : target vessel failure within 12 months

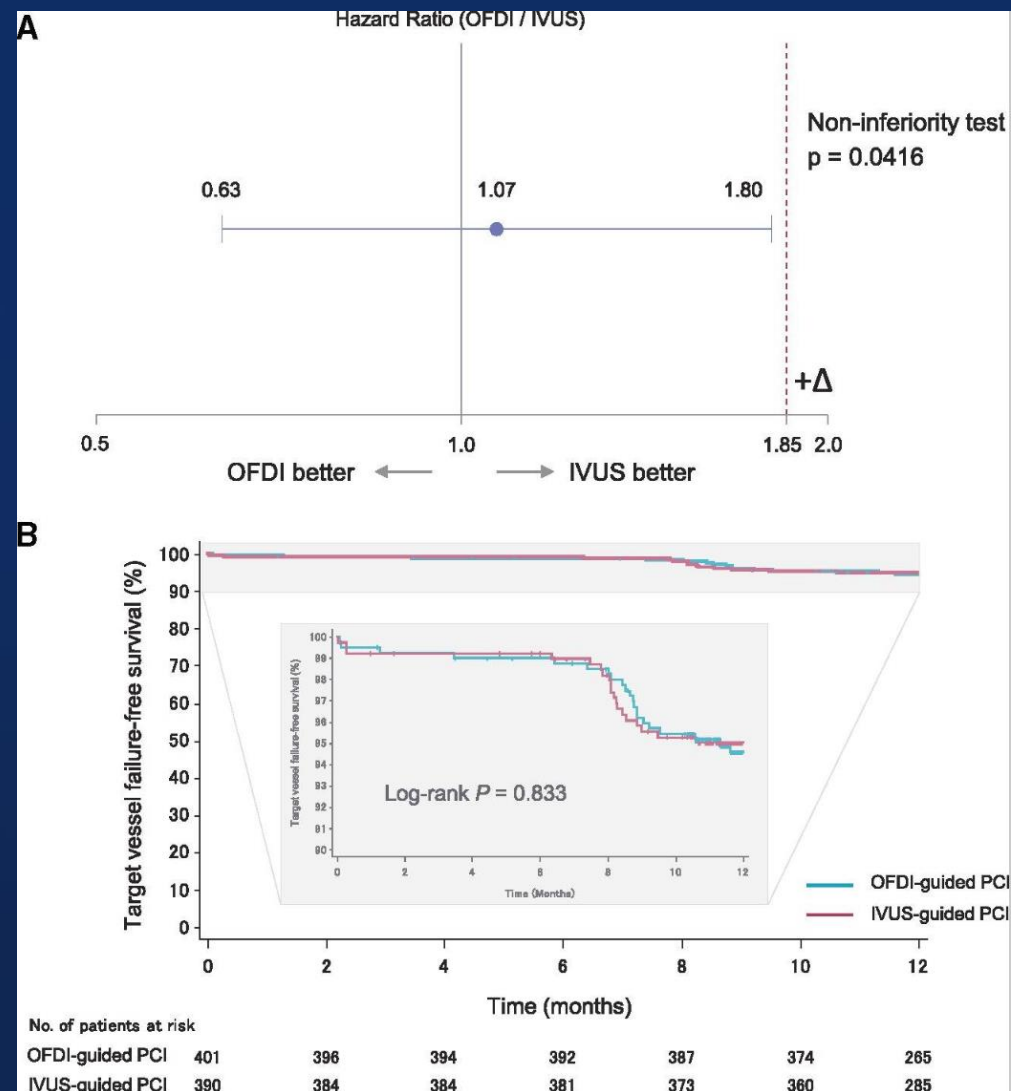

Kubo T et al. *Eur Heart J*. 2017 Nov 7; 38(42): 3139–3147.

IVUS vs OCT guided PCI

OPINION Trial

	OFDI-guided PCI (n = 412)	IVUS-guided PCI (n = 405)	P-value
Stent diameter (mm)	2.92 ± 0.39	2.99 ± 0.39	0.005
Total stent length (mm)	25.9 ± 13.2	24.8 ± 13.2	0.06
Multiple stenting	68 (16.5)	59 (14.6)	0.50
Pre-dilatation	316 (76.7)	316 (78.0)	0.67
Post-dilatation	316 (76.7)	304 (75.1)	0.62
Balloon dilatation of side-branch	39 (9.5%)	41 (10.1%)	0.81
Maximum balloon diameter (mm)	3.1 ± 0.8	3.3 ± 1.2	0.06
Maximum inflation pressure, atmosphere	16.0 ± 4.2	16.0 ± 4.2	0.70
No. of OFDI/IVUS procedure	3.0 ± 1.1	3.0 ± 1.1	0.14
Total amount of contrast	164 ± 66	138 ± 56	<0.001

Intravascular Ultrasound Versus Optical Coherence Tomography Guidance

Ron Waksman, MD, Hironori Kitabata, MD, Francesco Prati, MD, Mario Albertucci, MD,
Gary S. Mintz, MD

IVUS remains the more trusted modality for stent sizing
and optimization until OCT own criteria are validated
with clinical outcomes

High frequency OCT for pre-intervention coronary imaging : First in- Human Results

- To investigate the ability of HF-OCT to image pre intervention coronary arteries. (Prior to any vessel preparation)
- **Clear Image Length (CIL)**; cross-sectional images were identified as ‘clear image’ when > 270 degrees of the lumen and vessel contour were free of blood or any artifact.
- To understand the impact of lesion severity on image quality; MLA was calculated, and quartiles were compared.

2022 TCT



1st Generation: TD-OCT (2001)

- 250 A-Lines/frame
- Balloon Occlusion of the vessel
- Pullback speed 1-3mm/sec

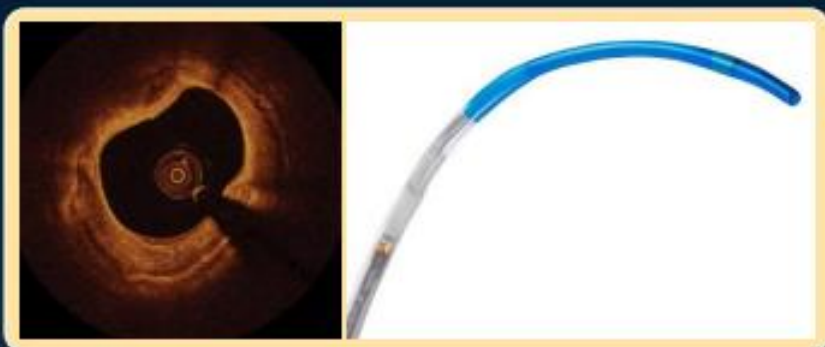

2nd Generation: FD-OCT (2007)

- 2.7F RX catheter
- Swept Laser (90 K), 500 lines /frame
- FOV ~ 5mm
- Up to 36mm/sec (2.5 second – 75mm)

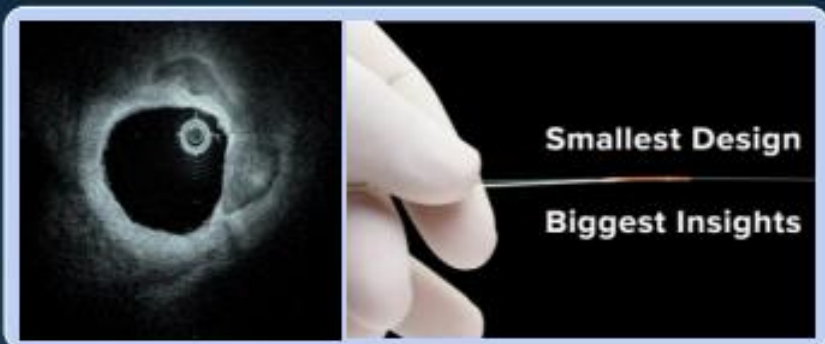

3rd Generation: HF-OCT (02/22/2021)

- 1.8F RX catheter
- VCSEL laser (200 K), 800 lines / frame
- FOV > 7mm
- Up to 100 mm/sec (1 second pullback – 100mm)



Results - Impact of Lesion Severity on Image Quality - MLA

We demonstrate the ability to image severe lesions with excellent clarity.

- a. *25% of lesions in the study were below MLA 1.0 (which is the nominal size of most catheters)*
- b. *ANOVA testing for difference in CIL across different lesion severity by MLA.*
 - i. *We separate MLA severity into quartiles*
 - ii. *Levene statistic confirms homogeneity among the groups*
 - iii. *ANOVA test demonstrates no statistical difference among the 4 quartiles for CIL*
 - iv. *Tukey HSD post hoc analysis demonstrates no statistical difference in CIL between pullbacks of lesions with MLA <1.0 compared to all other groups.*

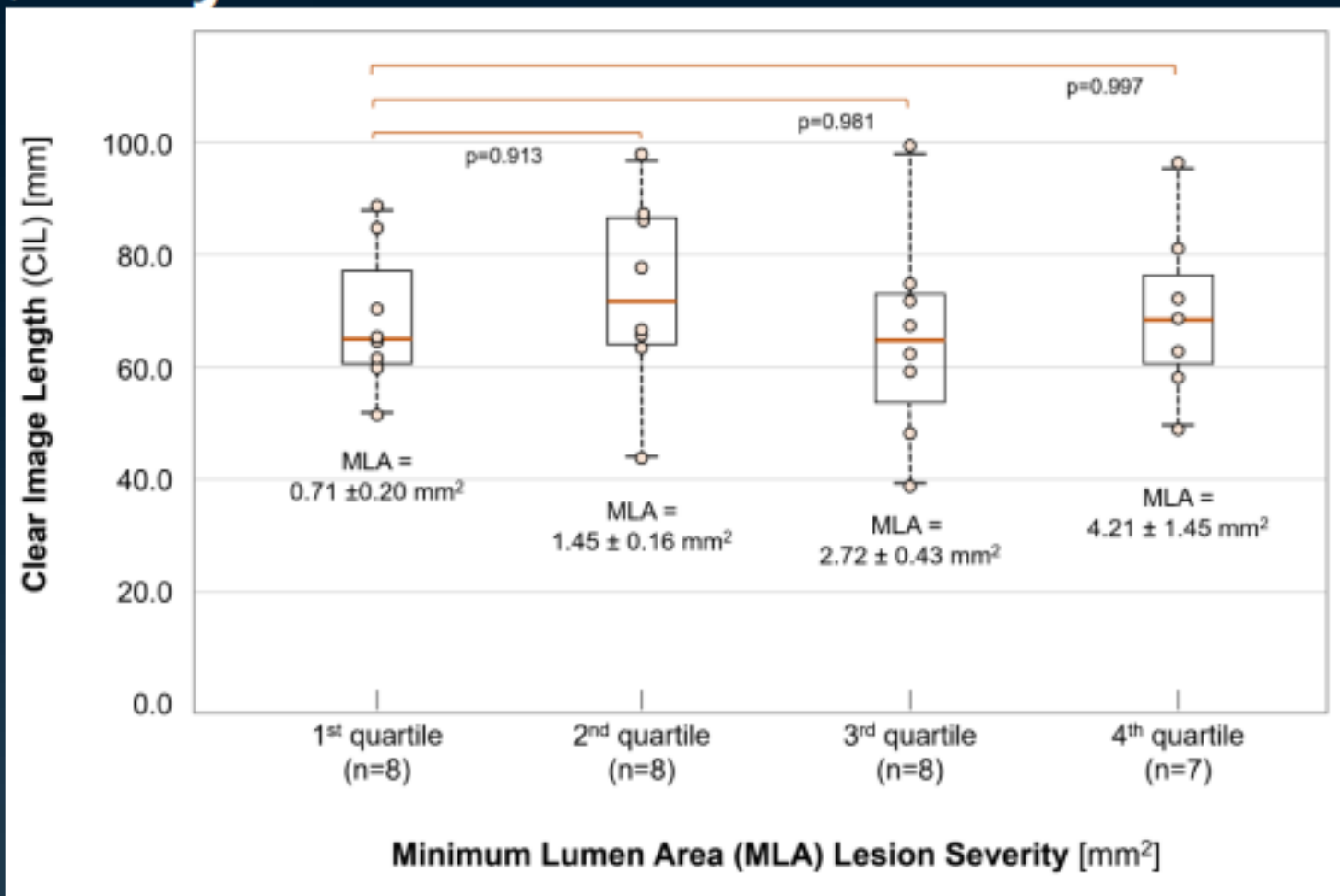

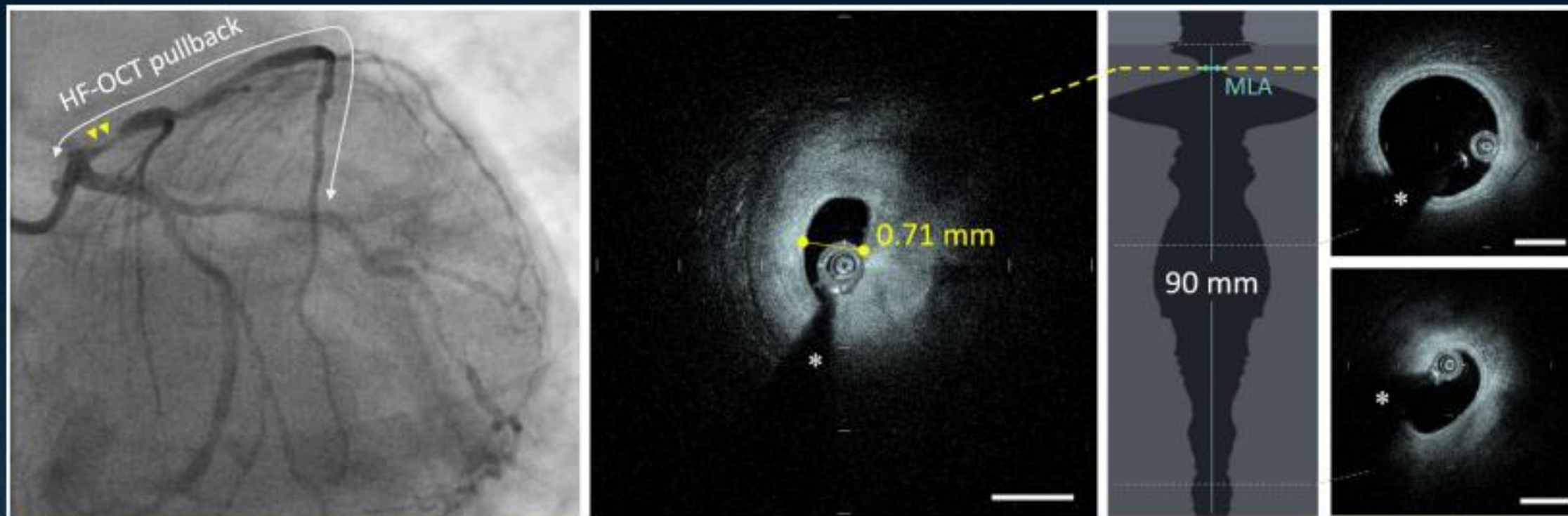

Results, clinical HF-OCT Imaging

- Pullback length outside the guide catheter = 90 mm
- Clear image length (CIL) = 88 mm (or 98% of the pullback length)

Conclusion

- Results from this study show the **efficacy of HF-OCT for the imaging of pre-intervention** coronary lesions without any predilatation or vessel instrumentation.
- This may be an ideal platform to explore **pre-intervention planning** including **deriving vessel physiology** from fluid dynamic analysis.

OCT for calcified lesion

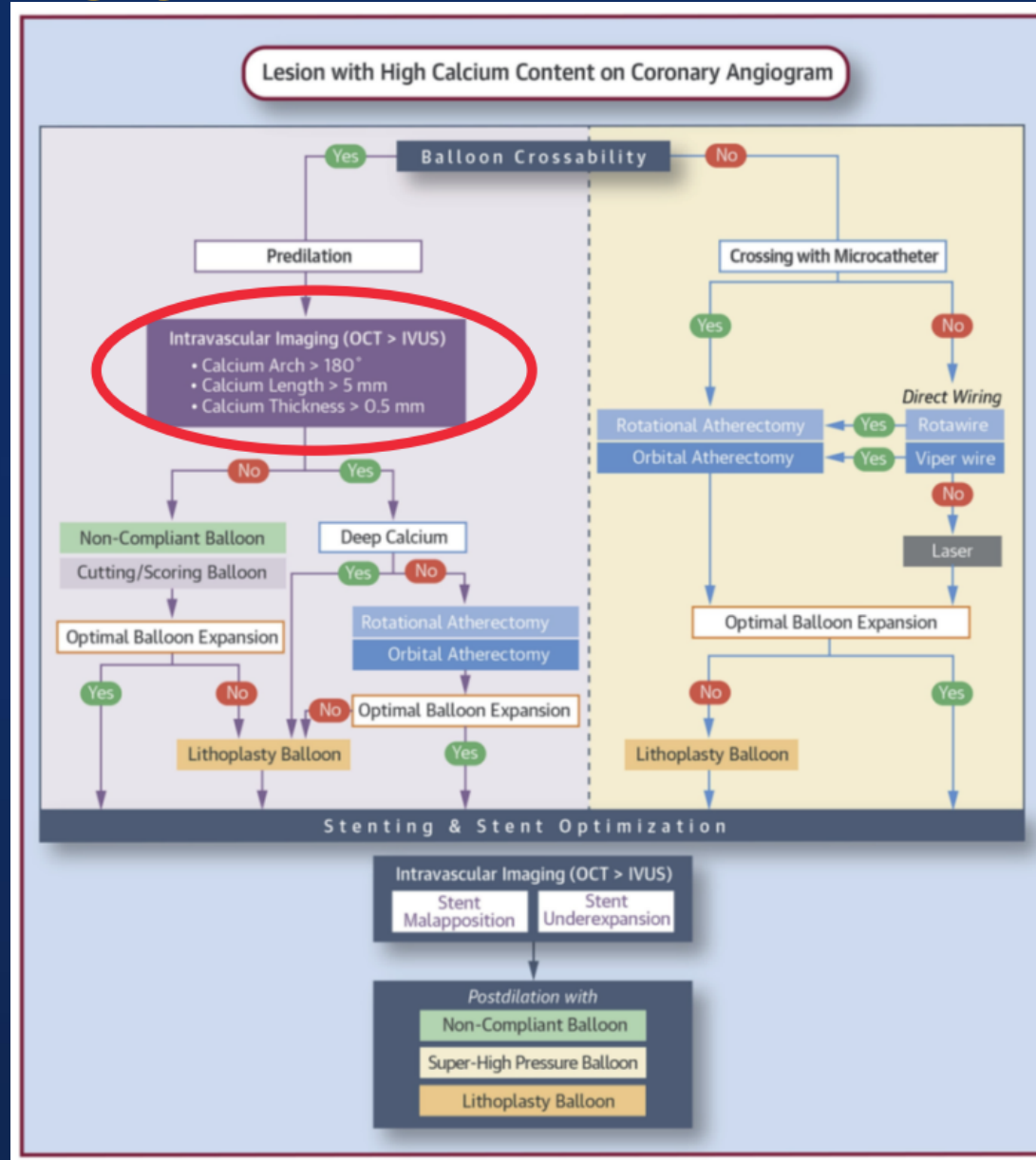

OCT in Calcified Lesions Visualization of Calcium with Thickness

OCT in Calcified Lesions Visualization of Calcium with Thickness

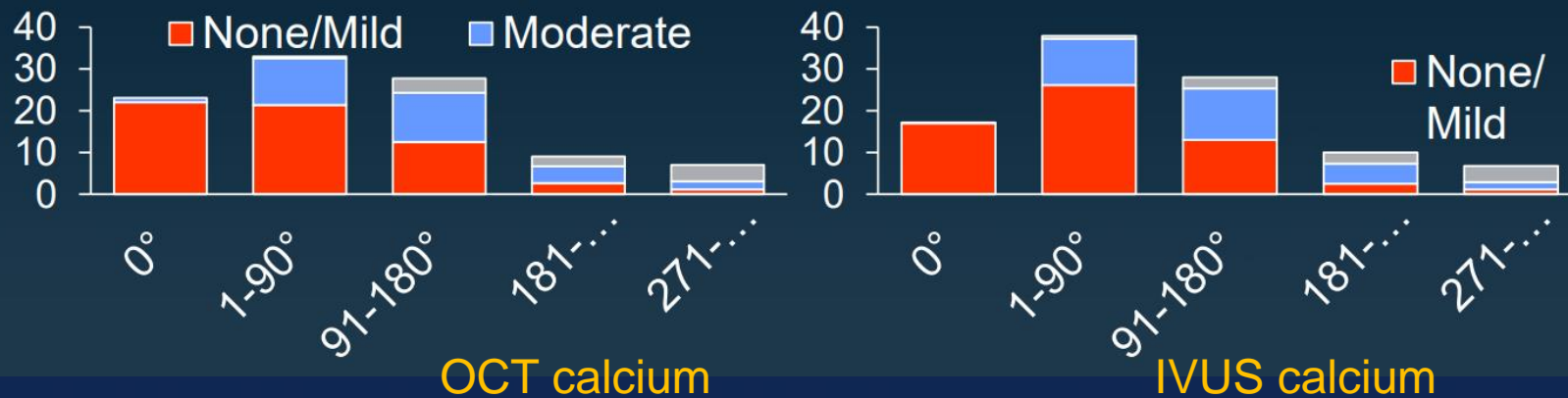
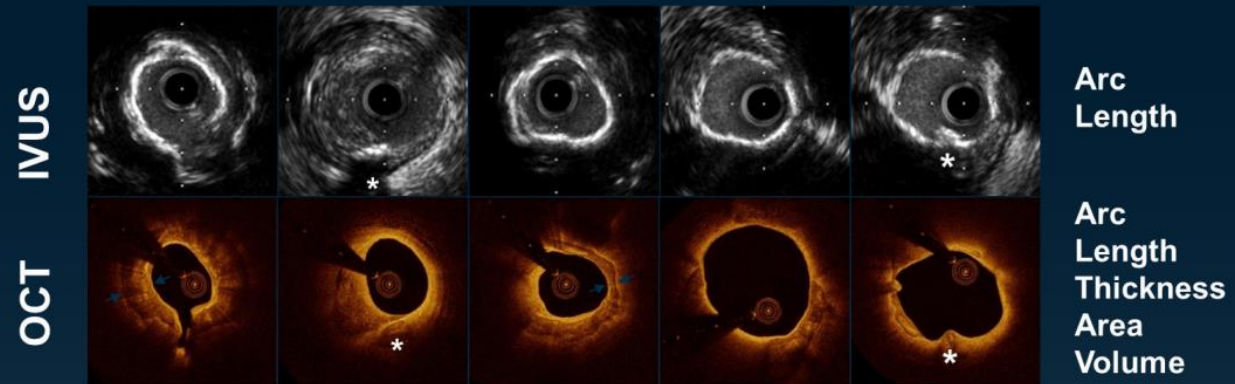

Wang et al. JACC Cardiovasc Imaging 2017;10:869-79
Mintz and Guagliumi. Lancet 2017;390:793-809

NIRS

Near-infrared Spectroscopy

Near-infrared Spectroscopy

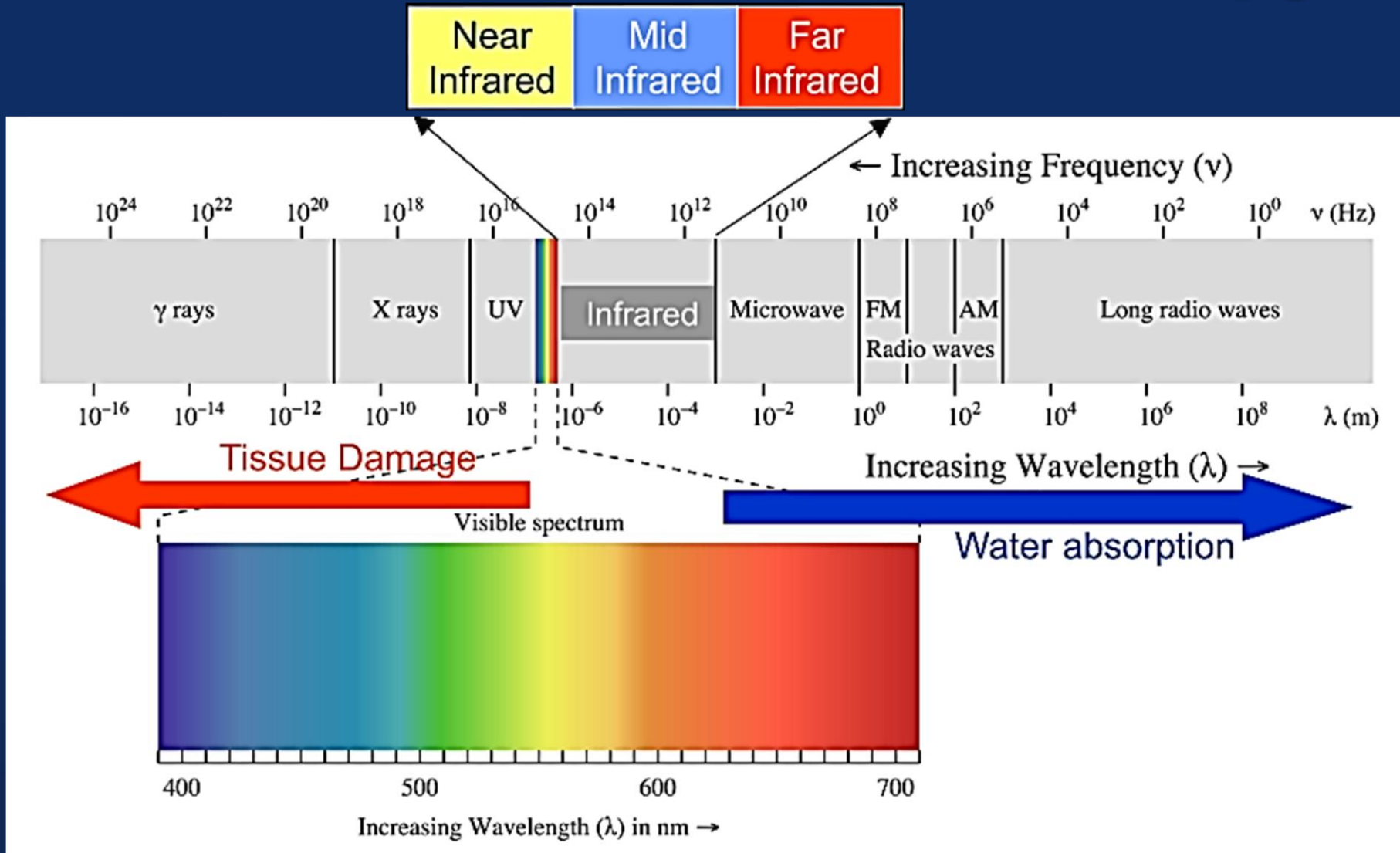

Process of NIR Spectroscopy

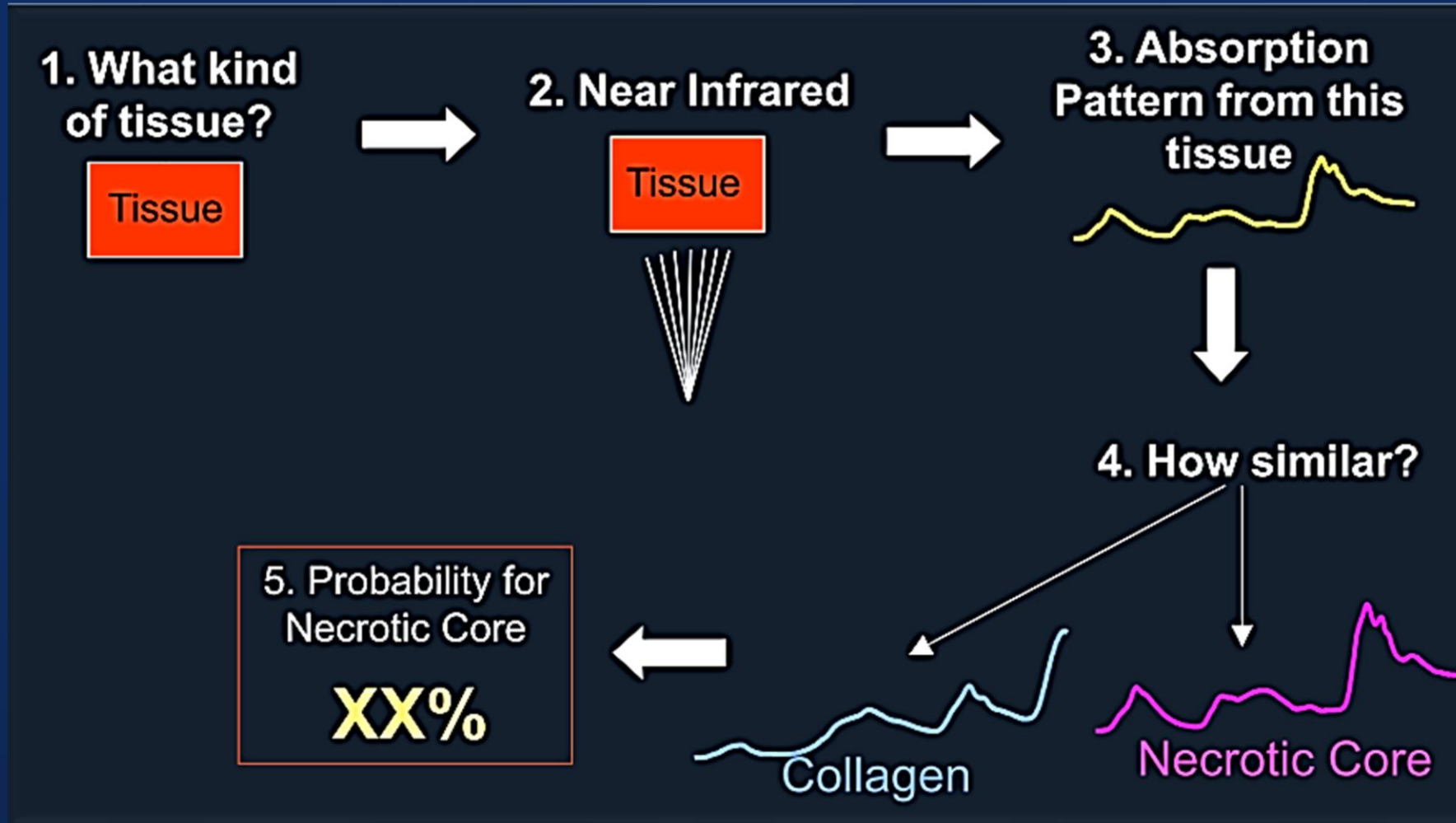

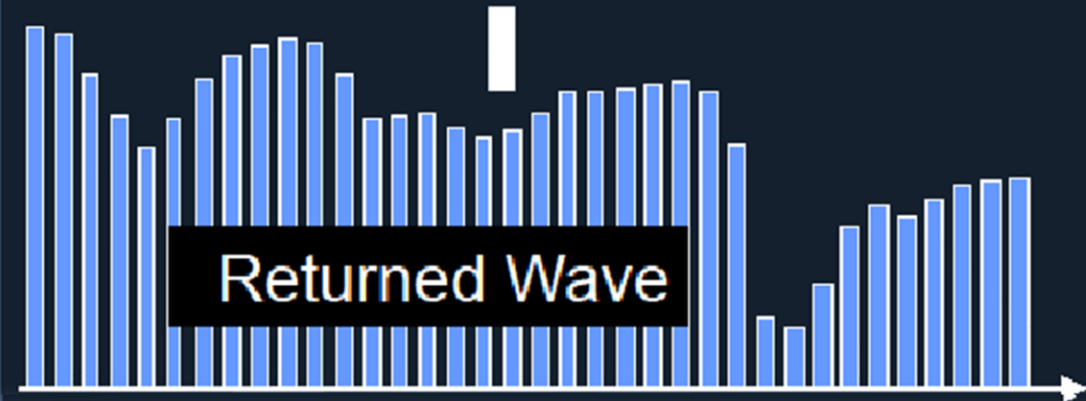
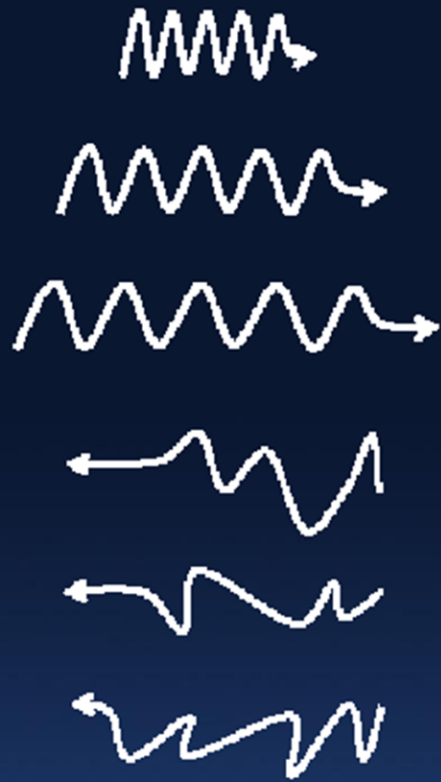

Step 1

Step 2

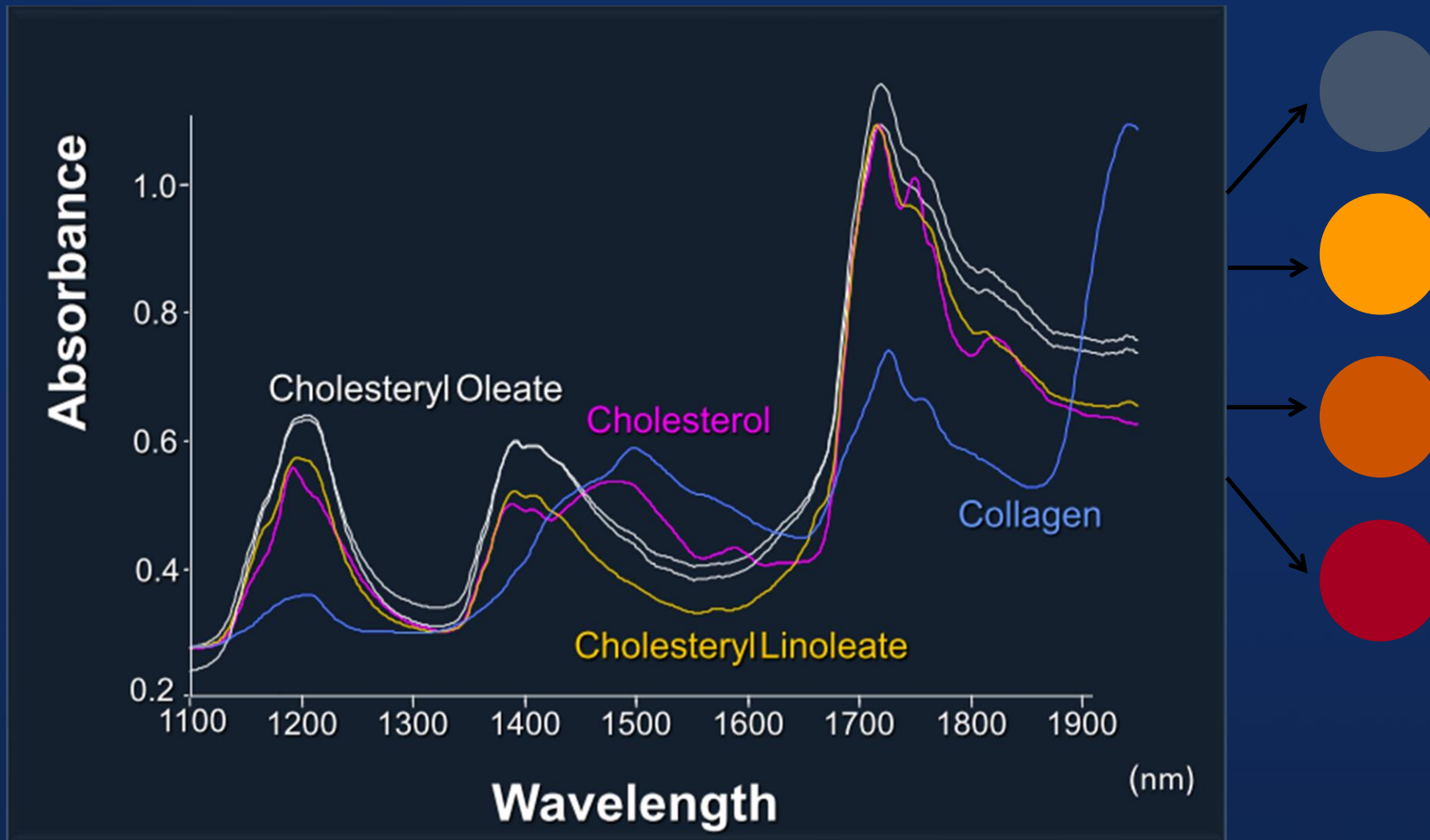

Step 3

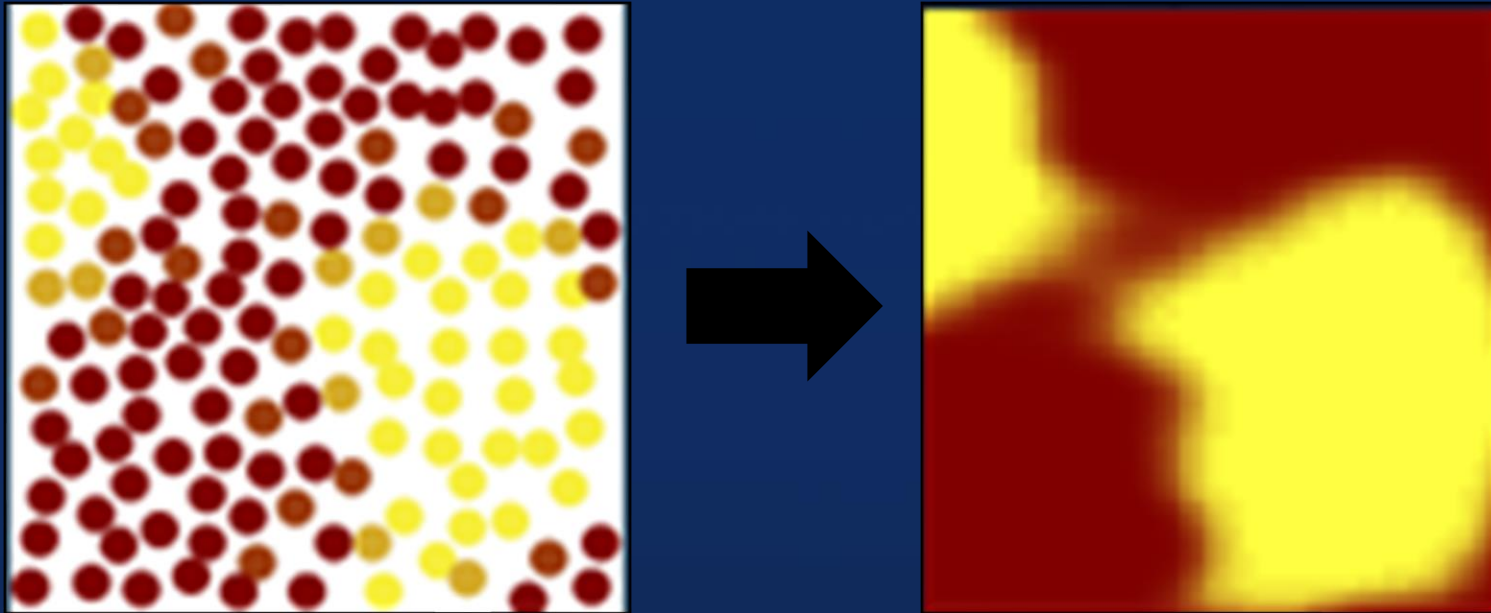

Lipid Core Burden Index (LCBI)
= Yellow pixel / All variable pixel x 1000

Near Infrared Spectroscopy

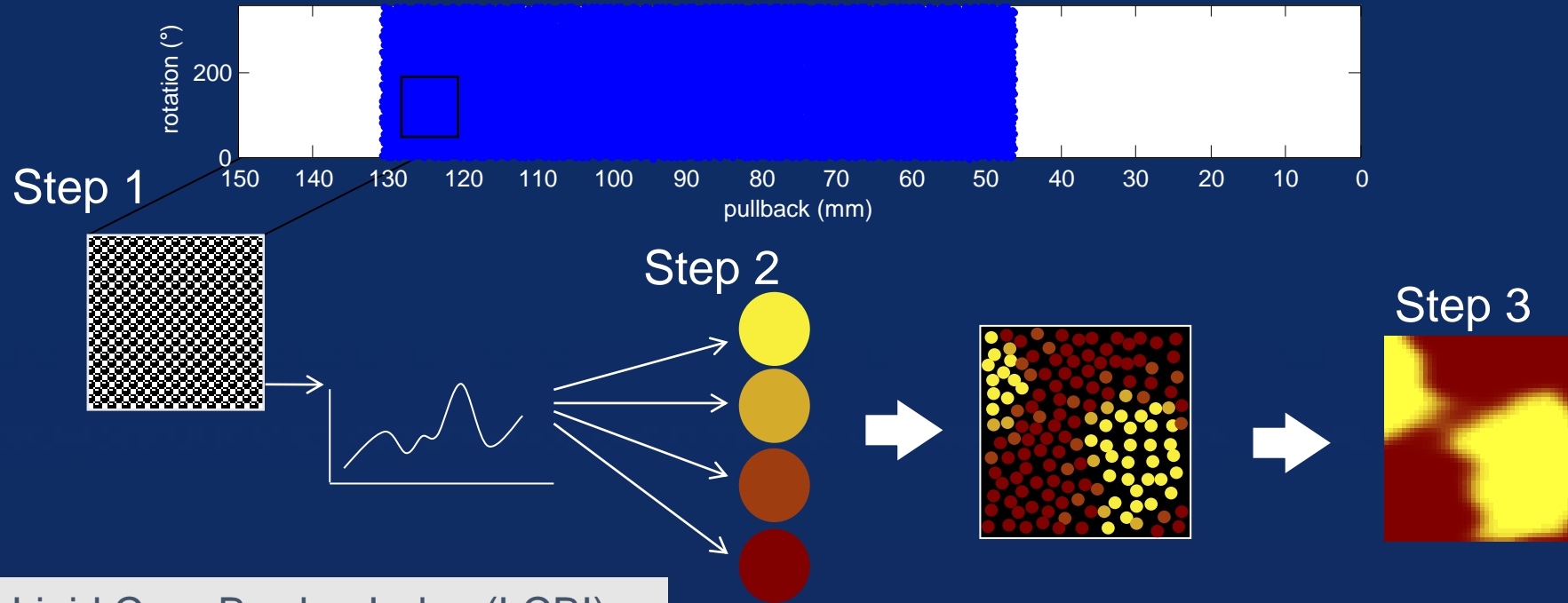

Lipid Core Burden Index (LCBI)
= Yellow pixel / All variable pixel
× 1000

Lesion
LCBI Max_{4mm}

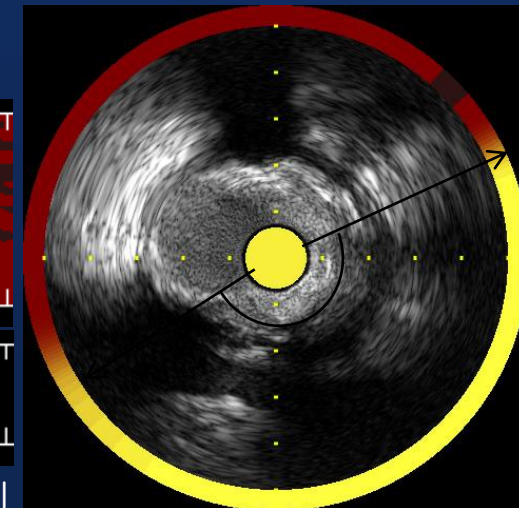
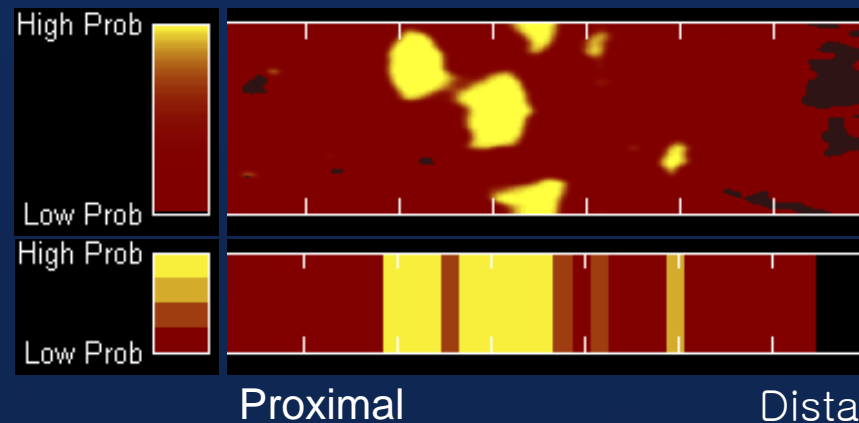

Formation of the Cap Thickness Prediction Image

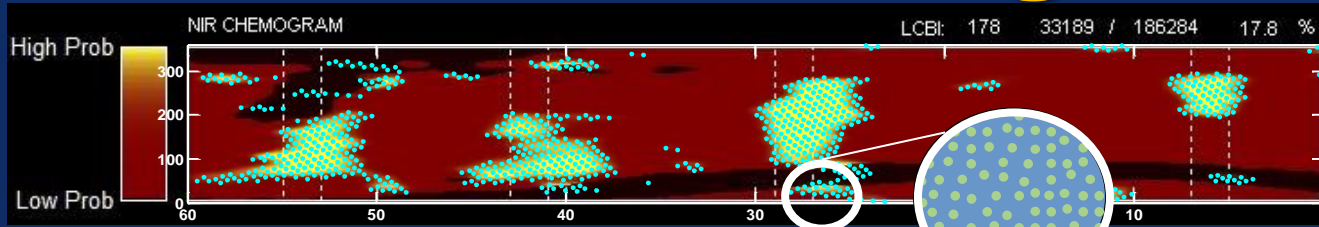

Spectra acquired at discrete pullback and rotation positions

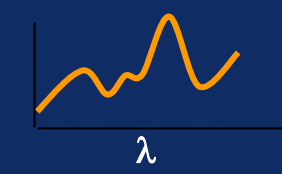

LCP Spectra transformed into posterior probability of thin cap presence



Probability mapped to a color

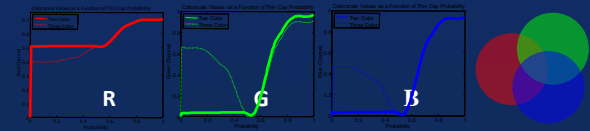

Pixels formed into an image

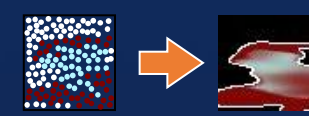

Quantification with Lipid Core Burden Index

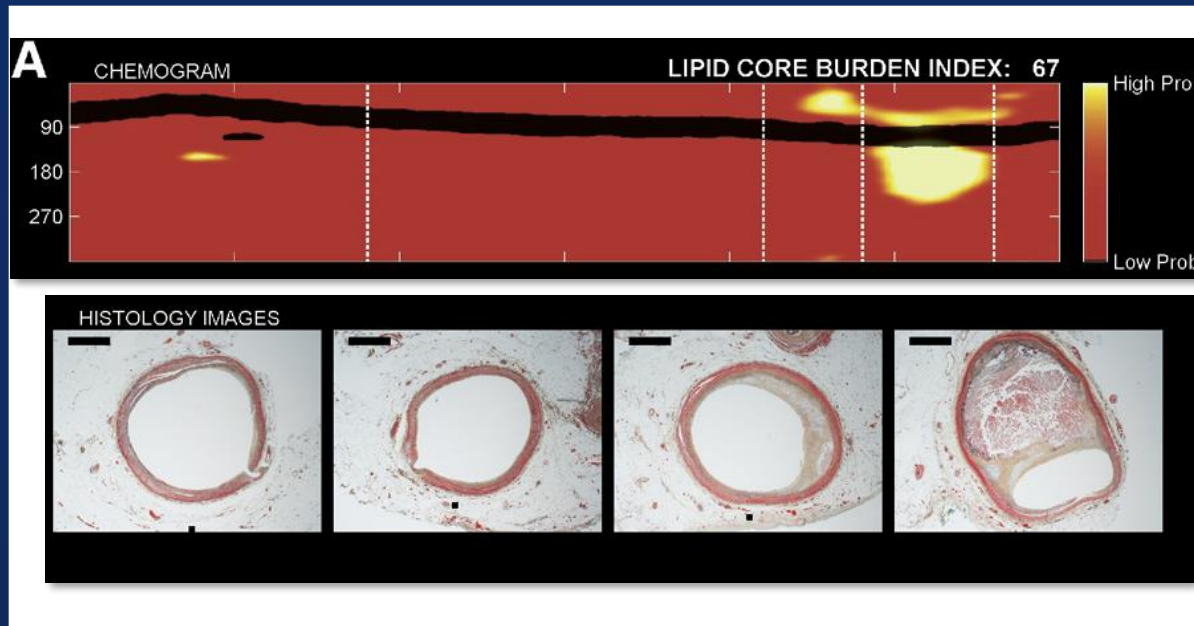

LCBI = Lipid Core Burden Index
(% yellow pixels of ROI x 10)

maxLCBI = the 4 mm segment
with highest lipid content

Chemogram Color	Indication
Red	Low probability of LCP
Yellow	High probability of LCP
Black overlay	Indeterminate

Possible causes:

- Guide wire
- Thrombus
- Flow disturbance

Combination NIRS-IVUS Instrument

TVC Imaging System™

- Laser
- Dual monitors, touchscreen interface
- Pull-back and rotation device

TVC Insight™ Catheter

- Single use, 3.2 Fr
- Dual modality
 - Spectroscopy detects lipid core plaque
 - IVUS detects vessel structure



Lipid Core Plaque Imaging

VH-IVUS vs. OCT vs. NIRS-IVUS

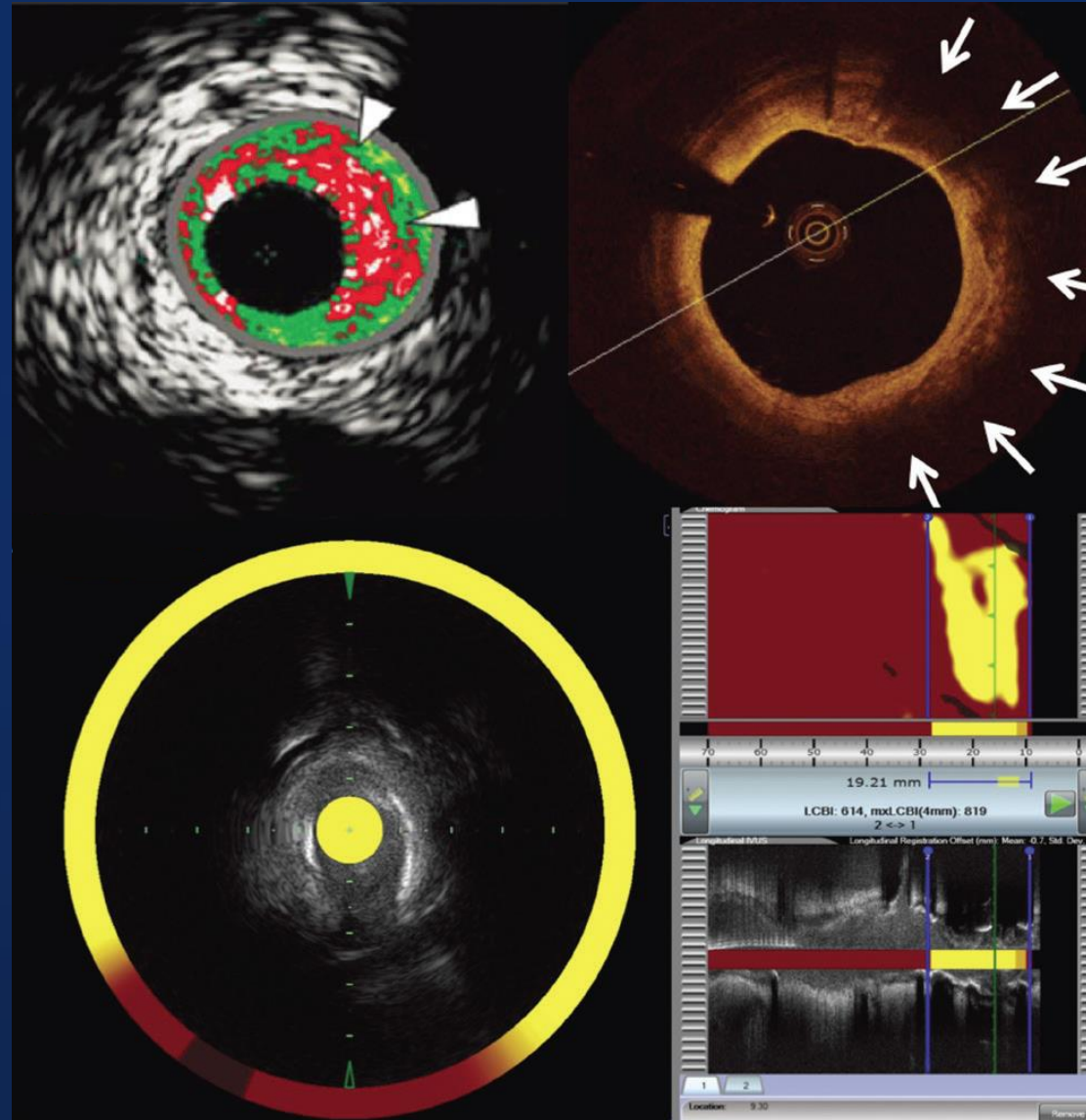

Different type of Calcified Plaque

Necrotic core
Behind Calcium

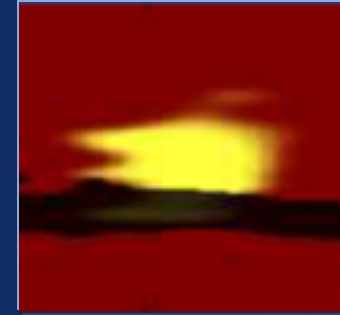
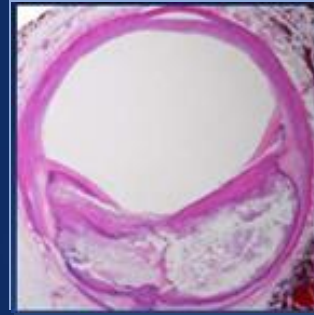
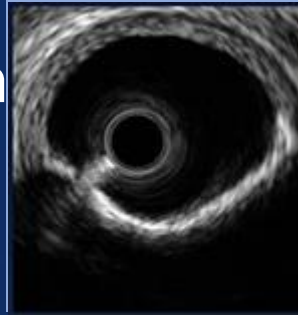

Calcium only

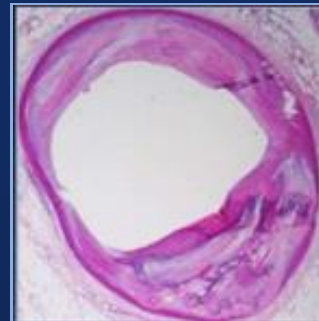
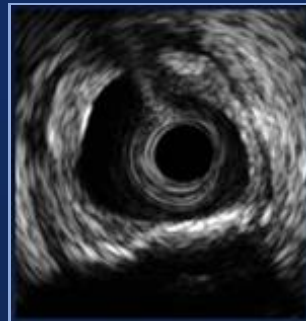

SPECTACL Study

In vivo Validation of NIRS for Detection of Lipid Core Coronary Plaques

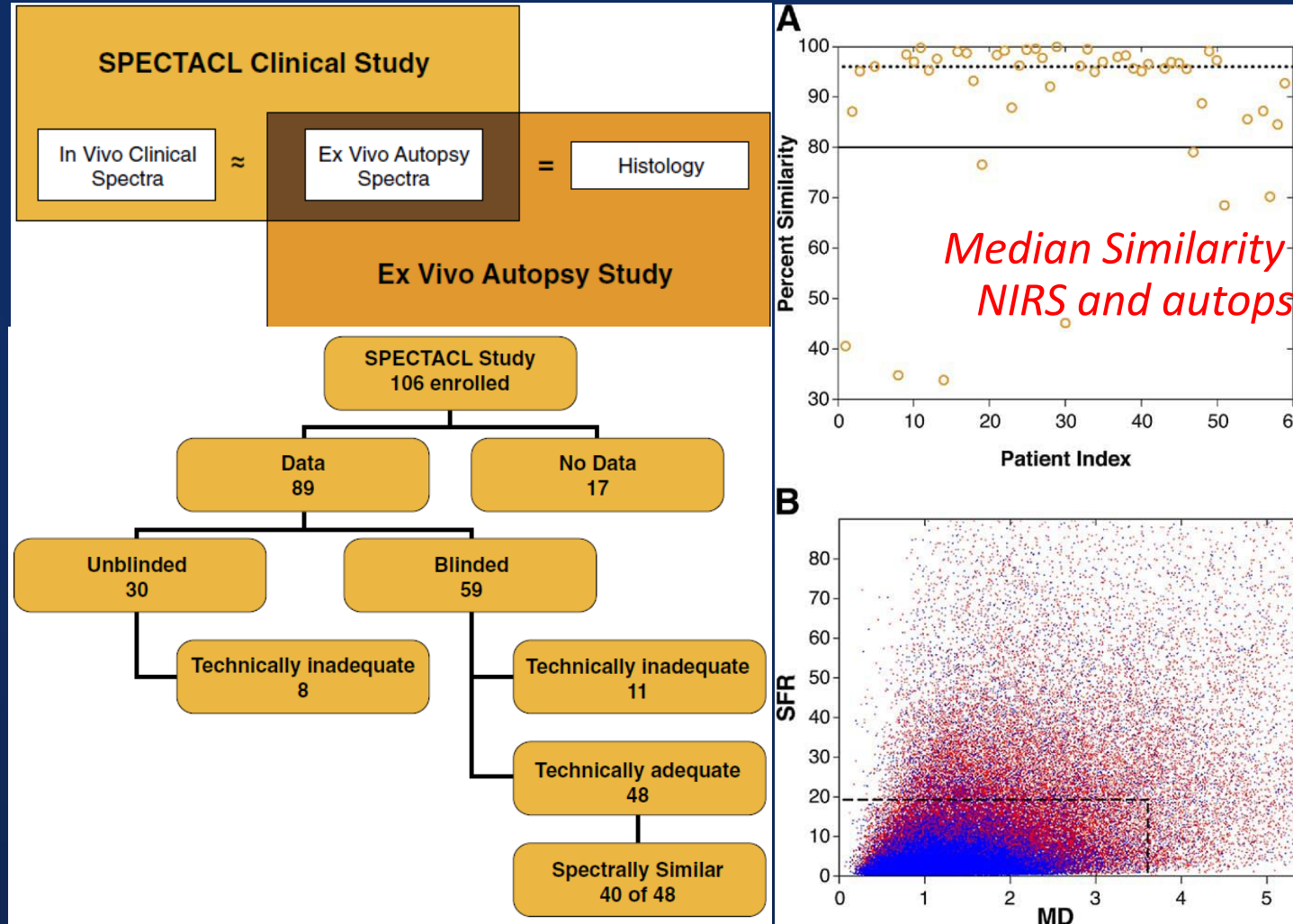

Sergio et al. *J Am Coll Cardiol Img*, 2009

The Applications of NIRS-IVUS

- Identifying lesions possessing both architectural features and compositional data characteristic of vulnerable plaques
- Identifying large volume lipid-core plaque (LCP), which may be at greater risk for distal embolization during PCI
- Using IVUS to determine the length of vessel having significant plaque burden and delineating by NIRS the extent of the plaque burden occupied by LCP, data which may influence stent length selection
- Localizing nonculprit lesions with morphologic and compositional characteristics of “vulnerable plaque”
- Analyzing plaque composition in heavily calcified segments, a setting in which other imaging modalities have limited utility

The Applications of NIRS-IVUS

Detection of Potentially Vulnerable Nonflow-Limiting Plaque

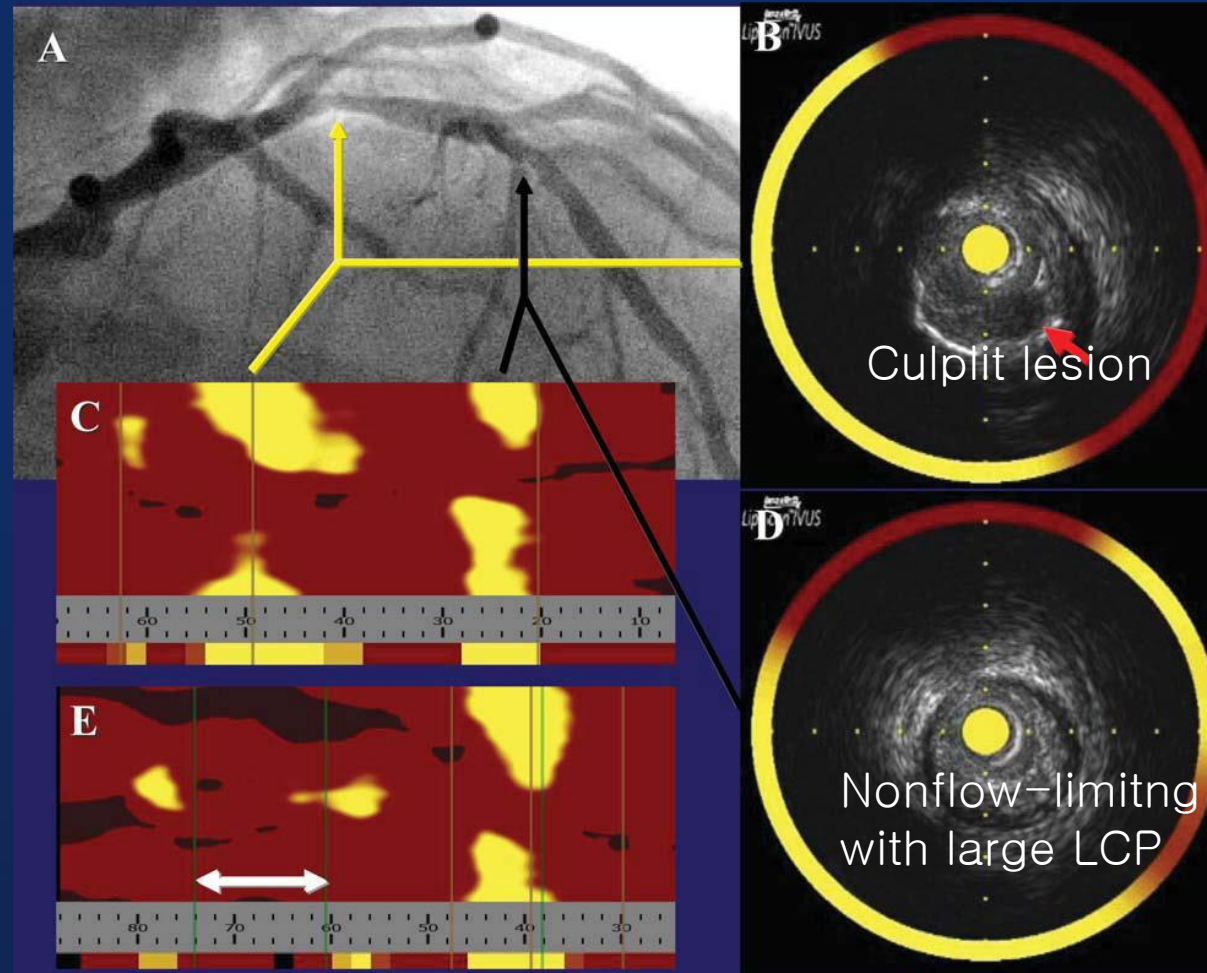

RD Madder et al. *Catheterization and Cardiovascular Interventions*, 2013

The Applications of NIRS-IVUS

Detection of LCP despite Extensive Calcification

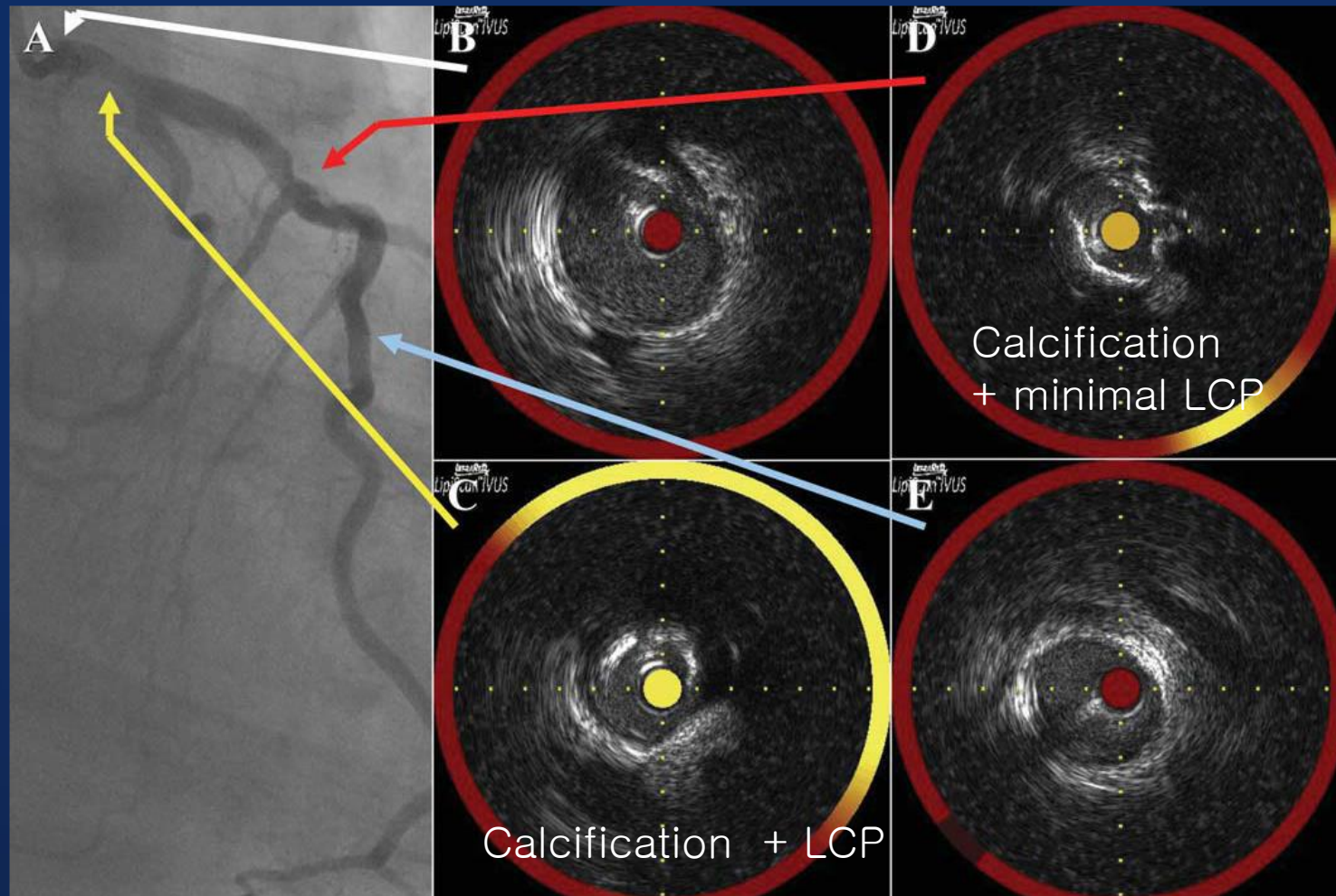

RD Madder et al. *Catheterization and Cardiovascular Interventions*, 2013

The Applications of NIRS-IVUS

Characterization of a Lesion Causing Chronic Total Occlusion

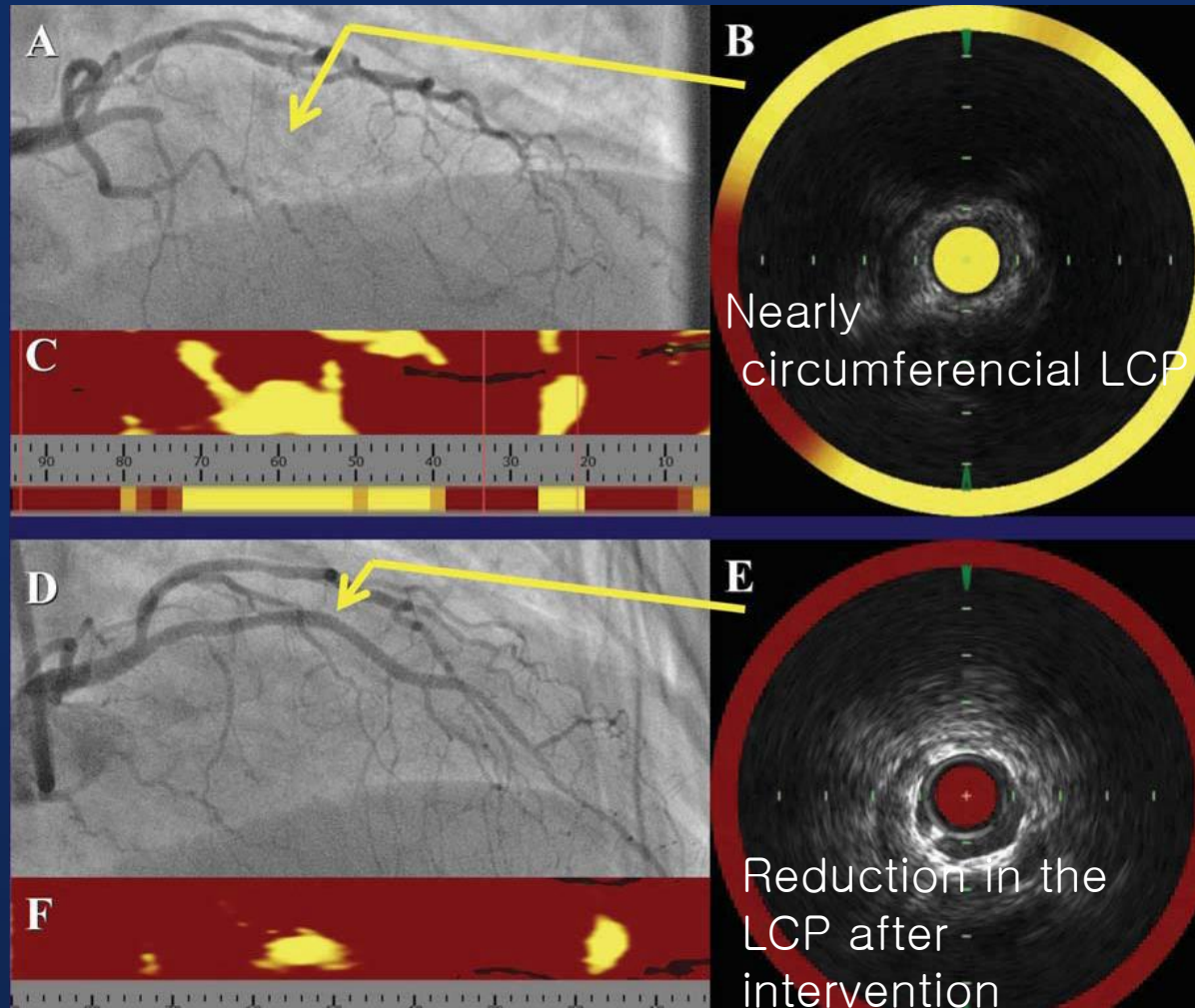

RD Madder et al. *Catheterization and Cardiovascular Interventions*, 2013

Characterization of Atherosclerosis

correlation among IVUS, NIRS and VH-NC

IVUS and NIRS

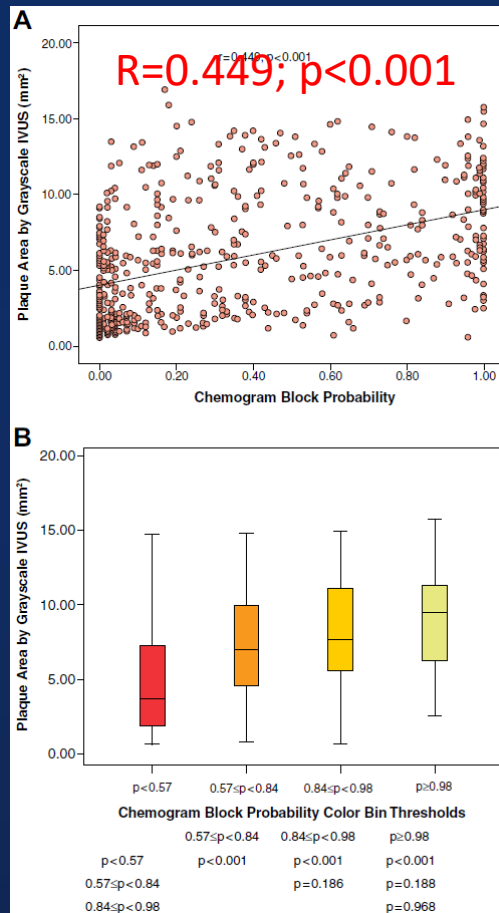

IVUS and VH-NC

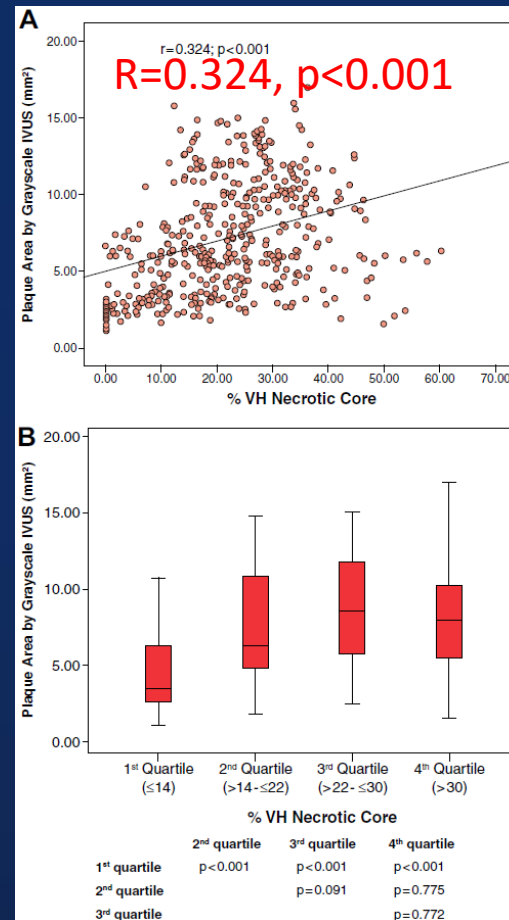

NIRS and VH-NC

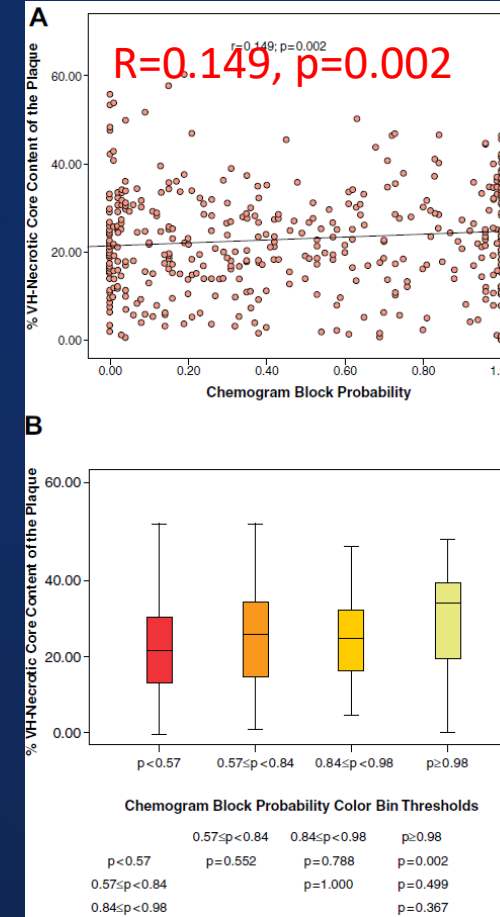

*31 patients with a common region of interest between 2 side branches

*IVUS : grayscale plaque area *NIRS : chemogram block *VH-NC : necrotic core percentage

Brugaletta et al. JACC: Cardiovascular Imaging, 2011

Reproducibility of NIRS

Automated pullback catheter
performed in duplicate
in 36 vessels in 31 patients

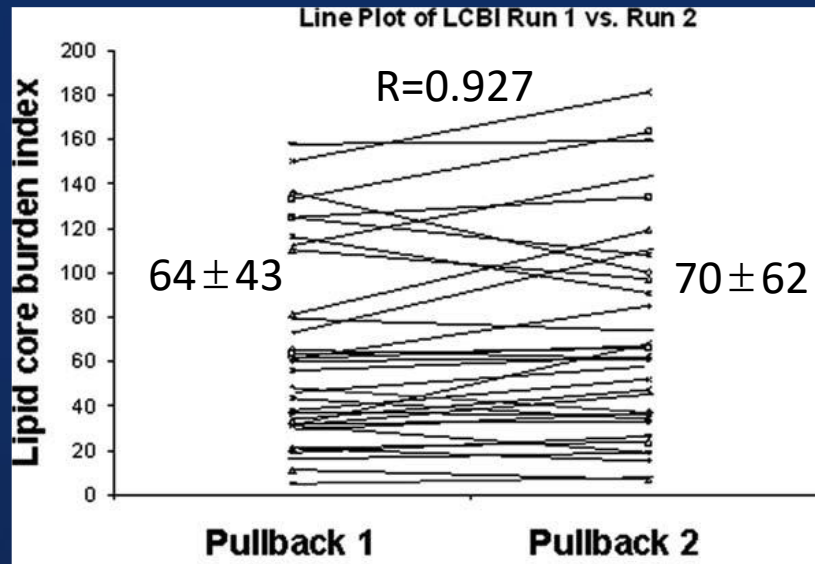

Excellent correlation

The changes in LCBI
after stenting
in 25 vessels in 22 patients

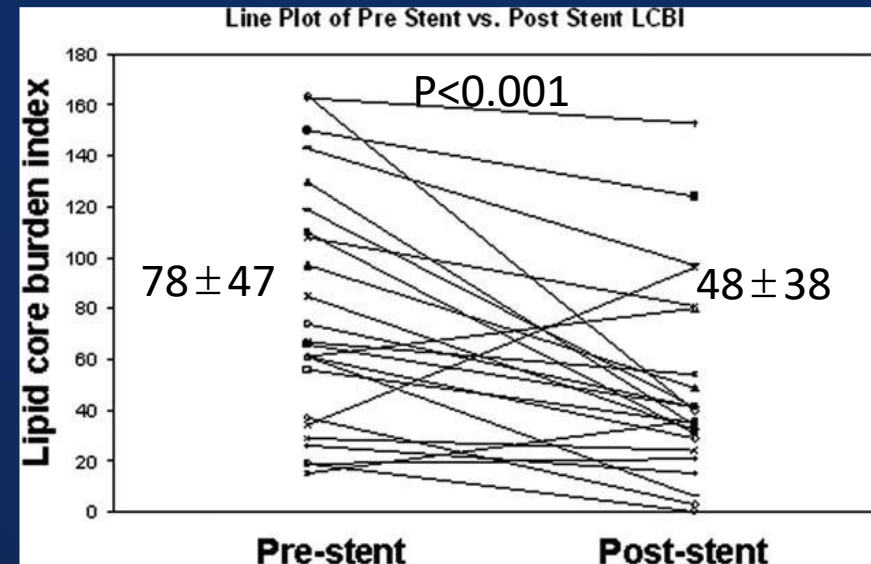

The mean LCBI decreased by 40%

BA Garcia et al. Catheterization and Cardiovascular Interventions, 2010

Five Different STEMI

NIRS-IVUS Reveals Five Different Causes

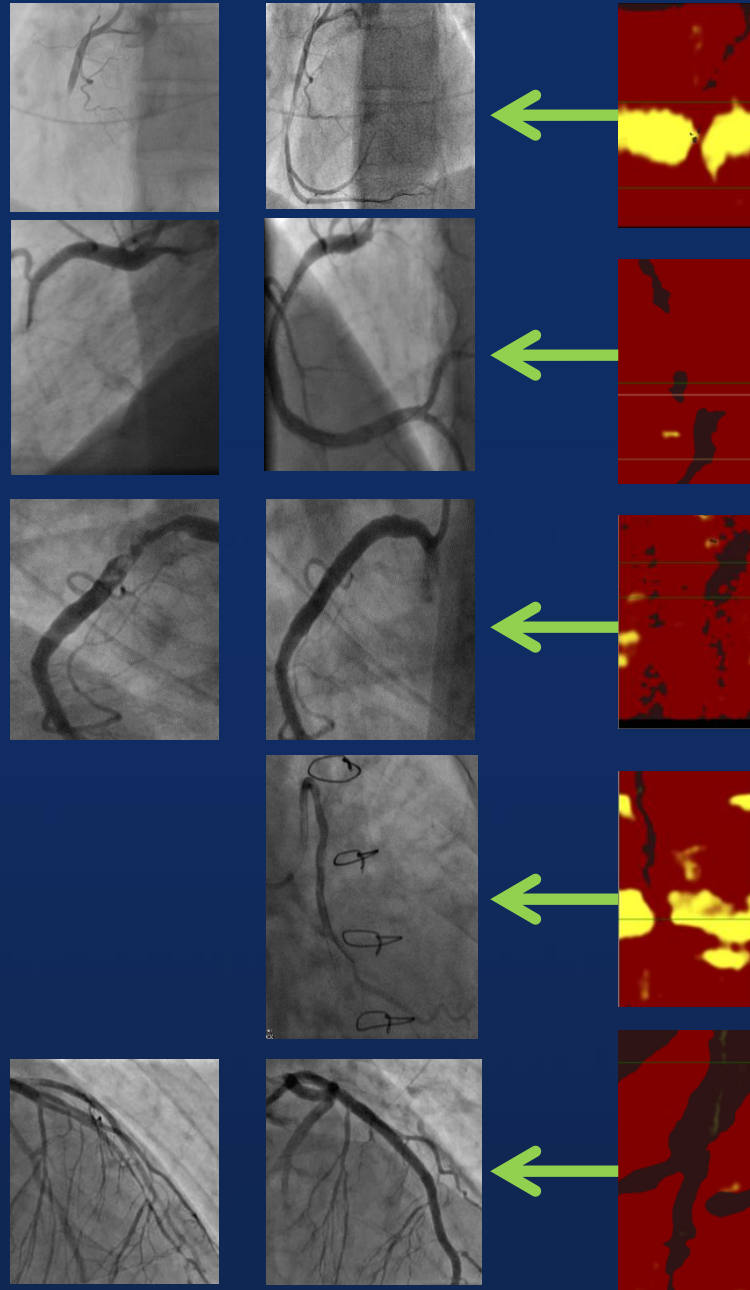

Lipid Core Plaque

Courtesy Dr. Ryan Madder

Stent Thrombosis

Courtesy Dr. David Erlinge

Calcified Nodule

Courtesy Dr. Ryan Madder

Lipid Core In SVG

Courtesy Dr. David Erlinge

Dissection

Courtesy Dr. David Erlinge

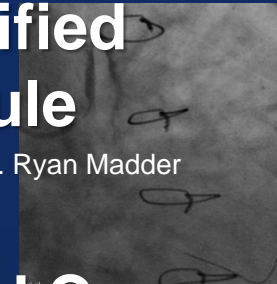

NIRS Findings in STEMI Patients



Culprit vs. non-culprit in STEMI

The characteristic of NIRS

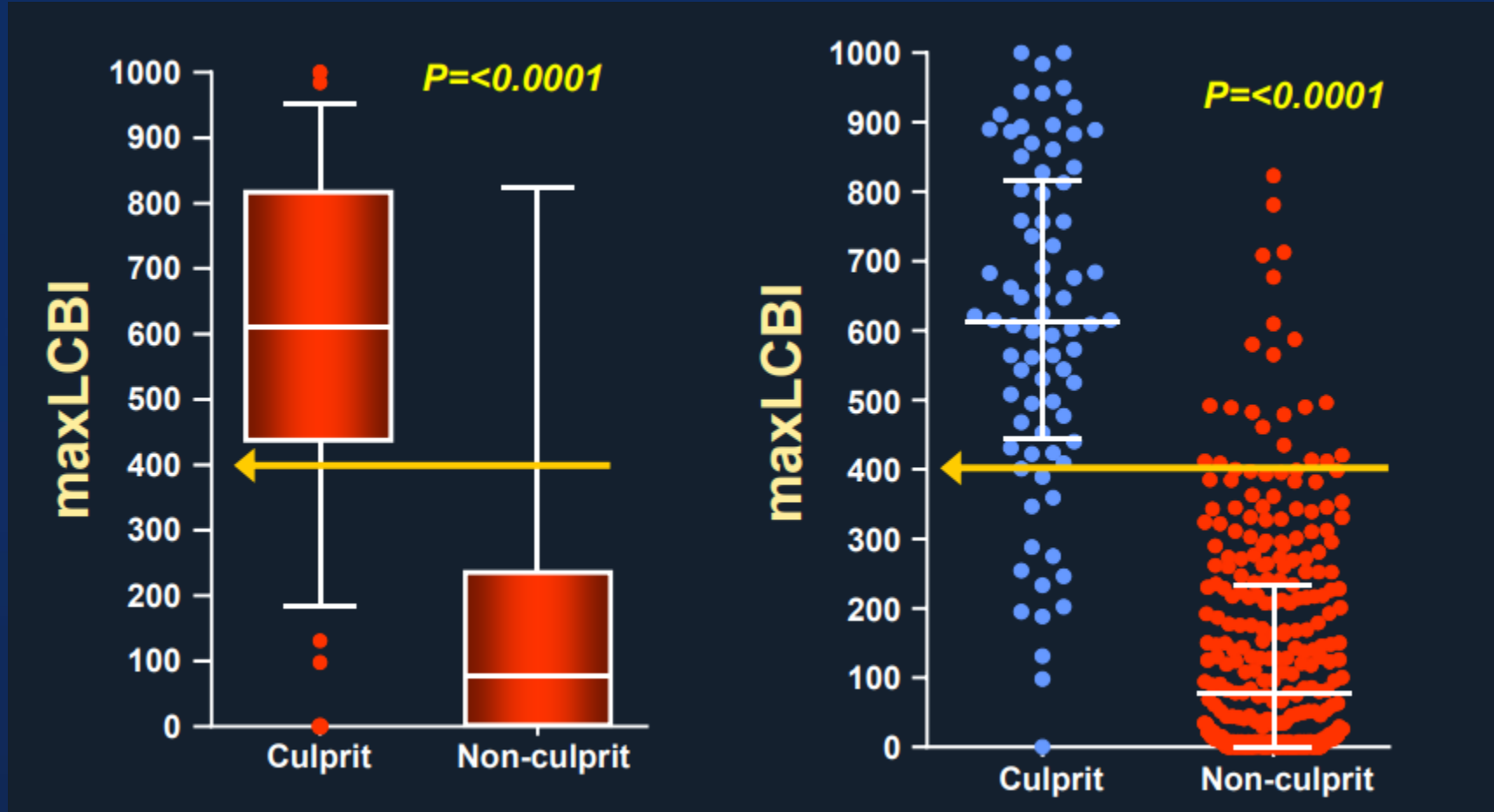

Lipidic Plaque detected by NIRS and Periprocedural MI

Parameter*	Threshold†	Relative risk of peri-procedural MI (95% CI)	p‡
maxLCBI _{4mm}	≥500	12 (3.3 to 48)	0.0002
LDL – mg/dL	>100	5.4 (1.4 to 23)	0.03§
Complex Plaque	Y	3.5 (0.91 to 14)	0.15
Degree Stenosis – %	>75	3.1 (0.92 to 11)	0.14**

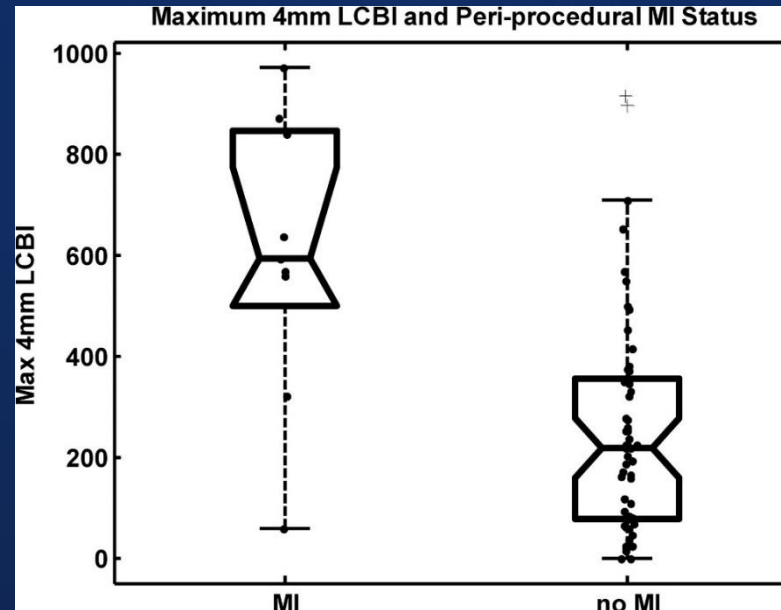
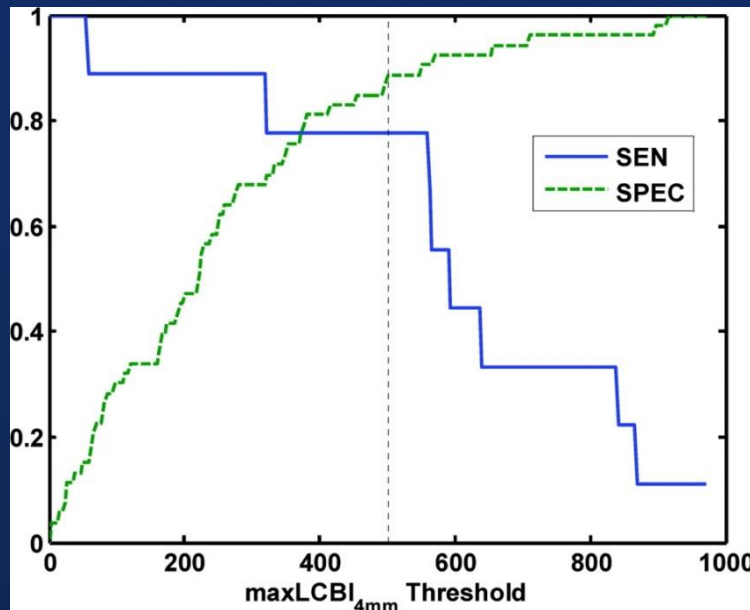

LCBI > 500 associated with 50% risk of periprocedural MI (95% CI, 28–62)

Goldstein, JA, et al. *Circulation: Cardiovascular Interventions*. 2011; 4: 429-437

Relationship between Lipidic Plaque detected by NIRS and Outcomes

- Prospective Single Center Study, 206 patients (ACS 47%)
- Primary Endpoint: Composite of all-cause mortality, non-fatal ACS, stroke and unplanned PCI during one-year FU
- >40mm non culprit segment of NIRS

Lipid Core Burden Index (LCBI)=188

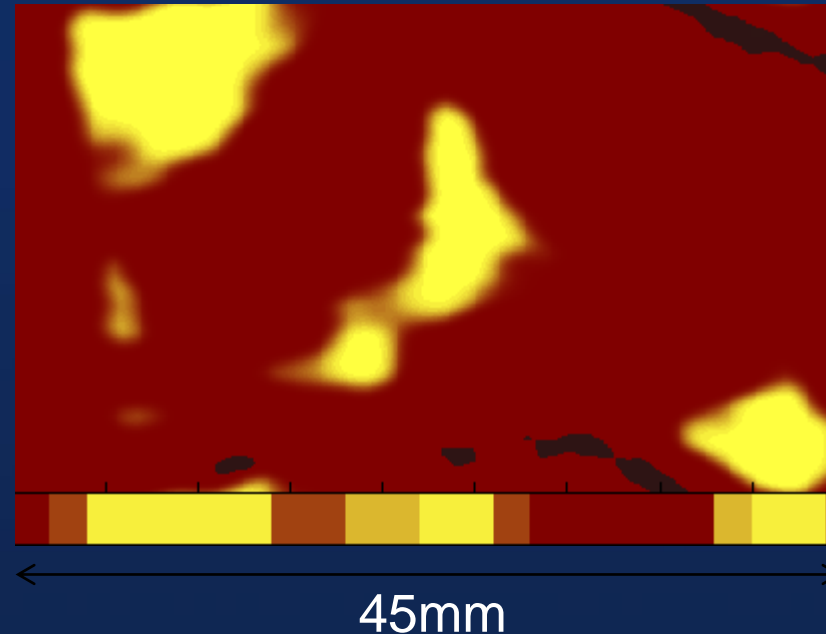

Relationship between Lipidic Plaque detected by NIRS and Outcomes

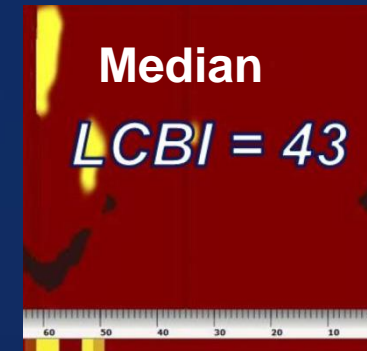
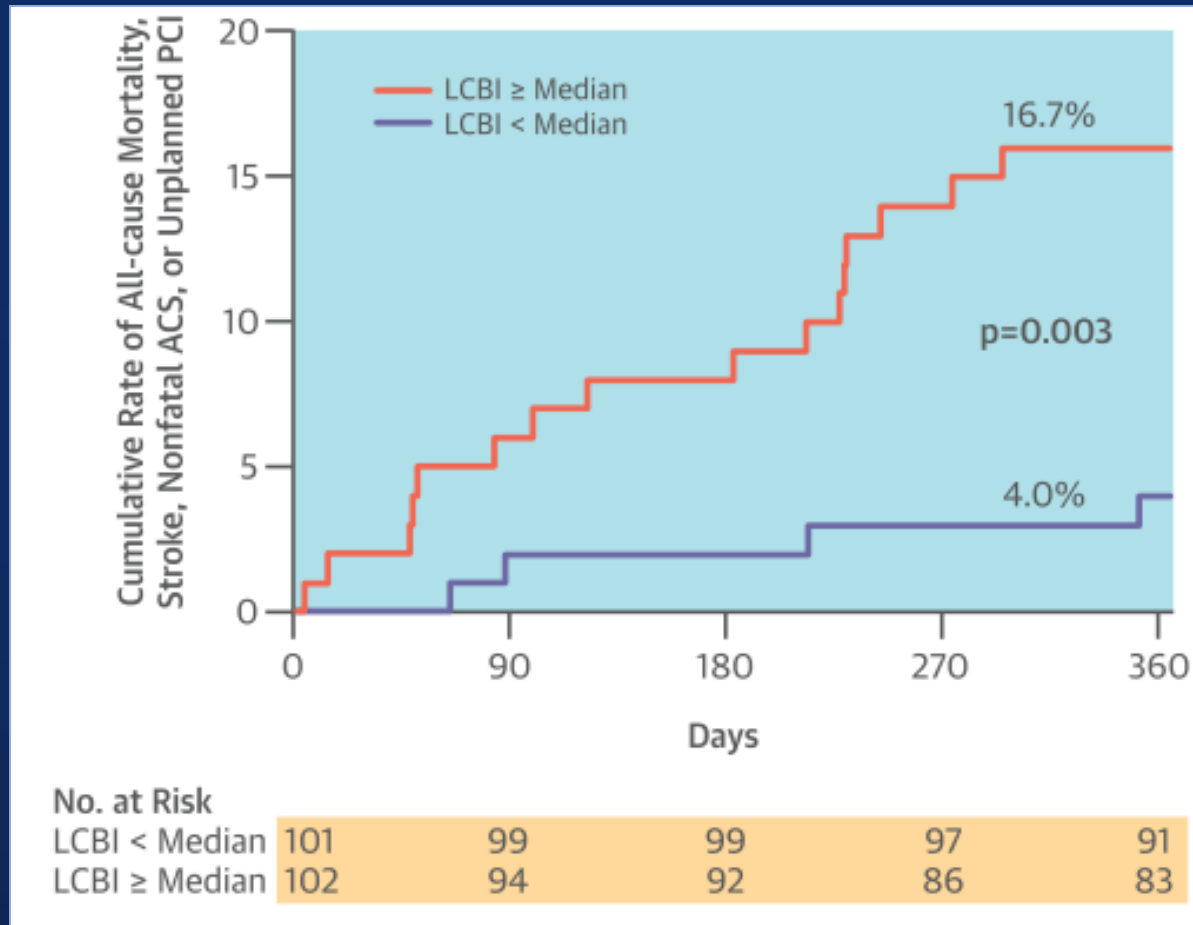

Adjusted HR 4.04 95% CI:1.3-12.3 p=0.01

Relationship between Lipidic Plaque detected by NIRS and Outcomes

ORACLE-NIRS registry

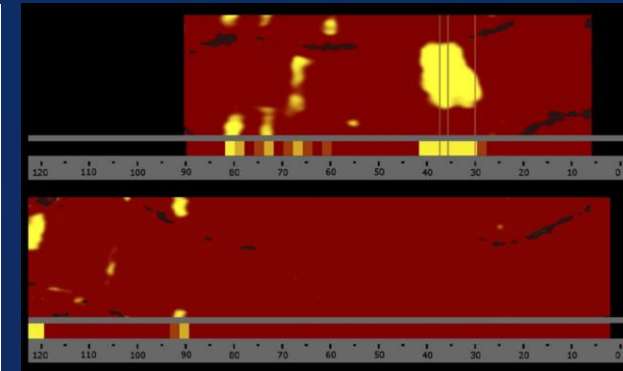
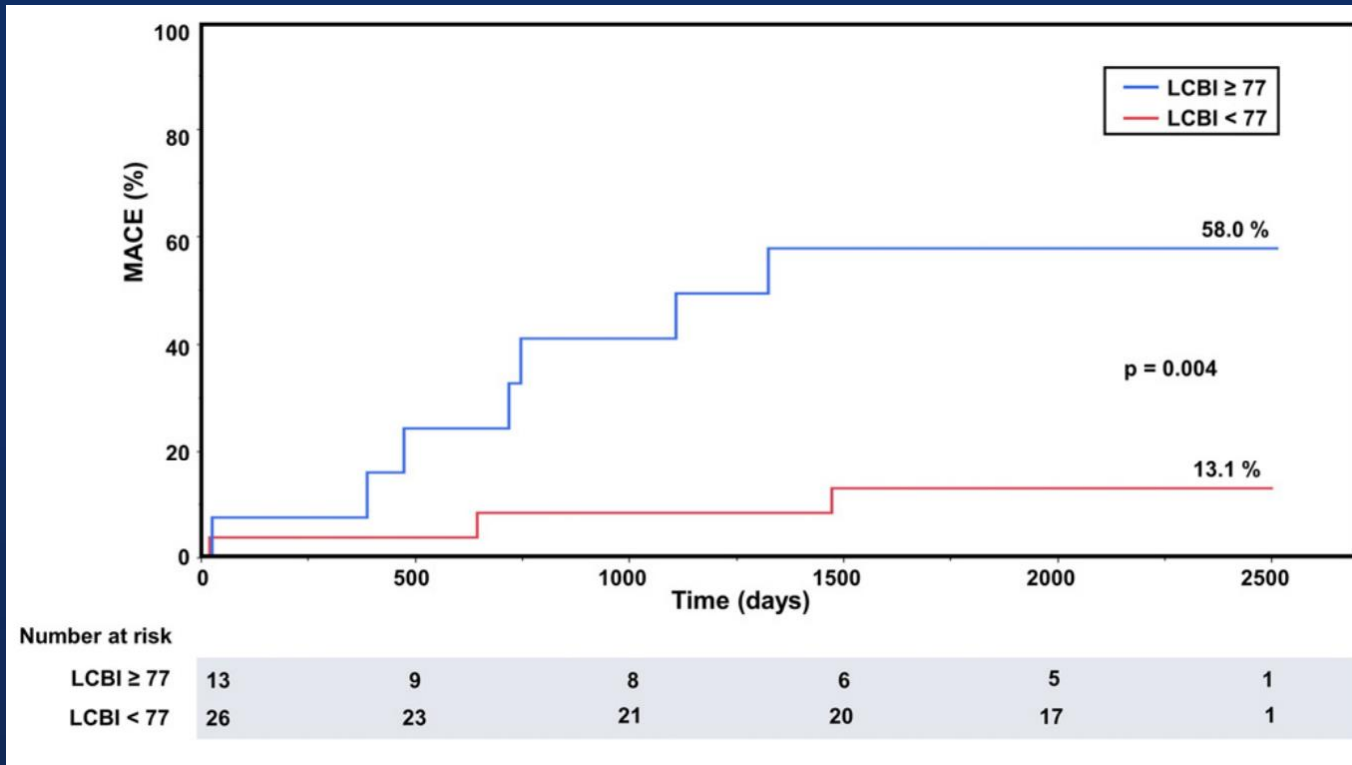

Relationship between Lipidic Plaque detected by NIRS and Outcomes

ATHEROREMO-NIRS and IBIS-3-NIRS substudy

- AATHEROREMO-NIRS
n= 203 (Apr 2009 – Jan 2011)
- IBIS-3-NIRS
n= 131 (Jan 2010 – Jun 2013)
- Diagnostic CAG or PCI for ACS and SAP
- Median follow-up : 4.1 yrs

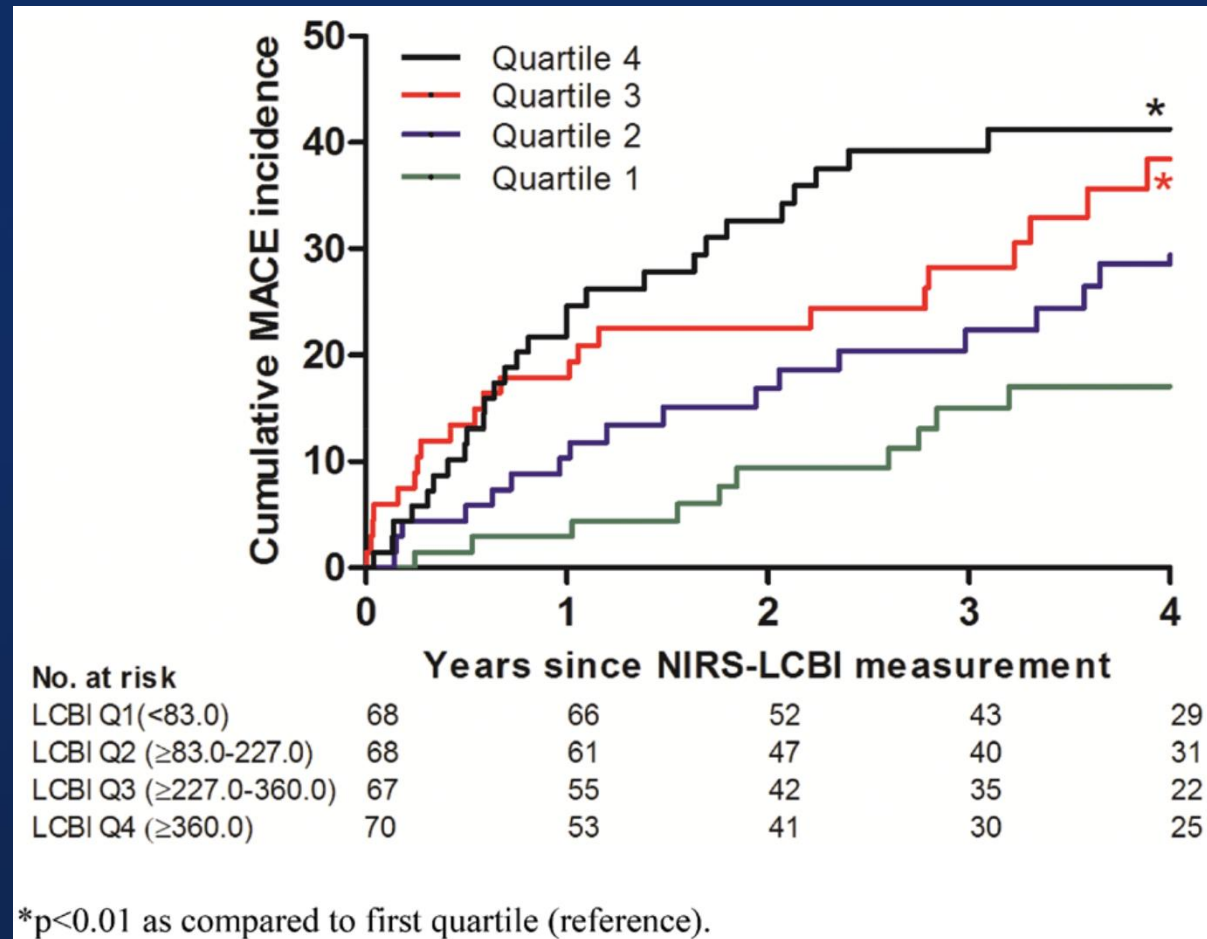

Schumann et al Eur Heart J. 2018 Jan 21;39(4):295-302.

Capabilities of Coronary Imaging Techniques

	CAG	Angioscopy*	OCT*	IVUS	NIRS
Lipid Core		○	○	○	●
Expansive Remodeling				●	
Plaque Burden				●	
Calcification	○		○	●	
Lumen Dimension	○		●	●	
Stent Apposition/Expansion	○		●	●	
Thin Cap		○	●	○	○
Thrombus	○	●	●	○	○

● Direct, robust, and/or validated

○ Indirect, inferred from signal dropout, debated and/or unvalidated

* Require blood-free field of view

Angio vs. IVUS vs. OCT/OFDI

Meta analysis

All cause mortality

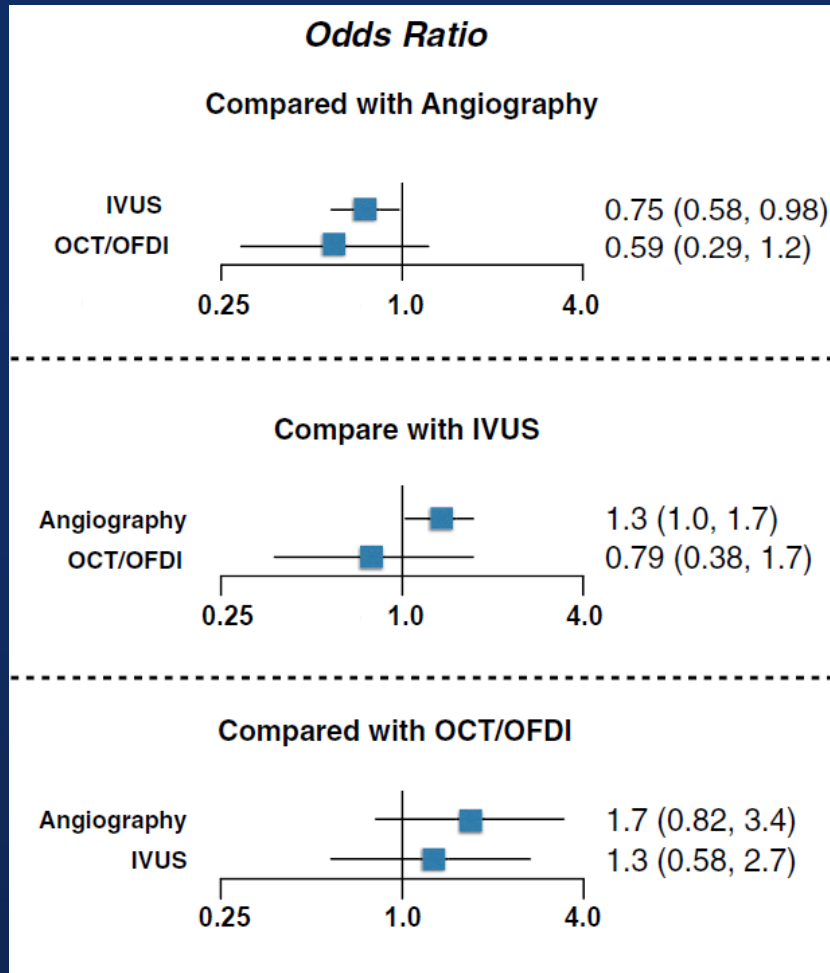

	Angiography	IVUS	OCT/OFDI
MACE			
Angiography	-	0.79 (0.67-0.91)	0.68 (0.49-0.97)
IVUS	1.30 (1.10-1.50)	-	0.87 (0.61-1.30)
OCT/OFDI	1.50 (1.00-2.00)	1.10 (0.78-1.60)	-
Cardiovascular death			
Angiography	-	0.47 (0.32-0.66)	0.31 (0.13-0.66)
IVUS	2.10 (1.50-3.10)	-	0.66 (0.27-1.50)
OCT/OFDI	3.20 (1.50-7.60)	1.50 (0.66-3.70)	-
MI			
Angiography	-	0.74 (0.58-0.90)	0.66 (0.35-1.20)
IVUS	1.40 (1.10-1.90)	-	1.10 (0.60-2.10)
OCT/OFDI	1.30 (0.72-2.30)	0.90 (0.47-1.70)	-
TLR			
Angiography	-	0.74 (0.58-0.90)	0.66 (0.35-1.20)
IVUS	1.40 (1.10-1.70)	-	0.88 (0.47-1.60)
OCT/OFDI	1.50 (0.83-2.90)	1.10 (0.61-2.10)	-
Stent thrombosis			
Angiography	-	0.42 (0.20-0.72)	0.39 (0.10-1.20)
IVUS	2.40 (1.40-5.10)	-	0.93 (0.24-3.40)
OCT/OFDI	2.60 (0.80-10.0)	1.10 (0.29-4.20)	-

Optical Coherence Tomography Versus Intravascular Ultrasound and Angiography to Guide Percutaneous Coronary Interventions

The iSIGHT Randomized Trial

	Angio-Guided PCI	IVUS-Guided PCI	OCT-Guided PCI
Step 01. Selection of vessel references (landing zones)	Regions with largest lumen diameters proximal and distal to the stenosis. Aim to cover from “ shoulder-to-shoulder ”.	Regions with largest lumen areas proximal and distal to the stenoses with plaque burden <50% .	Regions with largest lumen areas proximal and distal to the stenosis; should be lipid-free regions
Step 02. Quantify proximal and distal vessel reference diameters	Visual estimation of maximum lumen diameter at each reference.	<ul style="list-style-type: none"> • EEM $\geq 180^\circ$ + plaque burden <50%: mean EEM diameter; • EEM <180° and/or plaque burden >50%: maximum lumen diameter. 	<ul style="list-style-type: none"> • EEM $\geq 180^\circ$: mean EEM diameter; • EEM <180°: maximum lumen diameter
Step 03. Selection of stent diameter	<p>Discrepancy > 0.5 mm between proximal and distal reference diameters?</p> <div style="display: flex; justify-content: space-around; align-items: center;"> <div style="text-align: center;"> <p>Yes</p> <p>Use diameter of smaller reference</p> </div> <div style="text-align: center;"> <p>No</p> <p>Use diameter of larger reference</p> </div> </div>		
Step 04. Selection of stent length	Distance between distal and proximal references		
Step 05. Post-dilation	<ul style="list-style-type: none"> • Discrepancy > 0.5 mm between proximal and distal reference diameters: use NC balloons sized to each reference diameter; • Discrepancy < 0.5 mm between proximal and distal reference diameters: use NC balloon sized to the largest reference diameter. 		
Step 06. Expansion criteria	Residual stenosis < 10%	Minimum stent area \geq 90% average reference lumen area	

Primary Endpoint

Non-inferiority of OCT-guided PCI to IVUS-guided PCI

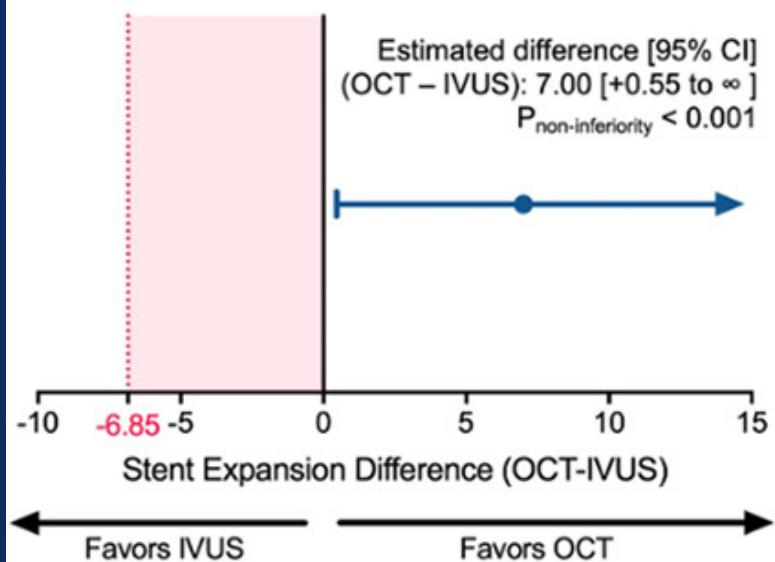

Secondary Endpoints

exploratory superiority testing

